

Horse and Rider 2025

Your Animal Experts







1st place in the Stall Requirements category - Kerbl



Riding Wear

Tournament Wear	6 - 7
Women's and Children's Outerwear	8 - 13
Women's Riding Breeches	14 - 24
Men's Outerwear	25 - 26
Men's Riding Breeches	27
Boots and shoes	28 - 32
Socks	33 - 34
Riding Accessories	35
Riding Gloves	36 - 39

Personal Protective Equipment **40 - 46**

Helmets	40 - 43
Safety Waistcoats	44 - 45
Back Protector	46

Riding Equipment **47 - 110**

Whips	47 - 51
Saddles	52
Saddle Pads	53 - 55
Saddle Cushions and Saddle Straps	56 - 59
Stirrups, Straps and Bits	60 - 61
Bridles and Reins	62 - 67
Lunging Supplies	68 - 70
Riding Safety	71 - 73
Halters and Tethers	74 - 85
Horse Blankets	86 - 96
Eye and Ear Protection	97 - 100
Horse Boots and Bandages	101 - 107
Tournament Accessories	141, 206 - 207
CovallieroTherm	108 - 110

Care Products **111 - 140**

Horse Care	111
MagicBrush	112 - 122
Grooming	123 - 136
Grooming Boxes	137 - 140



Leather Care **142 - 144**

Hoof Care **145 - 160**

Care Materials	145 - 146
Tools	147 - 152
Binding, Hygiene and Disinfection	153 - 160

Horsefly and Insect Protection **161 - 165**

Feed **166 - 172**

Pharmaka supplementary feed	166
Delizia Supplementary Feed	167 - 170
Licks and Lick Holders	171 - 172

Stable Equipment **173 - 286**

Occupation	173 - 175
Clippers Aesculap	176 - 189
Clippers & Accessories	190 - 195
Horse Monitoring	196 - 205
Saddle Cabinets, Saddle and Bridle Racks	208 - 212
Feed Troughs and Buckets	213 - 222
Stable Accessories	223, 241 - 259
Hay Racks and Hay Nets	224 - 231
Litter Forks	232 - 236
Shovels	237 - 239
Brooms	240
Drinking Bowls	260 - 270
Frost-Protection Drinking Bowls	271 - 273
Frost-Protection Accessories	274 - 277
Pasture Gates and Fence Panels	278 - 283
Feeders	284 - 286

Pest Control **287 - 292**

Electric Fly Killers	288 - 290
Fly and Insect Control	287, 291 - 292





Breathability

In technical materials, breathability refers to the ability to allow water vapour to escape. The fibres wick the moisture away from the skin very quickly. Breathability is measured in grams (g) of water vapour per square metre (m²) over 24 hours.

For a breathability of 5000 in 24 hours, for example, 5000 g of water vapour exits through one square metre of this fabric.



Each layer of this clothing is designed to make it easier for the body to maintain a constant temperature.

The task of the interior material is to wick moisture away from the body and transfer it to the next layer.

Thus the body can maintain a constant temperature.

The middle layer effectively regulates body heat. The materials used here are optimal for wicking moisture to the outside and effectively surrounding the body in a warm cushion of air.

The outermost layer of the layered clothing protects against wind, water and snow, while maintaining optimum breathability at the same time. This layer also retains body heat.



Waterproof

The so-called water column rating in mm is the index for watertightness. It indicates the water pressure at which a surface becomes permeable to water. The DIN standard for the "waterproof" label is a water column rating of 1300 mm. The seams of products with this symbol are also waterproof.



wicking

The fibre is specially treated so that moisture is quickly transported to the outside and the body is not cooled down!



Water-resistant

Textiles that have either a special surface treatment or a membrane count as water-repellent. Products with this symbol generally have a waterproof upper material and a water column, the seams are however not waterproof. Sealing the many seams of quilted-look products in particular is not possible.



quick-drying

Fast-drying material because the fibre does not absorb any moisture, but conducts it to the outside instead!



Windproof

The penetration of wind cools down the body because the warm air layer is "blown away". This makes the outside temperature feel colder than it actually is (wind chill effect).



Recycled

The material consists entirely or partially of recycled fibres, mainly recovered from old materials. The warp, weft or both threads can be made from recycled raw materials.



Stretch

Perfect fit

The material is elastic, moving as you move.



Organic Cotton

Organic Cotton

The cotton yarn comes from organically produced cotton.



Feather-light

Here, very lightweight material is transformed into extremely durable and comfortable functional clothing.

How to measure your horse blanket correctly!

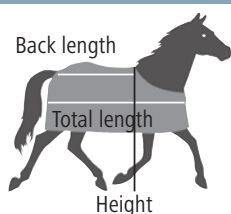

Floor measure	Back length
up to 110 cm	85 cm
up to 120 cm	95 cm
up to 130 cm	105 cm
up to 140 cm	115 cm
up to 150 cm	125 cm
up to 160 cm	135 cm
up to 170 cm	145 cm
from 170 cm	155 cm
Over 175 cm	165 cm

Halter sizes:

00	Foal/miniature Shetland (foal)
0	Shetland pony (P1)
1	Pony (P2)
2	Thoroughbred (cob)
3	Warmblood (full)
4	large warmblood (XFull)
5	Coldblood (XXFull)

Clothing sizes, women

DE	32	34	36	38	40	42	44	46
FR	34	36	38	40	42	44	46	48
IT	38	40	42	44	46	48	50	52
ES	38	38	40	42	44	46	48	50
UK	6	8	10	12	14	16	18	20
Inches	25	26	27/28	28/29	30/31	32/33	34/35	36/37
INTL	XXS	XS	S	M	L	XL	XXL	XXXL

Clothing sizes, children

DE	116	122	128	134	140	146	152	158	164	170	176
FR	6	7	8	9	10	11	12	13	14	15	16
IT	6	7	8	9	10	11	12	13	14	15	16
ES	6	7	8	9	10	11	12	13	14	15	16
UK	6	7	8	9	10	11	12	13	14	15	16
Inches	20	21	22	23	24	25	26	27	28	29	29
INTL	XS	XS	S	S	M	M	L	L	XL	XXL	XXL

Clothing Sizes Men (Trousers)

EU	42	44	46	48	50	52	54	56	58	60
FR	36	38	40	42	44	46	48	50	52	54
Inches	30	31	32	33	34	36	38	40	42	44
INTL	XXS	XS	S	M	M	L	L	XL	XXL	XXXL

Clothing Sizes Men (Outerwear)

EU	42	44	46	48	50	52	54	56	58	60
INTL	XXS	XS	S	M	M	L	L	XL	XXL	XXXL

Glove sizes

XXS	5
XS	6
S	7
M	8
L	9
XL	10
XXL	11
XXXL	12

INTL = International

Explanation of our packaging and sales units.

MOQ	Pieces / unit	€
1 blister pack	Pack of 6	Price per pack
1 pouch	Pouch of 10	Price per pouch
12 items	Pouch of 12	Price per item
1 pack	Pack of 30	Price per pack
40 items	Pack of 40	Price per item
1 box	Box of 5	Price per box
8 items	Box of 8	Price per item
1 display	Display of 10	Price per display
6 items	Display of 6	Price per item



OU

Order unit for retail

Always order a multiple of the number stated (e.g. OU = 12 items, order in lots of 12).

Items/pack unit

No. of items per order unit/ pack unit

Price/€

Price per OU

If the OU column is empty or missing, the price is per item. All prices provided are the manufacturer's recommended retail prices and are inclusive of VAT.



1/10/100

Pack units

Possible pack units for 1 OU.



12

Pallet

No. of order units (OU) per pallet.



Forwarder

All items marked with this icon must be shipped by freight carrier due to their scale/size or weight. This means that additional, separate freight costs are required! Optimise freight costs by ordering entire pallet units.

Warranty

The warranty information in this catalogue is based on the general warranty conditions of Albert Kerbl GmbH. The current version of the general warranty conditions can be found at: <https://www.kerbl.com/guarantee>. These can also be sent electronically or by post on request.

Better product presentation with videos, 360° photo player and downloads

Product videos

You can now find out even more about our products in appealing, informative and attractive product videos.



All features and functions are shown live in action. We also present areas of use that some people may previously have been unaware of. Explanatory and installation videos facilitate operation and clarify features. In this way, we are trying to answer questions on products in advance and also provide you with real added value.

Product images

While we can only show you basic illustrations of a product in our catalogue, we can also provide you with digital copies of further photos showing detailed views and usage, for example.

360° photo player

We are also offering complete 360° views of selected products in addition to our high-resolution professional product photos.



This gives you the option of viewing the product in advance from all sides and in extreme close-up, in high resolution and in sharp focus. Although you still cannot touch it, you can get a much better, more realistic feel for the product.

3D showroom

We would be happy to talk to our customers in person and show them our products. Unfortunately, however, this is not always possible. With our digital showroom, we would like to offer you the opportunity to make your own comprehensive impression of the product range. In our 3D showroom, you can immerse yourself in the worlds of Kerbl products.

Downloads

You will find downloads beneath the product description. Here, you will find further information such as user guides.



@kerbl.fr



Albert Kerbl GmbH



@kerbl.de

Kerbl goes Social Media

You too can find us on social media, on Facebook, Instagram and YouTube. This way, you won't miss out on Kerbl's latest news about our company, products and activities.

You can find an overview of all social media channels at: <https://www.kerbl.de/socialmedia>

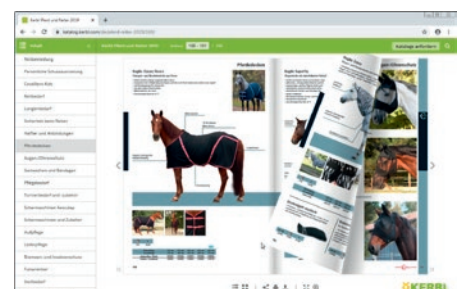



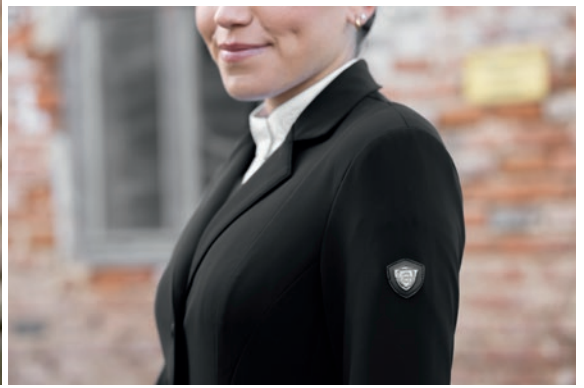

Show Jacket Parigo

- elastic and breathable fabric quality for a perfect fit
- with 4-button trim and concealed zip
- with two decorative pockets
- two vents to the back
- machine washable at 30 °C

New product

NEW

Children's sizes

€	Size	140/146	152/158	164/170
1/20	black	3230310	3230311	3230312

Women's sizes

€	Size	XXS	XS	S	M	L	XL	XXL
1/20	black	3230313	3230314	3230315	3230316	3230317	3230318	3230319

Composition	
Outer material	78 % Nylon, 22 % Spandex
Feed	100 % Polyester
Inner layer	100 % Polyester





Competition Shirt

- Stand-up collar with concealed buttons
- Laser print on the sleeve and logo laser print on the back offer stylish functionality
- breathable and moisture-wicking
- close-fitting cut
- 4-way elastic, functional fabric
- machine washable at 30 °C

New product

NEW

Children's sizes

Icon	€	Size	140/146	152/158	164/170
		white	3230320	3230321	3230322
1/35					

Women's sizes

Icon	€	Size	XXS	XS	S	M	L	XL	XXL
		white	3230323	3230324	3230325	3230326	3230327	3230328	3230329
1/35									

Composition

Textile 90 % Polyamide, 10 % Elastane

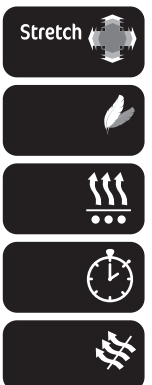

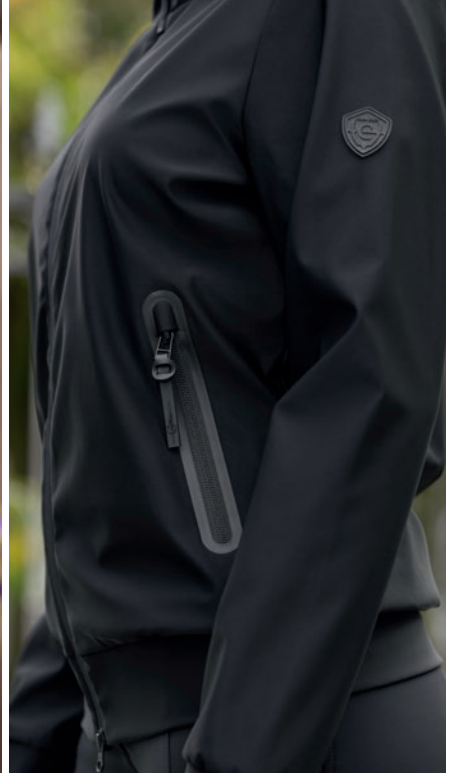

Blouson Jacket

- lining can be separated using a zip fastener to be able to embroider the outer material
- two handwarmer pockets
- water-repellent material with up to a 5000 mm water column
- with 2-way zip fastener
- 800 g/m²/24 h (air permeability)
- machine washable at 30 °C

New product 

Children's sizes

€	Size	140/146	152/158	164/170
1/20	dark navy	3230330	3230331	3230332
	black	3230340	3230341	3230342

Women's sizes

€	Size	XXS	XS	S	M	L	XL	XXL
1/20	dark navy	3230333	3230334	3230335	3230336	3230337	3230338	3230339
	black	3230343	3230344	3230345	3230346	3230347	3230348	3230349

Composition

Outer material	88 % Nylon, 12 % Elastane
Membrane	100 % TPU (thermoplastic polyurethane)
Feed	100 % Polyester

5000 mm 

800 g/m²/24 h 

Stretch 



Active Jacket

- highly elastic material
- two handwarmer pockets with zips
- with 2-way zip
- machine washable at 30 °C

New product 

€	Size	XS	S	M	L	XL	XXL
1/30	dark navy	3230350	3230351	3230352	3230353	3230354	3230355

Composition
Textile 80 % Polyester, 20 % Elastane





Active Shirt

- an attractive, sporty long-sleeved shirt for layering
- elastic material with close cut
- Slim fit
- stand up collar with a zip fastener
- breathable and lightweight
- machine washable at 30 °C

Covalliero recycling!

- the polyester used comes from recycled textiles



1/50	€	Size	XXS	XS	S	M	L	XL	XXL	
		white	3230120	3230121	3230122	3230123	3230124	3230125	3230126	NEW
		navy	3297562	3297563	3297564	3297565	3297566	3297567	3297568	

Composition

Textile 88 % Polyester (recycled), 12 % Elastane





Polo shirt

Polo shirt made from recycled functional fabric that is not only great to wear, but also great for the environment.

- 2-button placket
- breathable and moisture-wicking
- 4-way elastic, functional fabric
- close-fitting cut
- machine washable at 30 °C

Covalliero recycling!

- the polyester used comes from recycled textiles



€	Size	XXS	XS	S	M	L	XL	XXL
1/40	graphite	3224508	3224509	3224510	3224511	3224512	3224513	3224514
	navy	3226253	3226254	3226255	3226256	3226257	3226258	3226259

Composition	Textile
	88 % Polyester (recycled), 12 % Elastane



Raincoat

- waterproof rain coat with hood
- 10,000 mm watercolumn with taped seams
- waterproof 2-way Zip Fastener
- riding slit with zip
- Sleeve width adjustable with hook-and-loop fastener
- reflective applications
- two handwarmer pockets
- includes inner pocket
- 3000 g/m²/24 h (air permeability)
- machine washable at 30 °C

	€	Size	XS	S	M	L	XL
 1/20		navy	3223380	3223381	3223382	3223383	3223384

Composition	
Textile	100 % Polyester
Membrane	100 % TPU (thermoplastic polyurethane)

10000 mm 

3000 g/m²/24 h 



Rain Poncho

- specially developed riding rain poncho in a unisize
- buttons at neck opening and sides
- incl. large hood that can also cover a helmet
- bonded seams and PU coating ensure it is 100 % waterproof
- special foot straps prevent the poncho from lifting when riding
- 5000 g/m²/24 h (air permeability)

Ref. no.	Colour		€
3211679	blue	1/25	

Composition	
Textile	100 % Polyester



5000 g/
m²/24 h 

10000 mm 



„My team and I have tested the riding breeches intensively in everyday stable settings as well as at international competitions. It's important to me that I feel completely comfortable in my riding breeches and that they fit so well that I can also go shopping quickly after riding.

As a long-time brand ambassador for Pink Ribbon, it is a matter close to my heart that we also draw attention to and support the important issue of early breast cancer detection by selling my own riding breeches, which I helped to develop myself. For every pair of riding breeches sold, 5 % of the retailer price goes as a donation to Pink Ribbon Germany.

My brand logo in pink at the leg hem of the riding breeches represents the mutually trusting cooperation between Pink Ribbon Germany, Covalliero and me, and hopefully has a high recognition value to draw attention to the importance of early breast cancer detection.“

We are proud to present you the first „Janne“ riding breeches and hope that you are as excited by them as we are!

Have fun riding!
The Covalliero Team,
Pink Ribbon and Janne.

Janne





Riding Breeches Janne x PinkRibbon

- two front handwarmer pockets
- patch pocket appliqués at the back
- particularly dimensionally stable
- high wearing comfort due to very soft and light material
- functional properties, such as breathability, climate regulation, elasticity, combined with an optimised fit
- ElastoSoft leg hem with the Janne x Pink Ribbon logo as a visual highlight
- 4-way elastic
- water-repellent, dirt-repellent, wind-deflecting
- machine washable at 30 °C



Knee patch with Janne grip

1/20	€	Size	32	34	36	38	40	42	44	46
		dark navy	3224667	3224668	3224669	3224670	3224671	3224672	3224673	3224674
		white pearl	3224675	3224676	3224677	3224678	3224679	3224680	3224681	3224682
		graphite	3224683	3224684	3224685	3224686	3224687	3224688	3224689	3224690

Full seat with Janne grip

- The Janne riding breeches are now available with full seat. They are manufactured from the same high-quality material that you know from the padded knee breeches.

1/20	€	Size	32	34	36	38	40	42	44	46
		dark navy	3228110	3228111	3228112	3228113	3228114	3228115	3228116	3228117
		white pearl	3228118	3228119	3228120	3228121	3228122	3228123	3228124	3228125
		graphite	3228126	3228127	3228128	3228129	3228130	3228131	3228132	3228133

Composition

Textile	77 % Polyamide, 23 % Elastane
Anti-slip Print	100 % Silicon
ElastoSoft leg cuffs	89 % Polyester, 11 % Elastane

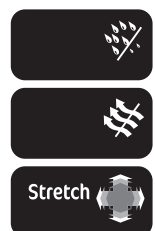



Riding Tights HighWaist

The high-cut riding leggings with full seat ensure a secure fit in the saddle with full freedom of movement. The sophisticated design with 4-way stretch guarantees the best fit even after repeated washing.

- classic, all-year-round riding leggings made from ultra-elastic microfibre with high waistband
- extra-wide and comfortable feel-good waistband without zip fastener
- practical mobile phone pocket on both sides
- high-waist cut for maximum wearing comfort
- patch back pockets with glitter appliqué
- dimensionally stable thanks to superlative quality
- full seat with Covalliero grip
- 4-way elastic
- machine washable at 30 °C



1/20	€	Size	32/34	34/36	36/38	38/40	40/42	42/44	44/46
		black	3228286	3228287	3228288	3228289	3228290	3228291	3228292
		dark blue	3230134	3230135	3230136	3230137	3230138	3230139	3230140

NEW

Composition	
Textile	71 % Polyamide, 29 % Elastane
Anti-slip Print	100 % Silicon

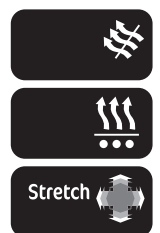



Riding Breeches HighWaist

The high-cut riding breeches with full seat ensure a secure fit in the saddle, with full freedom of movement. The sophisticated design with 4-way stretch guarantees the best fit even after repeated washing.

- classic, all-year-round riding breeches made from ultra-elastic microfibre, with high waistband
- extra wide and comfortable feel-good waistband
- practical mobile phone pocket on both sides
- high-waist cut for maximum wearing comfort
- patch back pockets with glitter appliqué
- dimensionally stable thanks to superlative quality
- full seat with Covalliero grip
- 4-way elastic
- machine washable at 30 °C



New product

NEW

€	Size	34	36	38	40	42	44	46
1/20	black	3230127	3230128	3230129	3230130	3230131	3230132	3230133

Composition

Textile	71 % Polyamide, 29 % Elastane
Anti-slip Print	100 % Silicon

Stretch





Riding Breeches BasicPlus Jodhpur

Our BasicPlus Jodhpur Riding Breeches with a new design in tried and tested quality!
The ideal alternative for female riders who prefer a casual style in the saddle.

- the classic in a new design
- with practical mobile phone pocket on both sides for even more storage space
- shape-retaining fabric with excellent comfort thanks to the cotton content
- leg cuff with elastic strap
- full seat made of stretchable textile leather
- 4-way elastic
- machine washable at 30 °C

New product 

	€	Size	34	36	38	40	42	44	46
1/20		navy	3230356	3230357	3230358	3230359	3230360	3230361	3230362
		graphite	3230363	3230364	3230365	3230366	3230367	3230368	3230369

Composition	
Textile	73 % Cotton, 25 % Polyester, 2 % Elastane
Trim	60 % Polyamide, 40 % polyurethane





Riding Breeches Economic

The beginners' all-season breeches leave nothing to be desired for novices and budget-conscious buyers!

- form-fitting cut, with 4-way stretch for perfect comfort while wearing
- Belt loops and non-slip elasticated waistband
- skin-friendly comfort with natural cotton fabric
- with one zipped pocket
- full seat made of stretchable textile leather
- leg cuff ElastoSoft
- machine washable at 30 °C

Children's sizes

1/25	€	Size	116	122	128	134	140	146	152	158	164	170	176
		blackberry	3210130	3210131	3210132	3210133	3210140	3210141					
		black	324406	324407	324408	324409	324410	324411	324412	324413	324414	324415	324416
		blue	324425	324426	324427	324428	324429	324430	324431	324432	324433	324434	324435
		dark rose	325852	325853	325854	325855	325856	325857					

Women's sizes

1/25	€	Size	32	34	36	38	40	42	44	46
		black	324424	324417	324418	324419	324420	324421	324422	324423
		blue	324443	324436	324437	324438	324439	324440	324441	324442
		wood	324444	325863	325864	325865	325866	325867	325868	325869

Composition

Textile	90 % Cotton, 10 % Elastane
Trim	60 % polyurethane, 40 % Polyester
ElastoSoft leg cuffs	89 % Polyester, 11 % Elastane





Riding Breeches ClassicStar

- classic, all-year-round riding breeches made from ultra-elastic microfibre
- practical mobile phone pocket
- normal waistband height (regular rise) for superb wearing comfort
- full seat with Covalliero grip
- 4-way elastic
- machine washable at 30 °C



	€
1/25	

Size	32	34	36	38	40	42	44	46
navy	3224691	3224692	3224693	3224694	3224695	3224696	3224697	3224698
graphite	3224699	3224700	3224701	3224702	3224703	3224704	3224705	3224706

Composition	
Textile	90 % Polyester, 10 % Elastane
Anti-slip Print	100 % Silicon





Riding Tights ClassicStar

- classic, all-year-round riding leggings made from ultra-elastic microfibre
- extra-wide and comfortable waistband without zip fastener
- practical mobile phone pocket
- medium high-waist cut for maximum wearing comfort
- full seat with Covalliero grip
- 4-way elastic
- machine washable at 30 °C

Children's sizes:

€	Size	128/134	140/146	152/158	164/170
1/25	navy	3224707	3224708	3224709	3224710
	graphite	3224718	3224719	3224720	3224721
	white	3225357	3225358	3225359	3225360
	black	3230141	3230142	3230143	3230144 NEW

Women's sizes:

€	Size	32/34	34/36	36/38	38/40	40/42	42/44	44/46
1/25	navy	3224711	3224712	3224713	3224714	3224715	3224716	3224717
	graphite	3224722	3224723	3224724	3224725	3224726	3224727	3224728
	white	3225361	3225362	3225363	3225364	3225365	3225366	3225367
	black	3230145	3230146	3230147	3230148	3230149	3230150	3230151 NEW

Composition	
Textile	90 % Polyester, 10 % Elastane
Anti-slip Print	100 % Silicon





Riding Tights Equona

Developed for female riders who are looking for light, extremely elastic riding leggings and who can do without all the unnecessary extras. Equona really shows off its advantages in warm and hot summer months when thick and heavy materials just don't cut it! The full seat made of non-slip print ensures the best contact with the saddle.

- practical mobile phone pocket
- full seat with Covalliero grip
- 4-way elastic
- machine washable at 30 °C

Low-rise cut

Children's sizes

€	Size	116/122	128/134	140/146	152/158	164/170
1/20	dark blue	3297618	3297619	3221992	3221993	3221994
	black	3297620	3297621	3222002	3222003	3222004

Women's sizes:

€	Size	32/34	34/36	36/38	38/40	40/42	42/44	44/46
1/20	dark blue	3221995	3221996	3221997	3221998	3221999	3222000	3222001
	black	3222005	3222006	3222007	3222008	3222009	3222010	3222011

Composition

Textile 89 % Polyester, 11 % Elastane
 Anti-slip Print 100 % Silicon





Thermo Riding Skirt

NEW: Our classic thermal riding skirt is now equipped with a practical zip fastener that makes it easy to put on and take off. The leg loops also ensure that the skirt always stays in place. The perfect harmony between the warming fleece lining and the water-resistant yet breathable outer material guarantees maximum comfort. The thermal skirt from Covalliero is the ideal solution and a real must-have for riders!

- hard-wearing polyester-Oxford material
- warm fleece waistband with hook-and-loop fastener
- extremely water-repellent up to a 5000 mm water column
- breathable to 2000 g/m²/24 h
- windproof
- machine washable at 30 °C





Available from: August 2025

 €	Size	34-38	40-46
	navy	3230370	3230371

Composition	
Outer material	100 % Polyester
Membrane	100 % TPU (thermoplastic polyurethane)
Feed	100 % Polyester



New product 

- 
- 
- 
- 



Thermal Overtrousers Alaska 2.0

The perfect overpants, made from soft shell outer material with a thermal function, for bitterly cold days.

New product

- 2-way elastic thanks to Supersoft soft shell
- Easy to pull on thanks to fully-opening zip fasteners on both outer sides of the legs
- with non-slip full seat for good saddle contact
- Flexible cuff width adjustment with hook and loop fastener and elastic cord
- extremely water-repellent up to a 8000 mm water column
- Compact 80 gsm thermal fleece lining warms without adding bulk
- additionally integrated snow guard with elastic cuff in the leg cuff prevents the penetration of water or snow
- breathable to 3,000 gsm/24 h
- machine washable at 30 °C

Children's sizes

€	Size	128/134	140/146	152/158	164/170
1/10	black	3230372	3230373	3230374	3230375

Women's sizes

€	Size	S	M	L	XL	XXL
1/10	black	3230377	3230378	3230379	3230380	3230376

Composition	
Outer material	94 % Polyester, 6 % Elastane
Feed	100 % Polyester
Inner layer	100 % Polyester
Trim	60 % polyurethane, 40 % Polyester

- Stretch**
-
- 8000 mm**
- 3000 g/m²/24 h**
- Thermo**

Available from: August 2025





Blouson Jacket

- lining can be separated using a zip fastener to be able to embroider the outer material
- two handwarmer pockets
- water-repellent material with up to a 5000 mm water column
- with 2-way zip fastener
- 800 g/m²/24 h (air permeability)
- machine washable at 30 °C

New product 

	€	Size	S	M	L	XL	XXL	XXXL
1/20		dark navy	3230381	3230382	3230383	3230384	3230385	3230386

Composition	
Textile	80 % Nylon, 12 % Elastane
Membrane	100 % TPU (thermoplastic polyurethane)
Feed	100 % Polyester

-  Stretch
-  800 g/m²/24 h
-  5000 mm



Polo shirt

Polo shirt made from recycled functional fabric that is not only great to wear, but also great for the environment.

- 3-button placket
- breathable and moisture-wicking
- 4-way elastic, functional fabric
- close-fitting cut
- machine washable at 30 °C

Covalliero recycling!

- the polyester used comes from recycled textiles

	€	Size	S	M	L	XL	XXL	XXXL
 1/40		graphite	3224515	3224516	3224517	3224518	3224519	3224520
		navy	3226260	3226261	3226262	3226263	3226264	3226265

Composition

Textile 88 % Polyester, 12 % Elastane





Riding Breeches Techno II

The men's riding breeches with 4-way stretch and silicone trim offer a perfect fit, maximum freedom of movement and particularly good grip in the saddle.

- maximum wearing comfort & mobility with 4-way stretch fabric and ElastoSoft leg closure
- stylish details with two front and two rear pockets
- shape retention guarantees the perfect fit
- silicone trim for better grip
- machine washable at 30 °C for easy cleaning

knee patches with Covalliero Grip

€	Size	44	46	48	50	52	54
1/20	dark blue	3228134	3228135	3228136	3228137	3228138	3228139

full seat with Covalliero grip

€	Size	44	46	48	50	52	54
1/20	dark blue	3228140	3228141	3228142	3228143	3228144	3228145

Composition	
Textile	77 % Polyamide, 23 % Elastane
Anti-slip Print	100 % Silicon
ElastoSoft leg cuffs	89 % Polyamide, 11 % Elastane

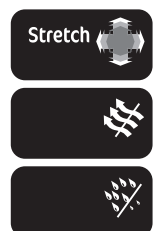

Thermal Boots Classic

- useful protection against winter temperatures
- cosy and warm with faux fur lining
- adjustable shank by hook and loop closure
- waterproof foot section that also fits into stirrups
- easy to clean outer material
- Sizes 26 - 35 with 3 hook and loop fasteners
- Sizes 36 - 45 with 4 hook and loop fasteners

Ref. no.	Colour	Size		€
3222051	black	26	1/6	
3222052	black	27	1/6	
3222053	black	28	1/6	
3222054	black	29	1/6	
3222055	black	30	1/6	
3222056	black	31	1/6	
3222057	black	32	1/6	
3222058	black	33	1/6	
3222059	black	34	1/6	
3222060	black	35	1/6	
3222061	black	36	1/6	
3222062	black	37	1/6	
3222063	black	38	1/6	
3222064	black	39	1/6	
3222065	black	40	1/6	
3222066	black	41	1/6	
3222067	black	42	1/6	
3222068	black	43	1/6	
3222069	black	44	1/6	
3222070	black	45	1/6	



Composition	
Upper material	Textile (100 % polyamide)
Feed	Textile (100 % polyester)
Insole	Other material (100 % EVA)
Outer Sole	other material

Thermal Winter Shoes Ottawa 2.0

A stable and thermal winter shoe with warm faux fur lining for working in the stable and for walking with your horse. The hook and loop closure means you can flexibly adjust it to fit. The thermal shoe is waterproof fitted with an anti-slip and easy-clean treaded sole and is the perfect shoe for any winter weather.



Ref. no.	Colour	Size		€
3210005	black	36	1/10	
3210006	black	37	1/10	
3210007	black	38	1/10	
3210008	black	39	1/10	
3210009	black	40	1/10	
3210010	black	41	1/10	
3210011	black	42	1/10	
3211541	black	43	1/10	
3211542	black	44	1/10	
3211543	black	45	1/10	



Composition	
Upper material	Textile (100 % polyamide)
Feed	Textile (100 % polyester)
Insole	Other material (100 % EVA)
Outer Sole	other material

Riding half-boots Oslo

- elegant boots made from polyurethane
- highly water-repellent
- toasty warm thanks to synthetic fur lining
- easy to clean and maintain



Ref. no.	Colour	Size		€
324555	black	35	1/10	
324556	black	36	1/10	
324557	black	37	1/10	
324558	black	38	1/10	
324559	black	39	1/10	
324560	black	40	1/10	
324561	black	41	1/10	
324562	black	42	1/10	



Composition

Upper material	Textile (100 % polyurethane)
Feed	Textile (100 % polyester)
Insole	Textile (100 % polyester)
Outer Sole	Other material (100 % TPR : caoutchouc thermoplastique)

Boots NeoLite

- ideal for working in stalls or pastures
- sole with self-cleaning profile for a high level of slip resistance
- the heat insulating properties of synthetic rubber also keep feet pleasantly warm in winter
- the low weight and flexible shaft made from synthetic rubber provide an extremely high level of wearing comfort

waterproof foot section

Ref. no.	Description	Colour	Size		€
3210190	mid high	black	36	1/10	
3210191	mid high	black	37	1/10	
3210192	mid high	black	38	1/10	
3210193	mid high	black	39	1/10	
3210194	mid high	black	40	1/10	
3210195	mid high	black	41	1/10	
3222098	mid high	black	42	1/10	
3222099	mid high	black	43	1/10	
3222100	mid high	black	44	1/10	
3222101	mid high	black	45	1/10	
322071	high	black	36	1/10	
322072	high	black	37	1/10	
322073	high	black	38	1/10	
322074	high	black	39	1/10	
322075	high	black	40	1/10	
322076	high	black	41	1/10	
3222071	high	black	42	1/10	
3222072	high	black	43	1/10	
3222073	high	black	44	1/10	
3222074	high	black	45	1/10	



Composition

Shaft	100 % synthetic rubber
Insole	100 % PVC
Base	100 % PVC

Riding half-boots Axona

- easy-to-clean plastic half-boot
- watertight and washable
- elasticated ankle strap
- with anti-slip outsole



Ref. no.	Colour	Size		€
326161	black	31	1/10	
326162	black	32	1/10	
326163	black	33	1/10	
326164	black	34	1/10	
326165	black	35	1/10	
326166	black	36	1/10	
326167	black	37	1/10	
326168	black	38	1/10	
326169	black	39	1/10	
326170	black	40	1/10	
326171	black	41	1/10	
326172	black	42	1/10	



Composition

Upper material	Other material (100 % PVC)
Feed	Textile (100 % polyester)
Insole	Textile (100 % polyester)
Outer Sole	Other material (100 % PVC)

Riding half-boots Leder Classic

- smooth leather
- soft lining for a high level of wearing comfort
- elastic shaft strap eases putting on and off the boot
- anti-slip sole
- elegant and casual in one



Ref. no.	Colour	Size		€
324576	black	35	1/10	
324577	black	36	1/10	
324578	black	37	1/10	
324579	black	38	1/10	
324580	black	39	1/10	
324581	black	40	1/10	
324582	black	41	1/10	
324583	black	42	1/10	
324584	black	43	1/10	
324585	black	44	1/10	
324586	black	45	1/10	



Top Seller



genuine leather



Composition

Upper material	100 % leather
Feed	Textile (100 % polyester)
Insole	Textile (100 % polyester)
Outer Sole	Other material (100 % TPR : caoutchouc thermoplastique)

Riding half-boots Monaco

Elegant lace-up leather riding half-boot, easy-on and -off thanks to additional zip fasteners!

- smooth leather
- soft lining for a high level of wearing comfort
- high-quality, detailed craftsmanship
- elasticated, ensuring easy foot movement
- classic cut, with attractive decorative seams to the front



Ref. no.	Colour	Size		€
324565	black	35	1/10	
324566	black	36	1/10	
324567	black	37	1/10	
324568	black	38	1/10	
324569	black	39	1/10	
324570	black	40	1/10	
324571	black	41	1/10	
324572	black	42	1/10	
324573	black	43	1/10	
324574	black	44	1/10	
324575	black	45	1/10	



genuine leather



Composition

Upper material	100 % leather
Feed	Textile (100 % polyester)
Insole	Textile (100 % polyester)
Outer Sole	Other material (100 % TPR : caoutchouc thermoplastique)

Riding half-boots Vienna

Chic riding half-boot made of soft smooth leather with breathable lining, spur holders and anti-shock sole.

- made from elegant soft smooth leather
- pleasant, breathable inner lining for a high level of wearing comfort
- lace-up boot look with elastic insert for perfect fit
- two zip fasteners for easy putting-on and taking-off
- with spur holders
- with anti-shock sole



Ref. no.	Colour	Size		€
3228146	black	36	1/10	
3228147	black	37	1/10	
3228148	black	38	1/10	
3228149	black	39	1/10	
3228150	black	40	1/10	
3228151	black	41	1/10	
3228152	black	42	1/10	

genuine leather



Composition

Upper material	100 % leather
Feed	Textile (100 % polyester)
Insole	Textile (100 % polyester)
Outer Sole	Other material (100 % TPR : caoutchouc thermoplastique)

Bootjack

- incl. protective rubber inlay • the rubber insert prevents the leather boots from scratching • Material: Plastic

Ref. no.		€
32654	1/50	





Tray for taking off shoes / boots EasyOut

Innovative shoe and boot taking-off tray. Designed for effortless hands-free removal and neat storage of shoes and boots.

- innovative invention as the ultimate, clean and practical solution for removing your shoes and boots
- hands-free removal of boots and shoes
- integrated compartment for collecting mud and dirt
- robust construction and versatile design, suitable for all boots and shoes
- suitable for all boot/shoe sizes
- easy to clean, simply rinse with water
- ideal for house and office entrances, farms, industrial and construction sites
- Material: PPC (polypropylene copolymer)



New product 

Ref. no.	Description	Length	Width			€
329092	for one pair	45,2 cm	28 cm	1/12	384	
329093	for two pairs	45,2 cm	53 cm	1/12	192	

Half Chaps Elasto

- elegant boot shaft made from soft leather adapts perfectly to the shape of the leg
- Elastic insert parallel to the zip ensures optimum freedom of movement
- flawless finish, stable zip fastener and elastic heel strap for reliable use
- approved for tournaments as per the LPO
- smooth leather

Ref. no.	Colour	Size	Height	Range		€
324030	black	S	38 cm	33 cm	1/25	
324031	black	M	40,5 cm	34 cm	1/25	
324032	black	L	43 cm	35,5 cm	1/25	
324033	black	XL	45,5 cm	38 cm	1/25	



genuine leather 



Composition

Textile 100 % non-textile parts of animal origin (cowhide)

Mini Chaps ClassicStretch

- durable faux leather
- with stretch inset for a perfect fit
- easy to clean with water and mild detergent
- elasticated foot strap
- hook and loop fastener shank closure
- with a zip fastener
- machine washable at 30 °C

Children's sizes:

Ref. no.	Colour	Size	Height	Range		€
328770	black	128	32 cm	28 cm	1/25	
328611	black	134	33 cm	30 cm	1/25	
328771	black	140	33 cm	31 cm	1/25	
328612	black	146	34 cm	33 cm	1/25	
328772	black	152	34 cm	34 cm	1/25	



Women's sizes:

Ref. no.	Colour	Size	Height	Range		€
328773	black	XS	35 cm	32 cm	1/25	
328774	black	S	37 cm	32 cm	1/25	
328775	black	M	40 cm	34 cm	1/25	
328776	black	L	41 cm	36 cm	1/20	
328777	black	XL	43 cm	39 cm	1/20	
328778	black	XXL	43 cm	42 cm	1/20	

Composition

Textile 60 % Nylon, 40 % polyurethane

Riding Socks Karo

Pack of 3

- good fit
- with reinforced foot area
- in pairs
- machine washable at 30 °C



MOQ	Pair / VE		€
1 pack	3 / pack	1/40	

Size	34 - 36	37 - 39	40 - 42
navy / stone / wood	3224521	3224526	3224522

Composition	
Textile	75 % Cotton, 20 % Polyester, 5 % Elastane

Riding Socks Brescia

- good fit
- with reinforced foot area
- in pairs
- machine washable at 30 °C



brown / khaki

merlot / graphite

night blue

dark blue

terra

	€
1/5/100	

Size	34 - 36	37 - 39	40 - 42
brown / khaki	3226315	3226316	3226317
merlot / graphite	3226318	3226319	3226320
night blue	320510	320511	320512
dark blue	324210	324211	324212
terra	324216	324217	324218
dark blue / hibiscus red	325309	325310	325311
wood / dark rose	325315	325316	325317
anthracite / grey	325434	325435	325436

Composition	
Textile	75 % Cotton, 20 % Polyamide, 5 % Elastane



dark blue / hibiscus red

wood / dark rose

anthracite / grey

Riding Socks Grado

- thin yet supportive knitting on the shaft for optimal comfort in the boot
- good fit with a fixed but non-restrictive band
- in pairs
- machine washable at 30 °C

MOQ	€	Size	34 - 36	37 - 39	40 - 42
1/5/100		night blue	320519	320520	320521
		black	328606	328607	328608

Composition	
Textile	98 % Polyamide, 2 % Elastane



Riding Socks Flex

Pack of 3

- thin yet supportive knitting on the shaft for optimal comfort in the boot
- Good fit with a fixed but non-restrictive band
- with reinforced foot area
- in pairs
- machine washable at 30 °C

MOQ	Pair / VE	MOQ	€
1 pack	3 / pack	1/50	

Size	34 - 38	39 - 43
navy / stone / wood	3224649	3224650

Composition	
Textile	75 % Cotton, 20 % Polyester, 5 % Elastane



Compression socks Janne

Pack of 2

- lightweight and stretchy for high wearing comfort
- Compression effect to support the muscles
- breathable

MOQ	€
1/75	

Size	34 - 36	37 - 39	40 - 42
black / dark navy	3228077	3228078	3228079

Composition	
Textile	55 % Polyester, 39 % Nylon, 6 % Elastane



Spurs with Straps

• with straps • Material: stainless steel • in pairs



321266



Ref. no.	Size	Spore form	Ø		€
321250	Women	drop-shape	15 mm	1/10/80	
321252	Women	drop-shape	25 mm	1/10/80	
321254	Women	drop-shape	30 mm	1/10/80	
321251	Men	drop-shape	15 mm	1/10/40	
321253	Men	drop-shape	25 mm	1/10/100	
321255	Men	drop-shape	30 mm	1/10/80	

Ref. no.	Description	Colour	Material	Length	Width	packaged		€
321266	Spur straps with simple round buckle	black	Polyamide	50 cm	15 mm	in pairs	1/200/500	

Spurred Boot Protectors

• soft rubber protects the boots from abrasion and damage • for a better fit for the spurs • with pin recess • for all sizes, can be shortened
• without spurs • in pairs



Ref. no.	Colour	MOQ	Pieces / unit		€
324463	black	4 pair	4 / pack	1/4/252	

Sporty Hold Spray

THE anti-slip formula!

Provides a secure grip for beginner and professional riders alike.

• to improve thigh position and seat • ideal grip on the crupper and the vaulting pad

Ref. no.	Contents		€
32562	200 ml / Spray Can	1/10	



Hypofekt

• Usage: Wipe down the zip, spray with HYPOFEKT, leave briefly to work, then repeatedly open and close.
• Jamming and dirty zips are now a thing of the past! • perfect cleaning and care for zips – for long-lasting functionality

Ref. no.	Contents		€
32585	50 ml / Spray Can	1/12	



Riding Gloves Ulanta

- extremely durable and soft PU materials for excellent rein grip
- back of the hand made from recycled PET bottles - breathable and moisture-wicking
- close-fitting glove with excellent fit
- elasticated wrist section for maximum wearing comfort
- machine washable at 30 °C



recycled back of the hand made from PET bottles

€	Glove Size	5 / XXS	6 / XS	7 / S	8 / M	9 / L	10 / XL
1/12/72	black	3226321	3226322	3226323	3226324	3226325	3226326

Composition

Back of the hand	100 % Polyester (recycled)
Palm of the hand	100 % polyurethane

Riding Gloves Antana

- perfect fit
- inner hand with particularly good grip and non-slip properties
- hook and loop fastener at the wrist
- machine washable at 30 °C



New product

€	Glove Size	5 / XXS	6 / XS	7 / S	8 / M	9 / L	10 / XL
1/70	black	3230387	3230388	3230389	3230390	3230391	3230392
	white	3230393	3230394	3230395	3230396	3230397	3230398

Composition

Textile	51 % Nylon, 49 % polyurethane
---------	-------------------------------

Riding Gloves Dana

- lies pleasantly on the skin ensuring pleasant wearing comfort
- highly elastic and excellent grip for the ultimate in wearing comfort
- hook and loop fastener at the wrist
- breathable
- machine washable at 30 °C



€	Glove Size	6 / XS	7 / S	8 / M	9 / L	10 / XL
1/70	black	3211562	3211563	3211564	3211565	3211566

Composition

Textile	65 % Polyester, 35 % polyurethane
Palm of the hand	82 % Nylon, 18 % Elastane

Riding Gloves Gloria

- particularly soft and sturdy • lies pleasantly on the skin ensuring pleasant wearing comfort
- highly elastic and excellent grip for the ultimate in wearing comfort • elasticated insert in the ankle area for even more freedom of movement
- hook and loop fastener at the wrist • machine washable at 30 °C



Children's sizes:

€	Glove Size	S	M	L
1/100	black	3222912	3222913	3222914

Women's sizes:

€	Glove Size	6 / XS	7 / S	8 / M	9 / L	10 / XL
1/10/100	white	323825	323826	323827	323828	323829
	black	323830	323831	323832	323833	323834
	navy blue	323835	323836	323837	323838	323839



Composition	
Textile	93 % polyurethane, 6 % Polyester, 1 % Elastane

Riding Gloves Jersey

- perfect fit • inner hand with particularly good grip and non-slip properties • comfortable to wear made of jersey/cotton • incl. rein reinforcements • hook and loop fastener at the wrist • machine washable at 30 °C



€	Glove Size	6 / XS	7 / S	8 / M	9 / L	10 / XL
1/12/100	white	32656	32603	32604	32605	32657
	black	32658	32606	32607	32608	32659

Composition	
Textile	95 % Cotton, 5 % Elastane
Hook and Loop Fastener	50 % Nylon, 50 % polyurethane
Nubs	100 % Polyvinyl chloride

Riding Gloves SummerTech

- an airy summer riding glove with textile back and palm surface with excellent grip • elasticated, breathable textile material on the back of the hand ensures optimum ventilation • lightweight and embossed material with excellent grip properties on the palm surface ensure superb sensitivity on the reins • close-fitting glove with excellent fit • hook and loop fastener at the wrist • machine washable at 30 °C



€	Glove Size	6 / XS	7 / S	8 / M	9 / L	10 / XL
1/100	black	323840	323841	323842	323843	323844

Composition	
Back of the hand	60 % Polyester, 35 % polyurethane, 5 % Elastane
Palm of the hand	100 % polyurethane

Riding Gloves Lilli Starlight

- durable children's riding gloves made from faux leather
- highly elastic and excellent grip for the ultimate in wearing comfort
- elastic cuff band
- incl. rein reinforcements
- hook and loop fastener at the wrist
- machine washable at 30 °C



€	Glove Size	S	M	L
1/100	black / pink	3210553	3210554	3210555
	black / purple	3210556	3210557	3210558

Composition	
Back of the hand	98 % Nylon, 2 % Spandex
Palm of the hand	60 % Nylon, 40 % polyurethane

Riding Gloves MagicTouch

the glove for the touch screen generation

- covered silver fibres in the fingertips mean that the gloves no longer need to be removed to operate a touchscreen
- multi-stretch
- textured palm area for secure grip
- unisize
- with elastic waist
- machine washable at 30 °C



Ref. no.	Colour	€
323845	black	1/12/240

Composition	
Textile	85 % polyacrylic, 15 % Elastane
Nubs	100 % Polyvinyl chloride

Riding Gloves Magic Grippy

- multi-stretch
- textured palm area for secure grip
- unisize
- Nub composition: 100 % PVC
- machine washable at 30 °C

Ref. no.	Description	Colour	Glove Size	€
321598	Kids	coloured	One size fits all	1/12/240
321599	Kids	bordeaux	One size fits all	1/12/240
321600	Kids	black	One size fits all	1/12/240
321601	Kids	navy blue	One size fits all	1/12/240
321602	Kids	white	One size fits all	1/12/240
32597	adults	grey	One size fits all	1/12/240
32598	adults	coloured	One size fits all	1/12/240
32599	adults	bordeaux	One size fits all	1/12/240
32600	adults	black	One size fits all	1/12/240
32601	adults	navy blue	One size fits all	1/12/240
32602	adults	white	One size fits all	1/12/240
32609	adults	light blue	One size fits all	1/12/240

Composition	
Textile	85 % polyacrylic, 15 % Elastane
Nubs	100 % Polyvinyl chloride



Fleece Glove Xaina

- particularly soft and comfortable-to-wear gloves
- elastic material
- including reins reinforcement and printed hand surface
- machine washable at 30 °C

Children's sizes:

€	Glove Size	S	M	L
1/10/100	black	3222095	3222096	3222097

Women's sizes:

€	Glove Size	5 / XXS	6 / XS	7 / S	8 / M	9 / L	10 / XL
1/100	black	3221435	3221436	3221437	3221438	3221439	3221440

Composition

Textile	100 % Polyester
Anti-slip Print	100 % Silicon



Winter riding glove Mora

- durable, soft functional glove made from high-tech material
- highly elastic and excellent grip for the ultimate in wearing comfort
- with Thinsulate® middle layer and lightweight fleece lining
- incl. rein reinforcements
- hook and loop fastener at the wrist
- machine washable at 30 °C

€	Glove Size	6 / XS	7 / S	8 / M	9 / L	10 / XL
1/100	black	3210520	3210521	3210522	3210523	3210524

Composition

Back of the hand	51 % Nylon, 49 % polyurethane
Palm of the hand	51 % Nylon, 49 % polyurethane
Feed	35 % Polyester, 65 % Polyolefin
Anti-slip Print	100 % Silicon



Thinsulate
INSULATION

Winter riding glove Nerica

The high-quality winter riding gloves for men and women are equipped with a Thinsulate® mid-layer that provides excellent thermal insulation.

- warm and soft winter riding glove in a modern design
- high wearing comfort due to breathable soft-shell inserts on the back of the hand
- with insulating Thinsulate® mid-layer and soft fleece lining
- incl. rein reinforcements
- good grip thanks to hook-and-loop fastener at the wrist
- machine washable at 30 °C

€	Glove Size	5 / XXS	6 / XS	7 / S	8 / M	9 / L	10 / XL
1/50	black	3228153	3228154	3228155	3228156	3228157	3228158

Composition

Textile	85 % Polyamide, 15 % Elastane
Insulation	63 % Polypropylene, 37 % Polyester
Palm of the hand	55 % polyurethane, 45 % Polyamide
Feed	100 % Polyester



Thinsulate
INSULATION

Helmet Eclipse

- classic riding helmet in elegant matt black with glitter appliqué
- disc-system for one-handed multistage adjustment to the size of one's head
- integrated ERT system minimises rotational forces during a fall, and thus provides increased safety when riding
- exceptional ventilation system provides the optimum climate under the helmet
- removable lining for easy cleaning
- extra hard shell made of ABS
- 4-point fastening
- tested according to: EN1384:2023



Ref. no.	Colour	Head Circumference		€
3230156	black	52 - 56 cm	1/10	
3230157	black	56 - 58 cm	1/10	
3230158	black	58 - 61 cm	1/10	



Helmet Eclipse Polo

- elegant helmet in gloss look, with modern polo peak
- disc-system for one-handed multistage adjustment to the size of one's head
- integrated ERT system minimises rotational forces during a fall, and thus provides increased safety when riding
- exceptional ventilation system provides the optimum climate under the helmet
- removable lining for easy cleaning
- extra hard shell made of ABS
- 4-point fastening
- tested according to: EN1384:2023



Ref. no.	Colour	Head Circumference		€
3230159	black gloss	52 - 56 cm	1/10	
3230160	black gloss	56 - 58 cm	1/10	
3230161	black gloss	58 - 61 cm	1/10	



Helmet Elite

- elegant, classic riding helmet with outstanding fit
- soft, high-quality attaching straps finished with faux leather
- disc-system for one-handed multistage adjustment to the size of one's head
- exceptional ventilation system provides the optimum climate under the helmet
- softly padded internal lining can be removed for optimum cleaning
- extra hard shell made of ABS
- 4-point fastening
- tested according to: EN1384:2023



Available from: April 2025

Ref. no.	Colour	Head Circumference		€
3230544	black	53 - 55 cm	1/9	
3230162	black	56 - 58 cm	1/9	
3230163	black	59 - 61 cm	1/9	
3230545	black gloss	53 - 55 cm	1/9	
3230164	black gloss	56 - 58 cm	1/9	
3230165	black gloss	59 - 61 cm	1/9	
3230546	pink gold	53 - 55 cm	1/9	
3230166	pink gold	56 - 58 cm	1/9	
3230167	pink gold	59 - 61 cm	1/9	



Helmet Elite Polo

- Riding Helmet with Modern Polo Peak
- soft, high-quality attaching straps finished with faux leather
- disc-system for one-handed multistage adjustment to the size of one's head
- exceptional ventilation system provides the optimum climate under the helmet
- softly padded internal lining can be removed for optimum cleaning
- extra hard shell made of ABS
- 4-point fastening
- tested according to: EN1384:2023



Available from: April 2025

Ref. no.	Colour	Head Circumference		€
3230547	black	53 - 55 cm	1/9	
3230168	black	56 - 58 cm	1/9	
3230169	black	59 - 61 cm	1/9	
3230548	black gloss	53 - 55 cm	1/9	
3230170	black gloss	56 - 58 cm	1/9	
3230171	black gloss	59 - 61 cm	1/9	
3230549	pink gold	53 - 55 cm	1/9	
3230172	pink gold	56 - 58 cm	1/9	
3230173	pink gold	59 - 61 cm	1/9	



Helmet Nerron

Trendy, sporting training and tournament helmet!

- aerodynamic profile in sophisticated black
- disc-system for one-handed multistage adjustment to the size of one's head
- the height of the head ring on the back of the head can also be adjusted via a click system
- extra-hard helmet shell
- with flexible visor
- exceptional ventilation system provides the optimum climate under the helmet
- ventilation slots with integrated insect screens
- 4-point fastening with high-quality closures
- removable lining for easy cleaning
- tested according to: EN1384:2023

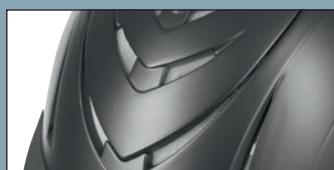

Large air vents ensure an optimum climate



Disc system for single-handed adjustment to give the perfect fit!

Ref. no.	Colour	Head Circumference		€
32298	black	51 - 54 cm	1/10	
32299	black	55 - 59 cm	1/10	



Helmet eXite

High-quality riding helmet with in-mould construction featuring excellent fit and six ventilation openings for an excellent climate under the helmet. The Riding Helmet eXite impresses with its low weight and streamlined design.

- ultra-elastic head ring with disc system ensures customised and infinite adjustment to the rider's head
- helmet visor made from flexible plastic
- soft padded inner lining cap for easy cleaning in the washing machine
- exceptional ventilation system provides the optimum climate under the helmet
- fast-click closing allows fine adjustment to the chin and ensures quick opening with just one hand
- 4-point fastening
- tested according to: EN1384:2023



Ref. no.	Colour	Head Circumference		€
3231350	black	52 - 56 cm	1/12	
3231351	black	57 - 60 cm	1/12	



Helmet Beauty 2.0

Youthful, trendy riding helmet in modern colourways with a floral design

- disc-system for one-handed multistage adjustment to the size of one's head
- shock-proof shell
- well-engineered ventilation system for warm weather comfort
- slim profile helmet
- 4-point fastening
- tested according to: EN1384:2023



New product NEW





Ref. no.	Colour	Head Circumference		€
3230152	grey	48 - 51 cm	1/10	
3230153	grey	52 - 54 cm	1/10	
3230154	black	48 - 51 cm	1/10	
3230155	black	52 - 54 cm	1/10	

Helmet Case

- attractive case for safe storage and for easier transportation of riding helmets
- one-size thanks to the built-in elasticated net, which keeps the helmet securely in place
- all-round zip fastener for easy helmet removal
- Exterior covering from high-quality microfibre
- incl. carrying handle with non-slip grip



Ref. no.	Colour			€
321245	black	1/6	48	

Safety Vest for Riders ProtectoFlex light

The panel-like protective cushions guarantee maximum protection upon impact on the one hand, and a perfect fit on the other.

- the special arrangement of the protective cushions ensures complete freedom of movement with the highest safety standards
- the newly developed features for easy adjustment not only enhance safety but also increase the vest's visual appeal
- the cut, material and functionality ensure the highest standards amongst the protective vests available on the market



Zip for easy putting-on and taking-off

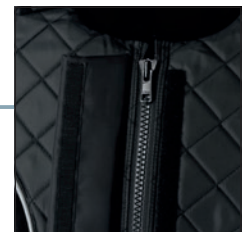

Honeycomb design for optimum movement



double hook and loop safety closure for individual fit



tested according to EN 13158, Level 3,
BETA certified

Ref. no.	Colour	Description	Size	Chest circumference A	Waist circumference B	Waist-shoulder-waist D		€
322246	black	Children	XS	68 - 72 cm	64 - 70 cm	67 - 72 cm	1/10	
322247	black	Children	S	72 - 77 cm	69 - 74 cm	72 - 77 cm	1/10	
322248	black	Children	M	77 - 81 cm	74 - 77 cm	78 - 84 cm	1/10	
322249	black	Children	L	81 - 84 cm	75 - 80 cm	84 - 88 cm	1/10	
322276	black	adults	XS	83 - 87 cm	79 - 82 cm	83 - 90 cm	1/10	
322277	black	adults	S	88 - 93 cm	83 - 90 cm	86 - 93 cm	1/10	
322278	black	adults	M	95 - 100 cm	90 - 98 cm	89 - 95 cm	1/10	
322279	black	adults	L	98 - 104 cm	96 - 102 cm	92 - 97 cm	1/10	

Composition

Outer material	100 % Nylon
Feed	100 % Polyester
Shock-absorbing material	100 % PVC

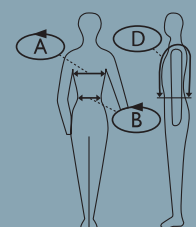

Airbag Vest Manege

- easy-to-wear Airbag Vest
- available in six different sizes
- to be worn over regular clothing or even other safety vests and/or back protection products
- when the safety mechanism is triggered, the vest inflates with air within 0.3 seconds
- the vest forms an airbag around the upper body, surrounding the chest and hips, and, above all, also the back and spine
- used Co2 cartridges can be replaced easily and the jacket is again immediately ready for use

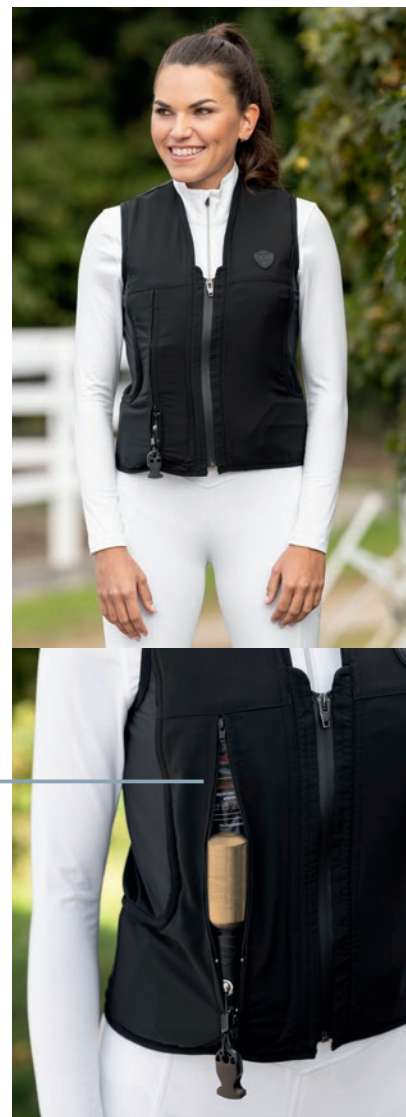

New product 

mesh channel on the back for good ventilation

the shape and low weight allow the waistcoat to be worn like an item of clothing

compact integrated CO2 technology that doesn't cause problems while wearing

side mesh inserts for easy adjustment

Quick closure for easy release from the saddle

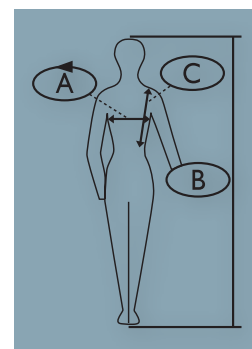



according to PSA 2016/425 (Alienor Certification (2754) - NF S72-800:2022)

Composition

Outer material Nylon



Ref. no.	Description	Size	Body size B	Chest circumference A	Back length C		€
3230174	adults	XXS	125 - 140 cm	70 cm	26 cm	1	
3230175	adults	XS	140 - 155 cm	75 cm	28 cm	1	
3230176	adults	S	155 - 165 cm	80 cm	30 cm	1	
3230177	adults	M	165 - 170 cm	85 cm	33 cm	1	
3230178	adults	L	170 - 180 cm	90 cm	35 cm	1	
3230179	adults	XL	180 - 195 cm	95 cm	37 cm	1	

Ref. no.	Description	Length	suitable for	Weight		€
3230180	CO2 Cartridge for Airbag Vest		3230174, 3230175	33 g	1/100	
3234348	Fastening strap for airbag waistcoat	63 cm			1	
3234349	Fastening strap for airbag waistcoat	72 cm			1	
3234350	Saddle attachment to connector strap				1	
3230181	CO2 Cartridge for Airbag Vest		3230176, 3230177	38 g	1/100	
3230182	CO2 Cartridge for Airbag Vest		3230178, 3230179	45 g	1/100	

Back Protection Vest BackPro3

The multi-layer safety vest is made of particularly light, flexible material so that it offers the wearer optimum freedom of movement with maximum safety and fits under any jacket.

- lightweight vest-shaped back protector for children and adults
- Back protection padding made from multi-layer high density foam which adapts perfectly to the shape of the body
- fits under any jacket thanks to the low material thickness
- elastic and breathable for maximum freedom of movement and wearing comfort
- with webbing for additional fixation



Strong impact-absorbing foam

High-tech material composition adapts perfectly to body shape

breathable front section

Enhanced coccyx protection



EN 1621, Level 2: Motorcycle rider protective clothing against mechanical stress

Ref. no.	Colour	Description	Size	Back length C		€
3228159	black	Children	M	29 - 34 cm	1/10	
3228160	black	Children	L	34 - 38 cm	1/10	
3228161	black	adults	XS	38 - 41 cm	1/10	
3228162	black	adults	S	41 - 45 cm	1/10	
3228163	black	adults	M	45 - 48 cm	1/10	
3228164	black	adults	L	48 - 52 cm	1/10	
3228165	black	adults	XL	52 - 57 cm	1/10	

Composition

Outer material	100 % Nylon
Feed	100 % Polyester
Shock-absorbing material	100 % PVC

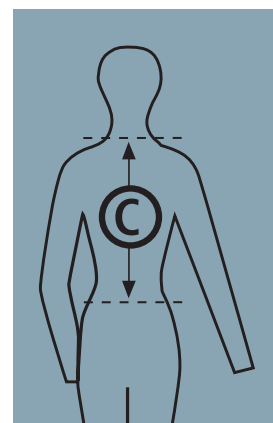

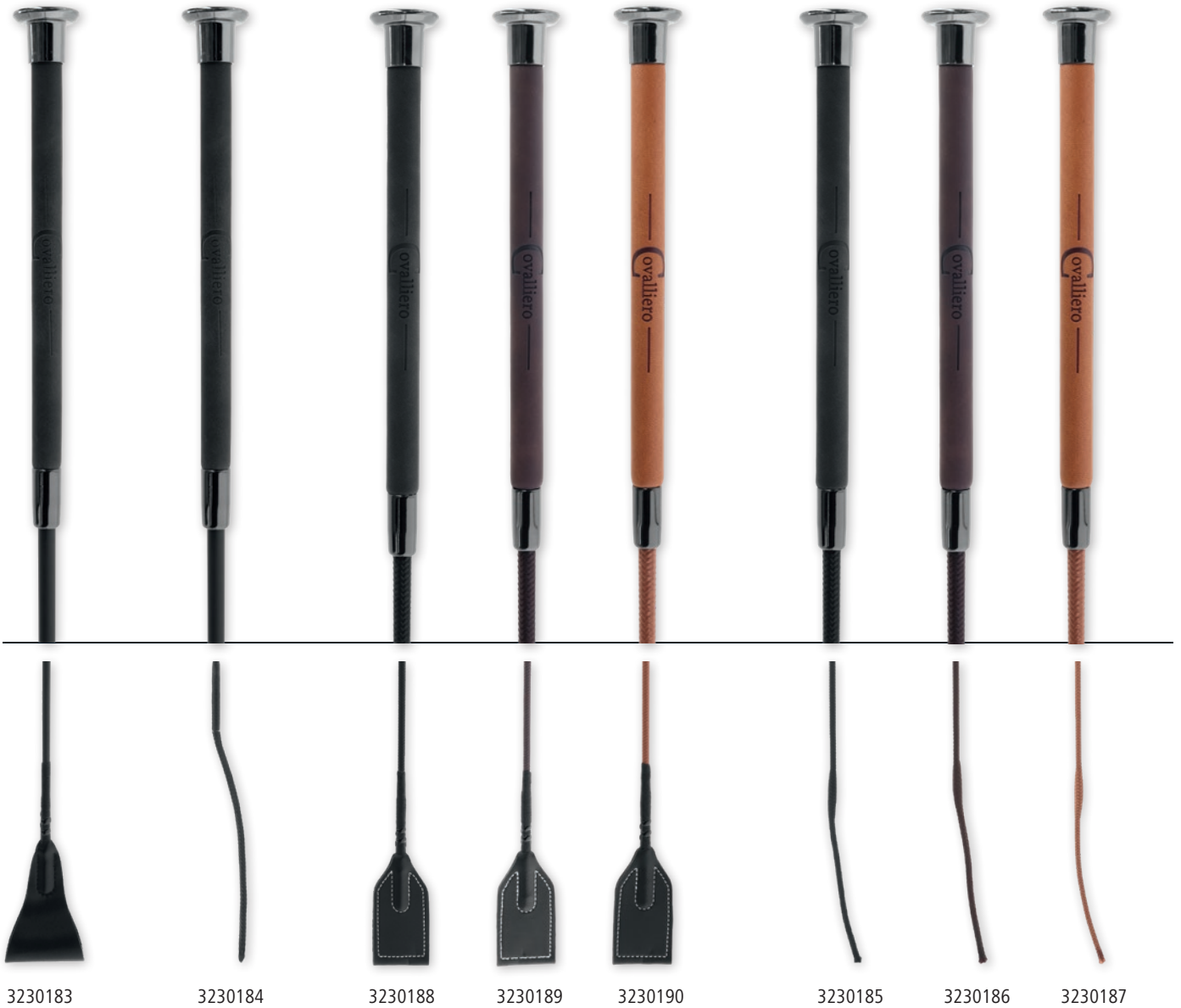

3230183

3230184

3230188

3230189

3230190

3230185

3230186

3230187

Jumping whip Carbon

• faux leather handle with elegant appliqué logo • with carbon shaft

New product **NEW**

Ref. no.	Colour	Length		€
3230183	black	65 cm	1/100	

Dressage crop Carbon

• faux leather handle with elegant appliqué logo • with carbon shaft

New product **NEW**

Ref. no.	Colour	Length		€
3230184	black	110 cm	1/100	

Jumping whip

• faux leather handle with elegant appliqué logo • Material: fibreglass, covered

New product **NEW**

Ref. no.	Colour	Length		€
3230188	black	65 cm	1/100	
3230189	brown	65 cm	1/100	
3230190	cognac	65 cm	1/100	

Dressage crop

• faux leather handle with elegant appliqué logo • Material: fibreglass, covered

New product **NEW**

Ref. no.	Colour	Length		€
3230185	black	110 cm	1/100	
3230186	brown	110 cm	1/100	
3230187	cognac	110 cm	1/100	



321481

321482

321484

321488 / 3297625

32367

32362

32366

Dressage crop

- Covered fibreglass shaft
- handle made from soft synthetic leather

Ref. no.	Colour	Length		€
321481	navy blue	110 cm	1/125	
321482	bordeaux	110 cm	1/125	
321484	brown	110 cm	1/125	
321488	black	110 cm	1/125	
3297625	black	120 cm	1/125	

Dressage crop

- napped grip
- Material: fibreglass, covered

Ref. no.	Colour	Length		€
32362	black	100 cm	1/200	

Dressage crop

- PVC-coated grip with wrist loop
- Material: fibreglass, covered

Ref. no.	Colour	Length		€
32367	black	100 cm	1/200	

Dressage crop

- Material: fibreglass, covered

Ref. no.	Colour	Length		€
32366	black	120 cm	1/125	



325995

325996

320101, 320102

320100, 320105

320096, 320097

Dressage crop

- with anti-slip handle
- with gold or silver-coloured appliqués
- Material: fibreglass, covered

Ref. no.	Colour	Length		€
325995	gold	110 cm	1/5/100	
325996	silver	110 cm	1/5/100	

Dressage / Riding Crop

- with glitter appliqué
- handle made from soft synthetic leather
- Material: fibreglass, covered

Ref. no.	Colour	Length		€
320100	black	110 cm	1/125	
320105	black	120 cm	1/125	

Dressage Crop with Keeper

- synthetic leather handle with glitter appliqué
- Material: fibreglass, covered

Ref. no.	Colour	Length		€
320101	black	110 cm	1/125	
320102	black	120 cm	1/125	

Dressage crop

- handle made from soft synthetic leather
- Material: fibreglass, covered

Ref. no.	Colour	Length		€
320096	cognac	110 cm	1/125	
320097	cognac	120 cm	1/125	



32363

321486

325997

325998

321485

321485

321485

Whip

- grip with wrist loop
- Material: fibreglass, covered

Ref. no.	Colour	Length		€
32363	black	90 cm	1/100	

Jumping Whip with Flap

- with anti-slip handle
- with gold or silver-coloured appliqué
- Material: fibreglass, covered

Ref. no.	Colour	Length		€
325997	gold	65 cm	1/5/100	
325998	silver	65 cm	1/5/100	

Whip

- horse-head-shaped PVC grip

Ref. no.	Colour	Length		€
321486	black	90 cm	1/10/200	

Jumping Whip with Hand Strap

- colour-sorted in red, black and green

Ref. no.	Colour	Length		€
321485	assorted colours	65 cm	1/10/200	

Jumping Whip with Flap

- synthetic leather handle with glitter appliqué
- Material: fibreglass, covered

Ref. no.	Colour	Length		€
3226282	rose	65 cm	1/125	
320103	silver	65 cm	1/125	

Jumping Whip with Flap

- handle made from soft synthetic leather
- Material: fibreglass, covered

Ref. no.	Colour	Length		€
3226283	black	65 cm	1/125	
3226284	navy	65 cm	1/125	
320106	cognac	65 cm	1/125	

Jumping Whip with Flap

- with silver-glittered, flower-shaped flap
- grip with wrist loop
- Material: fibreglass, covered

Ref. no.	Colour	Length		€
320107	pink / silver	65 cm	1/125	



Jumping Whip with Flap

- PVC grip
- Material: fibreglass, covered

Ref. no.	Colour	Length		€
32364	black	65 cm	1/10/200	

Whip Holder

- plastic holder for 11 whips
- easy installation with 4 pre-drilled holes

Ref. no.	Colour	Width	Height	Depth	Material			€
32358	black	31 cm	9 cm	4 cm	Plastic	1/100	1.000	



Saddle Set

The starter kit at a great price

- Please note that for this low-priced offer we cannot consider special wishes in colour or length.

Set consisting of: 1 x saddle, 1 x saddle cloth, 2 x stirrups, 1 x stirrup strap, 1 x saddle strap



Ref. no.	Description	Colour	Saddle size	Tree width	Length of the girth		€
32196	Pony	black	16.0 inches	29,5 cm	95 cm	1	
32197	General purpose	black	17.5 inches	30,5 cm	125 cm	1	
32285	Hafingers	black	17.5 inches	34,5 cm	125 cm	1	
32198	Hafingers	brown	17.5 inches	34,5 cm	125 cm	1	

Saddle Set Economy Pony

- high-quality saddle made from synthetic material
- anti-slip seat for perfect support in the saddle
- saddle cushion can be adjusted to fit using hook and loop fastener
- knee rolls can be removed and adjusted using a hook and loop fastener for the ideal sitting position
- handle on pommel, ideal for beginners



Set consisting of: 1 x saddle, 1 x cotton saddle strap, 2 x stirrups, 1 x stirrup strap



Ref. no.	Colour	Saddle size	Tree width	Length of the girth		€
325415	black	15.0 inches	34,5 cm	110 cm	1	

Riding pad AiRide

The anatomically shaped, lightweight riding pad is an ideal saddle alternative. The high-quality foam filling for optimal pressure distribution promises comfort for the horse and a pleasantly natural riding feeling with very good contact with the horse.

- optimal pressure distribution due to the particularly elastic foam filling
- perfect grip thanks to synthetic leather seat surface
- Easy to clean
- light weight for increased horse comfort
- excellent direct contact with the horse for a natural riding experience
- no slipping thanks to bobbles on the underside
- tearproof strips for secure fastening of the abdominal belt



Ref. no.	Colour	Length		€
3228166	black	50 cm	1/8	

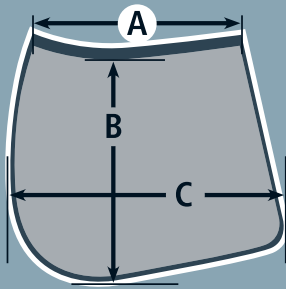

Saddle cloth dimensions:

- A = width
- B = maximum height
- C = maximum width



Underside of material is quick-drying and breathable



Saddle Pad Salvina

- quick-drying and breathable material bottom surface
- high-quality foam and polyester filling for optimum pressure balance
- durable upper material
- mesh insert for greater breathability
- anatomically shaped
- saddle and belt loops with hook and loop fastener
- attractive stitching with decorative piping
- machine washable at 30 °C

Versatility



Dressage



Ref. no.	Saddle pad shape	Colour	Width A	Height B	max. width C		€
3226327	General purpose Pony	marine	57 cm	49 cm	62 cm	1/15	
3226328	General purpose	marine	61 cm	54 cm	67 cm	1/15	
3226329	Dressage	marine	62 cm	54 cm	68 cm	1/15	
3226330	General purpose Pony	graphite	57 cm	49 cm	62 cm	1/15	
3226331	General purpose	graphite	61 cm	54 cm	67 cm	1/15	
3226332	Dressage	graphite	62 cm	54 cm	68 cm	1/15	
3226333	General purpose Pony	black	57 cm	49 cm	62 cm	1/15	
3226334	General purpose	black	61 cm	54 cm	67 cm	1/15	
3226335	Dressage	black	62 cm	54 cm	68 cm	1/15	
3210474	General purpose Pony	iceblue	57 cm	49 cm	62 cm	1/15	
3210476	General purpose	iceblue	61 cm	54 cm	67 cm	1/15	
3210478	Dressage	iceblue	62 cm	54 cm	68 cm	1/15	
3211660	General purpose Pony	bordeaux	57 cm	49 cm	62 cm	1/15	
3211567	General purpose	bordeaux	61 cm	54 cm	67 cm	1/15	
3211568	Dressage	bordeaux	62 cm	54 cm	68 cm	1/15	
3222103	General purpose Pony	green forest	57 cm	49 cm	62 cm	1/15	
3222104	General purpose	green forest	61 cm	54 cm	67 cm	1/15	
3222105	Dressage	green forest	62 cm	54 cm	68 cm	1/15	

Saddle Pad Empara

- with subtle glitter appliqués
- anatomically shaped
- high-quality foam and polyester filling for optimum pressure balance
- quick-drying and breathable material bottom surface
- Anti-slip padding at the withers
- Belt loops with hook-and-loop fastener
- machine washable at 30 °C



Versatility



Dressage



Suitable for: Fly Mask Empara 3297773 - 3297775 and Fleece Bandage Empara 3297776 - 3297778

Ref. no.	Saddle pad shape	Colour	Width A	Height B	max. width C		€
3297714	General purpose	black	58 cm	53 cm	68 cm	1/15	
3297715	Dressage	black	63 cm	53 cm	68 cm	1/15	
3297716	General purpose	white	58 cm	53 cm	68 cm	1/15	
3297717	Dressage	white	63 cm	53 cm	68 cm	1/15	
3297718	General purpose	navy	58 cm	53 cm	68 cm	1/15	
3297719	Dressage	navy	63 cm	53 cm	68 cm	1/15	

Saddle Pad Linea

- quick-drying and breathable material underside in waffle look
- high-quality foam and polyester filling for optimum pressure balance
- hard-wearing, dimensionally stable upper material
- integrated mesh channel along the spine
- anatomically shaped
- machine washable at 30 °C

New product

NEW

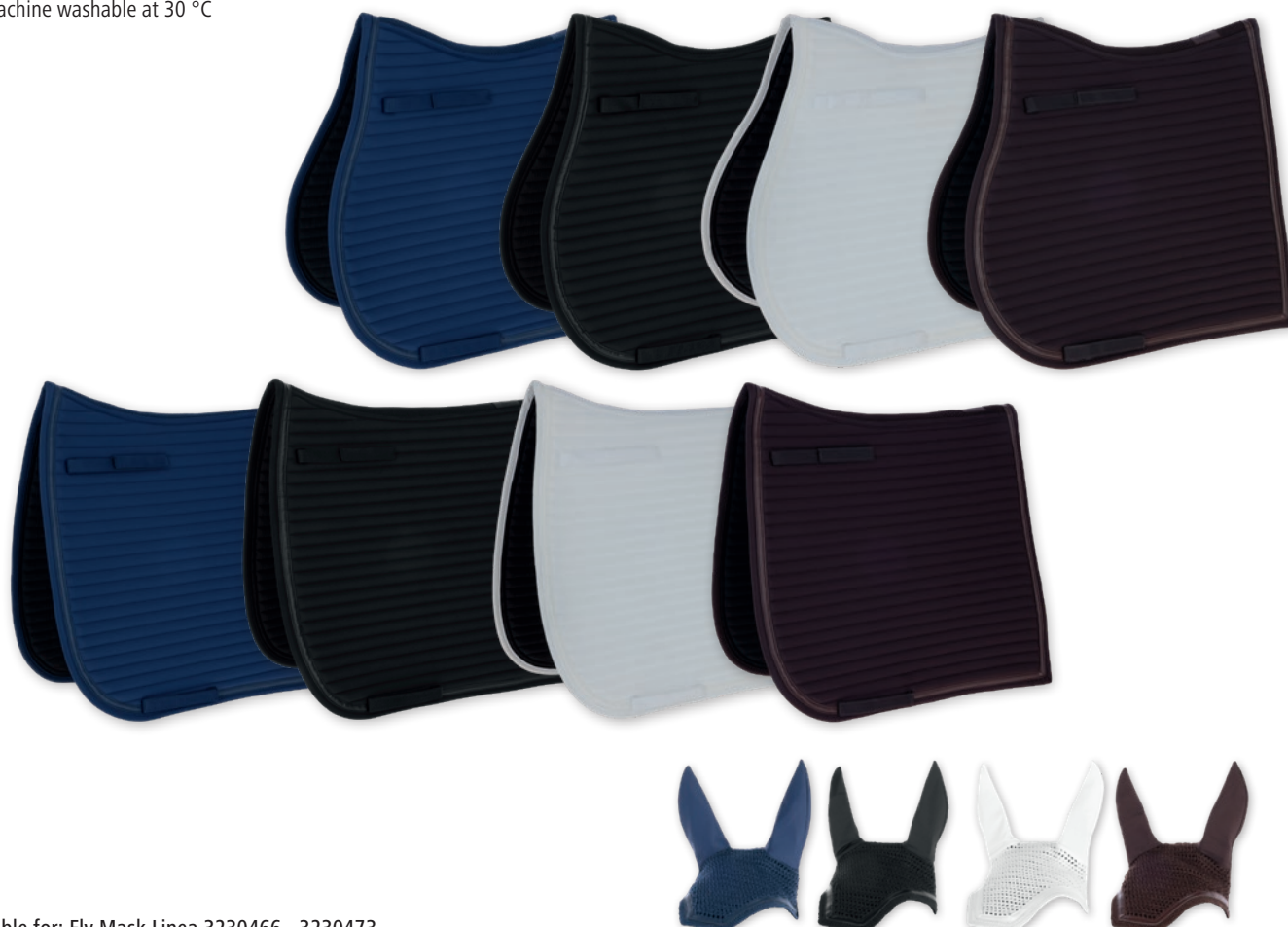

suitable for: Fly Mask Linea 3230466 - 3230473

Ref. no.	Saddle pad shape	Colour	Width A	Height B	max. width C		€
3230399	General purpose	dark navy	58 cm	49 cm	68 cm	1/10	
3230400	Dressage	dark navy	63 cm	55 cm	68 cm	1/10	
3230401	General purpose	black	58 cm	49 cm	68 cm	1/10	
3230402	Dressage	black	63 cm	55 cm	68 cm	1/10	
3230403	General purpose	white	58 cm	49 cm	68 cm	1/10	
3230404	Dressage	white	63 cm	55 cm	68 cm	1/10	
3230405	General purpose	brown	58 cm	49 cm	68 cm	1/10	
3230406	Dressage	brown	63 cm	55 cm	68 cm	1/10	

Trail Saddle Cloth Laguna

- specially designed for horse rides, hunts, distance riding or trail rides
- large side pocket with hook and loop fastener, both sides
- quick-drying and breathable material bottom surface
- high-quality foam and polyester filling for optimum pressure balance
- durable upper material
- saddle and belt loops with hook and loop fastener
- machine washable at 30 °C

waterproof pockets



Ref. no.	Saddle pad shape	Colour	Width A	Height B	max. width C		€
328647	General purpose	black	58 cm	52 cm	68 cm	1/15	

Saddle Cushions and Saddle Straps

Corrector Saddle Cushion Faux Fur AntiSlip

The special comfort for your horse

- exchangeable felt inlays for optimum saddle adjustment (thickness per piece approx. 0.4 cm)
- 12 felt inlays (6 pieces for front and 6 pieces for rear)
- cotton top layer with anti-slip bobbles for excellent grip underneath the saddle
- with faux fur front and back



Ref. no.	Colour	Size		€
3297730	black	Pony	1/15	
3297729	black	Full	1/15	

Corrector Saddle Cushion Faux Fur

The special comfort for your horse

- with faux fur front and back
- easy-care cotton quilted cover
- with girth straps



Ref. no.	Colour	Size		€
3297727	white	Pony	1/20	
3297728	white	Full	1/20	
3297731	black	Pony	1/20	
3297732	black	Full	1/20	

Faux Fur Set for Halter

- for avoiding pressure and rubbing
- with hook and loop fastener

Set includes: 1 x nose band, approx. 3.5 x 25 cm, 1 x neck band, approx. 3.5 x 32 cm, 2 x cheek bands, approx. 3.5 x 15 cm



Ref. no.		€
3297733	1/100	

Saddle Strap Protector

- for sensitive horses • Faux fur • with hook and loop fastener • washable at 30 °C



Super soft fabric!

Ref. no.	Colour	Length	Width		€
3297786	nature	80 cm	14 cm	1/24	

Saddle Cushions and Saddle Straps

Saddle Strap Protector

- for sensitive horses
- Faux fur
- washable at 30 °C



Super soft fabric!

Ref. no.	Colour	Length	Width		€
323910	black	95 cm	10 cm	1/50	

Protective Saddle Cover

- protects your saddle from dust and excess moisture
- for English saddles
- made from cotton



Ref. no.	Colour	Size		€
321395	black	Pony	1/50	
32291	black	Full	1/50	

Saddle Underlay AntiSlip

- lightweight and functional, the anti-slip saddle pad made from EVA
- recommended for horses with a difficult or slippery saddle area
- gives the saddle and rider a better grip and more relaxed seating position
- lots of small ventilation holes prevent the horse from sweating too much
- laid directly on the horse's back under the saddle cloth
- machine washable at 30 °C

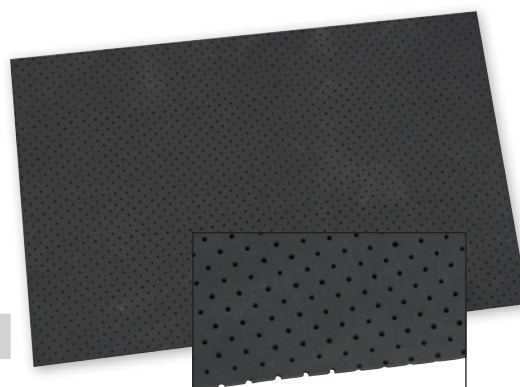

Ref. no.	Colour	Length	Width	Height		€
321357	black	60 cm	45 cm	0,6 cm	1/30	

Saddle Strap Extender

- sturdy buckles
- extends your girth by up to 27 cm
- Material: Leather



Ref. no.	Colour		€
32436/1	black	1/120	
32437/1	brown	1/120	



genuine leather



Holding Leather Strap

- sewn round
- with buckle
- Material: Leather



Ref. no.	Colour	Length		€
32645	brown	30 cm	1/300	
32223	black	30 cm	1/25/300	

genuine leather



Saddle Cushions and Saddle Straps

faux fur short harness

- high-quality anatomical belt with faux fur • optimal protection for abrasion and pressure points • with D-ring for easy attachment of a breastplate or auxiliary reins
- with elastic straps • with roller buckles for easy adjustment

Ref. no.	Colour	Length		€
3224605	black	50 cm	1/25	
3224606	black	55 cm	1/25	
3224607	black	60 cm	1/25	
3224608	black	65 cm	1/25	
3224609	black	70 cm	1/25	
3224610	black	75 cm	1/25	
3230191	black	80 cm	1/25	NEW
3230192	black	85 cm	1/25	NEW



Saddle strap faux fur

- high-quality anatomical long belt with faux fur • optimal protection for abrasion and pressure points • with three D-rings for easy attachment of the breastplate or auxiliary reins • with elastic straps • with roller buckles for easy adjustment

Ref. no.	Colour	Length		€
3226337	black	110 cm	1/12	
3226338	black	115 cm	1/12	
3226339	black	120 cm	1/12	
3226340	black	125 cm	1/12	
3226341	black	130 cm	1/12	
3226342	black	135 cm	1/12	
3226343	black	140 cm	1/12	



Girth

- Dressage girth made from synthetic rubber with roller buckles • anatomically curved for the horse's ease of movement • also suitable for tree-less Freedom saddle • elastic ends on both sides • with roller buckles for easy adjustment

Ref. no.	Colour	Length		€
32442	black	45 cm	1/40	
32443	black	50 cm	1/40	
3211575	black	55 cm	1/40	
32444	black	60 cm	1/40	
3211576	black	65 cm	1/40	
32445	black	70 cm	1/40	
3211577	black	75 cm	1/40	
3211578	black	80 cm	1/40	
3211579	black	85 cm	1/40	



Short belt straight

- high-quality saddle strap made from synthetic rubber
- with a centre D-ring for easy attachment of breastplate or auxiliary reins
- with roller buckles for easy adjustment
- easy to clean

Ref. no.	Colour	Length		€
3230407	black	45 cm	1/10	
3230408	black	50 cm	1/10	
3230409	black	55 cm	1/10	
3230410	black	60 cm	1/10	
3230411	black	65 cm	1/10	
3230412	black	70 cm	1/10	
3230413	black	75 cm	1/10	
3230414	black	80 cm	1/10	



Curved Saddle Strap

- soft, friction-free and easy to care for PU
- the entire strap is reinforced, making it extremely durable and tear-resistant
- with roller buckles for easy adjustment
- elastic ends on one side
- washable

Ref. no.	Colour	Length		€
321055	black	110 cm	1/25	
3222113	black	115 cm	1/25	
321056	black	120 cm	1/25	
3222114	black	125 cm	1/25	
321057	black	130 cm	1/25	
3222115	black	135 cm	1/25	
321058	black	140 cm	1/25	



Saddle strap

- padded
- Cotton material with reinforcement
- with roller buckles for easy adjustment

Ref. no.	Colour	Length		€
32432	black	110 cm	1/40	
32433	black	120 cm	1/40	
32435	black	140 cm	1/40	
32431	black	100 cm	1/40	
32434	black	130 cm	1/40	



Saddle Strap with Memory Foam

- shell made from synthetic rubber for optimum durability and longevity
- fitted with soft memory foam that adapts well to the contours and hugs the belly perfectly
- optimum freedom of movement thanks to curved shape
- with a centre D-ring for easy attachment of breastplate or auxiliary reins
- fitted with elastic straps on one side
- with roller buckles for easy adjustment
- strap side approx. 8.5-10.5 cm
- easy to clean
- washable

Ref. no.	Colour	Length		€
3211580	black	110 cm	1/40	
3222110	black	115 cm	1/40	
3211581	black	120 cm	1/40	
3222111	black	125 cm	1/40	
3211582	black	130 cm	1/40	
3222112	black	135 cm	1/40	
3211583	black	140 cm	1/40	



Stirrups, Straps and Bits

Stirrups Secure

- with folding side bar that quickly releases the rider's foot in situations such as a fall
- optimised foot position and ergonomic design for more comfort and less fatigue even on long rides
- non-slip surface provides additional grip and safety
- made from lightweight aluminium with steel reinforcement in the area of the foot rest
- quick and uncomplicated attachment to any saddle
- in pairs



Ref. no.	Colour	Tread width		€
3230415	silver	12 cm	1/8	
3230416	black	12 cm	1/8	

Stirrups

- open sole
- with rubber insert
- Material: stainless steel
- in pairs



Ref. no.	Tread width		€
32353	10 cm	1/20	
32630	12 cm	1/20	

Stirrups without Inlay for Children

- Roughened tread
- for the first riding attempts in a pony saddle
- Material: galvanised metal
- in pairs



Ref. no.	Tread width		€
32634/1	9 cm	1/50	

Stirrup Inlay angled

- facilitates correct foot position
- in pairs

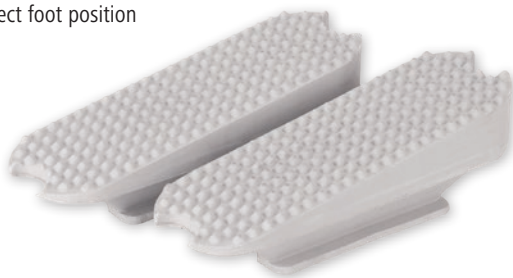

Ref. no.	Colour	Length		€
32638/1	white	12 cm	1	

Stirrup Insert

- in pairs

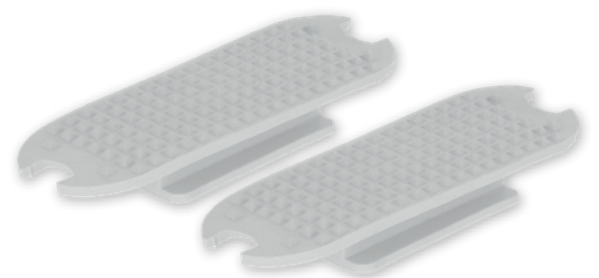

Ref. no.	Colour	Length		€
32637/1	white	12 cm	1	

Stirrup Straps Leather

- with buckle
- Material: Leather
- in pairs

Ref. no.	Colour	Length	Width	MOQ	Pieces / unit		€
32639	black	130 cm	25 mm	1 pack	2 / pack	1/50	
32347	black	145 cm	27 mm	1 pack	2 / pack	1/50	
323471	brown	145 cm	27 mm	1 pack	2 / pack	1/50	



genuine leather



Water Snaffle, hollow

- stainless



Ref. no.	Length	Thickness	MOQ	Pieces / unit		€
321731/1	10,5 cm	18 mm	1 blister pack	1 / blister pack	1	
32173/1	11,5 cm	18 mm	1 blister pack	1 / blister pack	1	
32174/1	12,5 cm	18 mm	1 blister pack	1 / blister pack	1	
32175/1	13,5 cm	18 mm	1 blister pack	1 / blister pack	1	
32176/1	14,5 cm	18 mm	1 blister pack	1 / blister pack	1	

Water Snaffle, French link

- stainless



Ref. no.	Length	Thickness	MOQ	Pieces / unit		€
321732/1	12,5 cm	18 mm	1 blister pack	1 / blister pack	1	
321733/1	13,5 cm	18 mm	1 blister pack	1 / blister pack	1	
321729/1	14,5 cm	18 mm	1 blister pack	1 / blister pack	1	

Eggbutt

- stainless



Ref. no.	Length	Thickness	MOQ	Pieces / unit		€			
321734/1	11,5 cm	18 mm	1 blister pack	1 / blister pack	1				
321735/1	12,5 cm	18 mm	1 blister pack	1 / blister pack	1				
32177/1	13,5 cm	18 mm </tr <tr> <td>321730/1</td> <td>14,5 cm</td> <td>18 mm</td> <td>1 blister pack</td> <td>1 / blister pack</td> <td>1</td> <td></td> </tr>	321730/1	14,5 cm	18 mm	1 blister pack	1 / blister pack	1	
321730/1	14,5 cm	18 mm	1 blister pack	1 / blister pack	1				

Bit Guards

- in pairs
- to protect the mouth corners

Ref. no.	Colour	Ø	MOQ	Pieces / unit		€
321727/2	black	7 cm	1 blister pack	2 / blister pack	1	
321728/2	black	9 cm	1 blister pack	2 / blister pack	1	

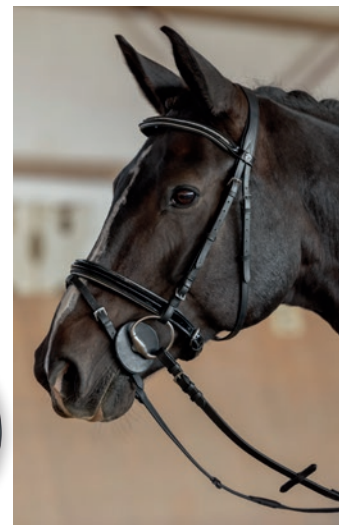

Bite protection tape

Self-adhesive, well-adhering bit bandage that reliably protects the horse's mouth from friction.

- soft, self-adhesive foam tape for winding around the horse bit, especially the bit edges
- offers ideal protection for your horse in the event of chafing or other problems
- easy to put on
- adapts flexibly to the horse's mouth without slipping
- contains natural latex

- Please change after each use.

Contains natural latex, may cause allergic reactions.

Ref. no.	Colour	Length	Width		€
3229064	beige	5 m	6 cm	1/50	



Sheet-metal punch

- high-quality sheet-metal punch with six punches • punches leather without force, but also cardboard, rubber or other materials • ideal power transmission with comfort handle with one-side ABS reinforcement • Hole size is adjustable in steps of 0.5 mm from 2.0 mm to 4.5 mm diameter



Ref. no.	Material		€
2995	metal, varnished	1/12/48	

Snaffle Clincher

- english combined halter • anatomically formed neck piece • soft padding with chin pad • curved brow strap with clinchers • incl. web bridle reins
- with rust-free fittings • without bit • Material: Leather

New product

NEW



genuine leather



Ref. no.	Colour	Size		€
3230193	black	Pony	1/10	
3230194	black	Cob	1/10	
3230195	black	Full	1/10	
3230196	brown	Pony	1/10	
3230197	brown	Cob	1/10	
3230198	brown	Full	1/10	

Brow Strap, Straight Clincher

- straight clincher brow strap as substitute for the clincher bridle which is equipped with curved brow strap • with rust-free fittings
- Material: Leather



Ref. no.	Colour	Size		€
3230208	black	Pony	1/100	
3230209	black	Cob	1/100	
3230210	black	Full	1/100	
3230211	brown	Pony	1/100	
3230212	brown	Cob	1/100	
3230213	brown	Full	1/100	

New product

NEW

Bridle, Swedish

- Swedish halter • anatomically formed neck piece • soft padding with chin pad • curved brow strap with dark rhinestones • incl. web bridle reins • with rust-free fittings • without bit • Material: Leather



New product 



Ref. no.	Colour	Size		€
3230199	black	Pony	1/10	
3230200	black	Cob	1/10	
3230201	black	Full	1/10	

genuine leather



Halter

- Halter in Gloss Finish, Perfect for use with Swedish Bridle
- soft padding • with rust-free fittings • Material: Leather

New product 



	€	Halter size	Pony	Cob	Full
1/25		black gloss	3230205	3230206	3230207

genuine leather



Snaffle Anatomic

- specially adapted to the horse's anatomy • soft padding and recess on the neck • simple, curved leather brow strap • incl. web bridle reins • with rust-free fittings • without bit



New product 



Ref. no.	Colour	Size		€
3230202	black	Pony	1/10	
3230203	black	Cob	1/10	
3230204	black	Full	1/10	

genuine leather



Snaffle Cancun

- Mexican Halter
- soft faux fur on the intersection for a high level of comfort
- contrasting seams
- incl. web bridle reins
- Material: Leather
- without bit



Ref. no.	Colour	Size		€
3297734	black	Pony	1/20	
3297735	black	Cob	1/20	
3297736	black	Full	1/20	

genuine leather



Snaffle Classic

- pretty snaffle bridle in a classic style made from high-quality leather
- attractive decorative seaming in white for an elegant look
- shoulder, nose and neck straps with soft padding layer
- includes web reins
- without bit



Ref. no.	Colour	Size		€
326137	black	Pony	1/25	
326138	black	Cob	1/25	
326139	black	Full	1/25	
324911	brown	Pony	1/25	
324912	brown	Cob	1/25	
324913	brown	Full	1/25	

genuine leather



Snaffle Standard

- english combined riding halter with flash strap
- hand-stitched
- Padded nose and headband
- good standard quality
- incl. web bridle reins
- Material: Leather
- adjustable
- without bit



Ref. no.	Colour	Size		€
321713	black	Shetty	1/30	
32170	black	Pony	1/30	
32171	black	Cob	1/25	
32172	black	Full	1/25	
321714	brown	Shetty	1/30	
321742	brown	Pony	1/30	
321743	brown	Cob	1/25	
321744	brown	Full	1/25	

genuine leather



Bridle Coldblood

- very sturdy bridle for heavy horses
- easily adjustable
- with leather reins
- moulded noseband
- good quality leather
- Material: Leather
- without bit



Ref. no.	Colour		€
321178	black	1/25	
321179	brown	1/25	

genuine leather



Breastplate

- particularly soft and anatomically shaped
- simple mounting, adjustable size
- with rust-free fittings
- Material: Leather

Ref. no.	Size	Colour		€
3230214	Cob	black	1/30	
3230215	Full	black	1/30	
3230216	Cob	brown	1/30	
3230217	Full	brown	1/30	

New product

NEW

genuine leather



Bridle Reins

- with leather ends and martingale stopper



Ref. no.	Size	Colour	Length	Width		€
323593	Pony	black	240 cm	20 mm	1/50	
32664	Full	black	280 cm	20 mm	1/50	

Rubber reins AntiSlip

- rubberised for better grip • extremely durable • End pieces and stops made from soft leather



Ref. no.	Size	Colour	Length	Width		€
3222117	Full	black	3 m	15 mm	1/60	
3222118	Full	black / brown	3 m	15 mm	1/60	
32666	Full	black	3 m	20 mm	1/60	
3222116	Full	black / brown	3 m	20 mm	1/60	

Web Draw Reins with Split Leather Loops

- suitable for training by experienced riders • secured to the abdominal strap and guided through the snaffle bit - a very direct aid that requires experienced hands • web reins with soft leather loops • with saddle strap loop • quick and easy to remove



Important: draw reins can be a useful training aid. Please assess your riding skills honestly.

Ref. no.	Colour		€
3211763	black	1/50	

Thiedemann Reins

- classic Martingale rein combination • also called Köhler reins
- martingale with carabiner hook to hook into the D-rings • web reins with leather hand grips and 3 D-rings • not approved for tournaments as per LPO • Material: Leather



Ref. no.	Size	Colour		€
323595	Pony	black	1/25	
323594	Full	black	1/25	

genuine leather



Triangular Reins

- also called „Vienna reins“ • a modified form of side reins, creates more range of forward / backward movement for the horse than normal side reins or fixed training aids • the running side reins are approved for tournaments as per §70 LPO • adjustable • Material: Leather



genuine leather



Ref. no.	Size	Colour		€
323597	Pony	black	1/25	
323596	Full	black	1/25	

Neck Extender

- to correct throat and neck problems
- made from round rubber band
- steplessly adjustable
- highly elastic
- with plastic carabiner
- not approved for tournaments as per LPO



Ref. no.	Colour		€
323600	black	1/50/100	



Side reins

- with rubber ring
- rust-free fittings
- in pairs
- Material: Polyamide
- with carabiner hook



Ref. no.	Size	Colour		€
323599	Pony	black	1/35	
32660	Full	black	1/35	



Martingale

- prevents the horse from head banging
- sliding
- easily adjustable
- rust-free fittings
- includes martingale stopper
- Material: Leather



Ref. no.	Size	Colour		€
323598	Pony	black	1/50	
321754	Full	black	1/50	



genuine leather



Rein Stop

- Rubber for subsequent attachment to the bridle
- heat in a water bath and pull on the reins end



Ref. no.	Colour	Pieces / unit		€
321751/2	black	2 / pack	1/100	
3230218	brown	2 / pack	1/100	

NEW

Rein Stopper

- Rubber for subsequent attachment to the martingale
- prevents the martingale sagging in the front leg area



Ref. no.	Colour	Pieces / unit		€
321753/2	black	2 / pack	1/100	
3230219	brown	2 / pack	1/100	

NEW

Lunge

- widely applicable, for lunging and ground work
- with 9 rings
- Material: Polyamide
- adjustable
- washable at 30 °C



Ref. no.	Size	Colour	Belly circumference		€
32354	Pony	black	160 - 200 cm	1/30	
32339	Full	black	170 - 210 cm	1/30	

Lunging pad

The quilted, hard-wearing pad sits perfectly under any lunge girth, which can be easily fixed at the loops.

- made from durable quilted material
- with wide loops for easy fixation of the strap
- machine washable at 30 °C



Ref. no.	Colour	Length	Width		€
3228168	black	110 cm	28 cm	1/50	

Lunging Attachment

- made from 3-layer stitched webbing
- nickel-plated spring hook and swivel
- high-quality workmanship



Ref. no.	Colour		€
32640	black	1/100	

Lunging Whip

- with Nylon keeper
- Material: fibreglass, braided

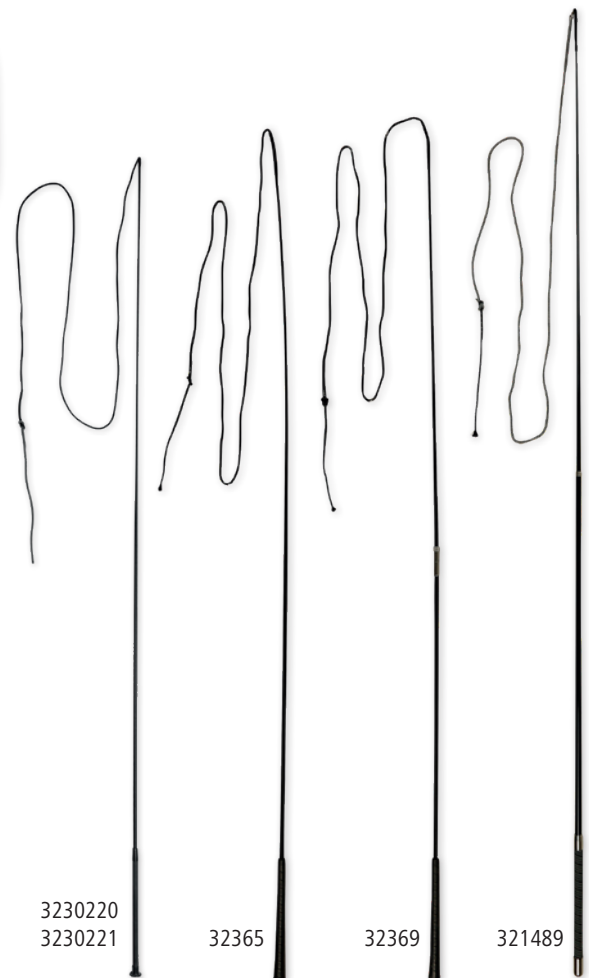

3230220
3230221

32365

32369

321489

Ref. no.	Description	Colour	Length		€
3230220	one-piece	black	160 cm	1/50	NEW NEW
3230221	one-piece	black	180 cm	1/50	
32365	one-piece	black	180 cm	1/70	
32369	two pieces with plug-in connection	black	180 cm	1/50	
321489	one piece, in a lightweight telescopic design	black	200 cm	1/50	

Cavesson Leather Exklusiv

- made from high-quality, durable leather
- soft crown piece and nose strap paddings
- with stable, silver mountings
- incl. removable bite strap
- multi-adjustable
- without bit

genuine leather



Ref. no.	Colour	Size		€
328649	black	Cob	1/15	
328650	black	Full	1/15	



Lunging Halter

- can be used for lunging and floor work
- with soft-padded, wide nose strap featuring three rings
- crown piece, neck and nose bands adjustable with pin buckles
- underlaid with soft padding
- made from wear-resistant material and strong seams
- sturdy, rust-free fittings can withstand even the toughest stresses
- metal eyelets prevent the pin buckles from working loose
- Material: Polypropylene

Ref. no.	Colour	Size		€
328651	black	Cob	1/25	
328652	black	Full	1/25	



Lunge line

- made of sturdy belt material (100 % polypropylene)
- with high-quality swivel and snap-hook
- with wrist loop



Ref. no.	Colour	Length		€
32148	black	7,5 m	1/45	
326057	dark blue	7,5 m	1/45	

Lunge Line with Leather Stops

- leather stops allow secure and stable hold of the lunge
- with large hand strap and rotating carabiner



Ref. no.	Colour	Length		€
321496	black	8 m	1/50	

Lunge line Softlonge

- soft mixed fabric for pleasant grip
- with large hand strap and rotating carabiner



Ref. no.	Colour	Length		€
321490	blue / violet	8 m	1/50	
321491	black / red	8 m	1/50	
322219	brown / light blue	8 m	1/50	

Double Lunge Soft

- soft mixed fabric for pleasant grip
- with large hand strap and rotating carabiner
- with 2 large rotating carabiners



Ref. no.	Colour	Length		€
3222120	black	17 m	1/25	

LED Helmet Light

• powerful helmet lamp with LED technology • very long service life thanks to low energy consumption • with individually adjustable light angle • different levels of brightness • very bright light thanks to 10 LEDs • can be easily attached to the helmet using elastic straps • stays firmly on the head • weatherproof • Battery not included

Ref. no.	Colour			€
324549	black / grey	1/100	400	

Technical data	324549
Light levels	4 light levels
Material	Plastic
Voltage	3 x 1.5 V - AAA (Micro)



with 10 LEDs



LED head lamp HeadFire 280 sensor

• powerful LED head lamp with motion sensor • COB LED (280 lumen) with 230° light angle for extremely bright, wide-area illumination • additional LED spotlight (100 lumens) on the side for targeted illumination • contactless switching on/off by hand movement thanks to motion sensor • ideal for working or activities in dark places: work, maintenance, outdoors, jogging, walking, riding and camping • with 5 light modes: COB LED 100 %, COB LED 25 %, spot 100 %, spot 25 % and flashing • elasticated headband can be adjusted to the size of the head or helmet • USB-C charging interface (rechargeable Li-Ion battery included) • incl. USB cable

Technical data	
Light levels	3 light levels
Light level modes	100 % / 25 % / Flashing
Battery charge time	2,5 h
Hours of light	~ 4 h
Protection class	IP22



New product 

Ref. no.	Colour	Luminous flux		€
345629	black	280 lm	1/50/100	

High Visibility Vest

• with 2 reflective strips
• unisize
• highly reflective
• EN ISO 20471:2013



Ref. no.	Colour	MOQ	Pieces / unit		€
34645/1	neon yellow	1 pack	1 / pack	1	

Reflective Armband

• elastic
• highly reflective
• with hook and loop fastener

Ref. no.	Colour	Length	Width		€
34646/1	neon yellow	340 mm	50 mm	1/100	



Reflective Safety Blanket

- for your safe ride in low visibility conditions
- with reflective stripes
- saddle cut-out and hook and loop fastener on the withers for securing
- tail strip ensures non-slip positioning
- 100 % polyester
- machine washable at 30 °C



Ref. no.	Colour	Back length		€
328508	neon yellow	135 cm	1/25	
328509	neon yellow	145 cm	1/20	

Illuminated gaiter LED

- variable LED illuminated gaiter • visible from a distance of up to 300 metres
- chargeable with supplied USB cable • depending on the mode of operation, up to 5 hours light duration • How it works: 3 x flashing light variants, of which 1 x continuous light • Material: PVC • in pairs

New product

NEW

Ref. no.		€
3230419	1/48	



Brow strap LED

- variable LED head strap • visible from a distance of up to 300 metres • chargeable with supplied USB cable • depending on the mode of operation, up to 5 hours light duration • How it works: 3 x flashing light variants, of which 1 x continuous light • Material: PVC

New product

NEW

Ref. no.		€
3230420	1/96	



Breastplate LED

- versatile LED breastplate • visible from a distance of up to 300 metres • chargeable with supplied USB cable • depending on the mode of operation, up to 5 hours light duration • How it works: 3 x flashing light variants, of which 1 x continuous light • Material: PVC

New product

NEW

Ref. no.		€
3230421	1/18	



Reflective Tail Guard

- bright yellow with reflective strips
- with fleece lining
- easy to adjust with hook and loop fastener
- perfect hold with fastener strap



Ref. no.	Colour	Length	Width		€
328514	neon yellow	44 cm	28 cm	1/125	

High-visibility gaiters

- highly reflective • for your safe ride in low visibility conditions • in pairs
- extremely durable • steplessly adjustable with hook and loop-fastener
- additional safety snap closure makes losing it impossible

Ref. no.	Colour	Size	Height		€
32491/1	neon yellow	M	6 cm	1/96	
32663/1	neon yellow	L	6 cm	1/96	

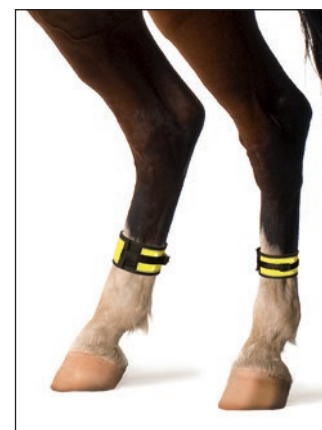

Reflective breastplate

The highly reflective breastplate provides additional safety for both the rider and horse. It is adjustable in size and can be used on all sizes of horse from pony to warmblood.

- for a safe ride in low-visibility conditions • highly reflective • steplessly adjustable straps for individual size adjustment • with two snap hooks for hanging on the saddle • 100 % polyester



Ref. no.		€
3228169	1/50	

Reflective snaffle and halter set

The highly reflective luminous covers fit all snaffles and halters and provide additional safety for the rider and horse.

- for a safe ride in low-visibility conditions • highly reflective
- easy to fix with hook-and-loop fasteners • fits on every snaffle and halter • 100 % polyester • three-part set (2 parts with 13.5 x 10 cm and 1 part with 13.5 x 20 cm)

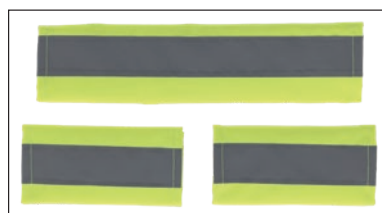

Ref. no.		€
3228170	1/50	



Halter TopLine

- nose and neck bands adjustable with buckles
- high-quality tape fabric
- made from wear-resistant material and strong seams
- triple stitched cheek and chin straps
- solid and elegant fittings
- easy to open and close the halter using carabiner hook
- 2-way adjustable



€

1/50

Halter size	Pony	Cob	Full	XFull
navy	3224611	3224612	3224613	3224614
black	3224615	3224616	3224617	3224618
forest	3224619	3224620	3224621	3224622



Foal Head-Collar TopLine

- neck and nose bands adjustable with pin buckles
- high-quality tape fabric
- made from wear-resistant material and strong seams
- triple stitched cheek and chin straps
- solid and elegant fittings
- easy to open and close the halter using carabiner hook
- tape width: 20 mm
- 2-way adjustable



€

1/50

Halter size	Foal
navy	3224747
black	3224748
forest	3224749



Lead Rope TopLine

- attractive, sturdy lead rope
- colour-matched to the TopLine halter



Ref. no.	Fastener type	Colour	Length		€
3224623	Snap-hook	navy	2 m	1/50	
3224624	Panic hook	navy	2 m	1/50	
3224625	Snap-hook	black	2 m	1/50	
3224626	Panic hook	black	2 m	1/50	
3224627	Snap-hook	forest	2 m	1/50	
3224628	Panic hook	forest	2 m	1/50	

Horse Halters Royal

- lavishly stitched and detailed horse halter made from high-quality materials
- with colour-coordinated design fitting components
- soft padding made from fur-friendly synthetic rubber
- can be perfectly adjusted using the pin buckle on the neck and nose bands



€

1/50

Halter size	Foal	Shetty	Pony	Cob	Full	XFull
black / fuchsia	3228171	3228172	3228173	3228174	3228175	3228176
blue / caramel	3228177	3228178	3228179	3228180	3228181	3228182
brown / light blue	3228183	3228184	3228185	3228186	3228187	3228188

Halter Classy

- classically elegant halter
- adjustable neck and nose bands with buckles and a soft padding layer
- made from wear-resistant material and strong seams
- easy to open and close the halter using carabiner hook
- solid and elegant fittings
- metal eyelets prevent the pin buckles from working loose



 €
 1/50

Halter size	Shetty	Pony	Cob	Full
navy	3224729	3224730	3224731	3224732
stone	3224733	3224734	3224735	3224736
merlot	3224737	3224738	3224739	3224740



Lead Rope Classy

- attractive, sturdy lead rope
- colour-matched to the Classy halter



Ref. no.	Fastener type	Colour	Length		€
3224741	Snap-hook	navy	2 m	1/50	
3224742	Panic hook	navy	2 m	1/50	
3224743	Snap-hook	stone	2 m	1/50	
3224744	Panic hook	stone	2 m	1/50	
3224745	Snap-hook	merlot	2 m	1/50	
3224746	Panic hook	merlot	2 m	1/50	

Halter Doria

Classic sleek halter in modern colours, matches the Doria lead rope, with pleasantly upholstered neck and nose strap for more wearing comfort.

- soft neck and nose paddings
- neck and nose bands steplessly adjustable
- throat strap easy to open by carabiner
- rust-free fittings



Halter size	Shetty	Pony	Cob	Full
black	3228195	3228196	3228197	3228198
navy	3228199	3228200	3228201	3228202
jade green	3228203	3228204	3228205	3228206



Lead Rope Doria

Soft horse rope with good grip and robust metal hook for leading and tethering.

- extra-thick lead rope with good grip
- available colour-matched to the Doria halter



Ref. no.	Fastener type	Colour	Length		€
3228211	Snap-hook	black	2 m	1/25	
3228212	Panic hook	black	2 m	1/25	
3228213	Snap-hook	navy	2 m	1/50	
3228214	Panic hook	navy	2 m	1/50	
3228215	Snap-hook	jade green	2 m	1/25	
3228216	Panic hook	jade green	2 m	1/25	

Halter SuperSoft

- super-soft halter with faux fur for maximum comfort
- made from wear-resistant material and strong seams
- Adjustable neck band
- easy to open and close the halter using carabiner hook
- solid metal fittings



 €
 1/25

Halter size	Pony	Cob	Full
black	3224638	3224639	3224640
navy	3224641	3224642	3224643



Lead Rope Supreme

- lead rope with particularly excellent grip made from woven polypropylene



Ref. no.	Fastener type	Colour	Length		€
328239	Snap-hook	bordeaux	200 cm	1/50	
328240	Panic hook	bordeaux	200 cm	1/50	
328241	Snap-hook	black	200 cm	1/50	
328242	Panic hook	black	200 cm	1/50	
328263	Snap-hook	forest	200 cm	1/50	
328264	Panic hook	forest	200 cm	1/50	

Lead Rope Reflective

- ideal for darker seasons
- attractive, sturdy lead rope
- with integrated, reflective yarn
- matches the Halter Reflective



Ref. no.	Fastener type	Colour		€
3224647	Snap-hook	black / silver	1/50	
3224648	Panic hook	black / silver	1/50	

Reflective 

Halter ClassicSoft

- no chafing, especially for sensitive horses, thanks to fluffy girth pads
- made from wear-resistant material and strong seams
- nose and neck strap adjustable
- easy to open and close the halter using carabiner hook
- Faux fur padding on neck and nose bands



€

1/25

Halter size	Shetty	Pony	Cob	Full
navy	3224750	3224751	3224752	3224753
black	3224754	3224755	3224756	3224757
stone	3224758	3224759	3224760	3224761
cappuccino	3224762	3224763	3224764	3224765

Lead Rope ClassicSoft

- attractive, sturdy lead rope
- colour-matched to the ClassicSoft halter



Ref. no.	Fastener type	Colour	Length		€
3224766	Snap-hook	navy	2 m	1/50	
3224767	Panic hook	navy	2 m	1/50	
3224768	Snap-hook	black	2 m	1/50	
3224769	Panic hook	black	2 m	1/50	
3224770	Snap-hook	stone	2 m	1/50	
3224771	Panic hook	stone	2 m	1/50	
3224772	Snap-hook	cappuccino	2 m	1/50	
3224773	Panic hook	cappuccino	2 m	1/50	

Halter Mustang

- top quality halter with subtle pattern
- made from wear-resistant polyamide and strong seams
- adjustable with buckles for nose- and neckband
- easy to open and close using carabiner hook
- padded crownpiece and noseband



 €
 1/50

Halter size	Pony	Cob	Full
black / silver	321960	321965	321970
red / black	321961	321966	321971
royal blue / black	321962	321967	321972



Lead Rope Mustang

- colour-matched to the Mustang halter
- lead rope with particularly excellent grip made from woven polypropylene



Ref. no.	Fastener type	Colour	Length		€
321423	Snap-hook	black / white	200 cm	1/50	
321433	Panic hook	black / white	200 cm	1/50	
321435	Snap-hook	red / black / white	200 cm	1/50	
321437	Panic hook	red / black / white	200 cm	1/50	
321436	Snap-hook	blue / black / white	200 cm	1/50	
321438	Panic hook	blue / black / white	200 cm	1/50	

Halter Hippo

- affordable quality
- neck band steplessly adjustable
- throat strap easy to open by carabiner
- rust-free fittings



Description		€
Foal - Shetty	1/120	
Pony – XFull	1/100	

Halter size	Foal	Shetty	Pony	Cob	Full	XFull
black	3222123	3222124	3222125	3222126	3222127	3222128
navy blue	3222129	3222130	3222131	3222132	3222133	3222134
aubergine	3222135	3222136	3222137	3222138	3222139	3222140
blue	3230422	3230423	3230424	3230425	3230426	3230427
orange	3230428	3230429	3230430	3230431	3230432	3230433
pink	3230434	3230435	3230436	3230437	3230438	3230439
navy blue / light blue	321903	321913	321923	321933	321943	
anthracite / light green	325902	325904	325906	325908	325910	
bordeaux / beige	328260	328259	328243	328244	328245	

NEW
NEW
NEW

Lead Rope Hippo

- suitable for head collar Hippo
- made from woven PE
- extremely soft and therefore easy to grip
- in attractive colours



Ref. no.	Fastener type	Colour	Length		€
3230440	Panic hook	blue	200 cm	1/50	NEW
3230441	Snap-hook	blue	200 cm	1/50	NEW
3230442	Panic hook	orange	200 cm	1/50	NEW
3230443	Snap-hook	orange	200 cm	1/50	NEW
3230444	Panic hook	pink	200 cm	1/50	NEW
3230445	Snap-hook	pink	200 cm	1/50	NEW
3222141	Snap-hook	aubergine / anthracite	200 cm	1/50	
3222142	Panic hook	aubergine / anthracite	200 cm	1/50	
321441	Snap-hook	black / grey	200 cm	1/50	
321451	Panic hook	black / grey	200 cm	1/50	
325898	Snap-hook	anthracite / light green	200 cm	1/50	
325900	Panic hook	anthracite / light green	200 cm	1/50	
325914	Snap-hook	bordeaux / beige	200 cm	1/50	
325915	Panic hook	bordeaux / beige	200 cm	1/50	
321440	Snap-hook	light blue / dark blue	200 cm	1/50	
321450	Panic hook	light blue / dark blue	200 cm	1/50	

Halter Cordano

- an attractive combination of round and flat bands
- made from wear-resistant material and strong seams
- nose and neck bands adjustable with buckles
- easy to open and close the halter using carabiner hook
- solid and elegant fittings
- Neck Strap with Faux Fur Padding



€	Halter size	Pony	Cob	Full
1/25	smoked blue	3297737	3297738	3297739
	oliv	3297740	3297741	3297742

Halter Eco

- made from durable leather
- double stitched for excellent durability
- heavyweight brass fitting
- Neck and nose bands optimally adjustable with pin buckles



Description	€
Pony – Cob	1/25
Full – XFull	1/20

genuine leather



Halter size	Pony	Cob	Full	XFull
black	32255	32256	32257	32258
brown	32265	32266	32267	32259

Foal Head-Collar Eco

- hardwearing leather halter
- tailored to the needs of a foal: narrow leather strap, lightweight yet robust fittings and easily adjustable

Ref. no.	Colour	 1/50	€
327040	brown	1/50	
327041	black	1/50	

genuine leather



Knotted Halter

- suitable for all horse types
- double knots for improved effectiveness on the nose piece
- adjustable with knots
- with double neck and nose piece
- made of stable, woven polypropylene fabric

New product 

 1/50	€	Halter size	Pony	Cob	Full
		dark blue	3230222	3230223	3230224



Knotted Halter

- sturdy woven fabric
- adjustable with knots
- with double neck and nose piece
- suitable for all horse types
- Material: Polypropylene





 1/50	€	Halter size	Pony	Cob	Full
		navy / beige	3297743	3297744	3297745
		black / grey	3297746	3297747	3297748



Muzzle Teddy Fleece

- prevents your horse from eating too hastily in the pasture
- comfortable design with faux fur padding inside the basket, around the nose and on the neckband
- Mouth area is made of sturdy but flexible plastic
- incl. ring on the base of the basket for leading over short distances - not suitable for tethering
- can be flexibly adjusted to get the perfect size





Ref. no.	Colour	Size			€
3222146	black	Shetty	1/20	200	
3222143	black	Pony	1/20	200	
3222144	black	Cob	1/20	200	
3222145	black	Full	1/20	200	



Muzzle

- prevents your horse from eating too hastily in the pasture
- with reinforcement in the mouth area
- easy to mount



Ref. no.	Colour	Size			€
325870	black	Shetty	1/20	360	
321625	black	Pony	1/20	240	
321626	black	Cob	1/20	200	
321627	black	Full	1/20	200	



Neck Strap

- sturdy belt made from polyamide
- Stainless steel metal parts
- warmblood



Ref. no.	Colour	Width	Size			€
32340	black	5 cm	Full	1/50	200	



American Lead Rope

- durable knit with a sophisticated look
- made from tear-resistant nylon with large snap hook



Ref. no.	Colour	Length		€
3222147	black / grey	250 cm	1/30	

Cotton leash with chain

- soft, hand-friendly design
- extremely stable thanks to multiple braiding
- total length 2 m incl. chain



Ref. no.	Colour	Length		€
3226344	blue	200 cm	1/25	
3226345	black	200 cm	1/25	

Guide Leash with Chain

- double stitched
- excellent workmanship



Ref. no.	Colour	Length		€
32147	black	250 cm	1/75	

Lead rope cotton

- thick design
- high-quality braided cotton lead rope



Ref. no.	Fastener type	Colour	Length		€
3210504	Panic hook	dark blue	200 cm	1/50	
3210507	Snap-hook	dark blue	200 cm	1/50	
3210505	Panic hook	black	200 cm	1/50	
3210508	Snap-hook	black	200 cm	1/50	

Lead Rope Bull-Snap

- extra-thick design
- slip-proof material (polypropylene)

especially stable Bull-Snap



Ref. no.	Colour	Length	Ø		€
32160	black	230 cm	20 mm	1/50	

Ground Work Rope

- stable lead rope with excellent grip made from woven polypropylene
- with double leather strap and Bull-Snap



Ref. no.	Colour	Length		€
322694	black / white	4 m	1/50	
3228219	black	4 m	1/50	

Outdoor Horse Blanket RugBe

The right blanket for every temperature! Optimal fit and sufficient freedom of movement don't have to be mutually exclusive! The Outdoor Blanket RugBe combines both features in a new design. The newly developed bib allows for ground-covering movements by the horse on the one hand, and a perfect fit on the other.

- cosy polyester lining that does not chafe the coat
- keeps the horse dry from the outside and regulates temperature
- High-quality, tear-resistant 600 Denier polyester
- Classic cut
- surcingle on belly
- with tail flap, leg straps and synthetic rubber withers cushioning
- overlapping chest buckles with quick-fastening thanks to metal carabiners and pin buckles
- extremely water-repellent up to a 3000 mm water column
- 3000 g/m²/24 h (air permeability)

Ref. no.	Description	Colour	Back length	Total length		€	
3226346	0 g	dark navy	105 cm	155 cm	1/10		
3226347	0 g	dark navy	115 cm	165 cm	1/10		
3226348	0 g	dark navy	125 cm	175 cm	1/10		
3226349	0 g	dark navy	135 cm	185 cm	1/10		
3226350	0 g	dark navy	145 cm	195 cm	1/10		
3226351	0 g	dark navy	155 cm	205 cm	1/10		
3226352	0 g	dark navy	165 cm	215 cm	1/10		
3230446	50 g	dark navy	105 cm	155 cm	1/10		NEW
3230447	50 g	dark navy	115 cm	165 cm	1/10		NEW
3230448	50 g	dark navy	125 cm	175 cm	1/10		NEW
3230449	50 g	dark navy	135 cm	185 cm	1/10		NEW
3230450	50 g	dark navy	145 cm	195 cm	1/10		NEW
3230451	50 g	dark navy	155 cm	205 cm	1/10		NEW
3230452	50 g	dark navy	165 cm	215 cm	1/10		NEW
3230453	100 g	dark navy	105 cm	155 cm	1/10		NEW
3230454	100 g	dark navy	115 cm	165 cm	1/10		NEW
3230455	100 g	dark navy	125 cm	175 cm	1/10		NEW
3230456	100 g	dark navy	135 cm	185 cm	1/10		NEW
3230457	100 g	dark navy	145 cm	195 cm	1/10		NEW
3230458	100 g	dark navy	155 cm	205 cm	1/10		NEW
3230459	100 g	dark navy	165 cm	215 cm	1/10		NEW
3226364	200 g	dark navy	105 cm	155 cm	1/8		
3226365	200 g	dark navy	115 cm	165 cm	1/8		
3226366	200 g	dark navy	125 cm	175 cm	1/8		
3226367	200 g	dark navy	135 cm	185 cm	1/8		
3226368	200 g	dark navy	145 cm	195 cm	1/8		
3226369	200 g	dark navy	155 cm	205 cm	1/8		
3226370	200 g	dark navy	165 cm	215 cm	1/8		
3226375	300 g	dark navy	105 cm	155 cm	1/6		
3226376	300 g	dark navy	115 cm	165 cm	1/6		
3226377	300 g	dark navy	125 cm	175 cm	1/6		
3226378	300 g	dark navy	135 cm	185 cm	1/6		
3226379	300 g	dark navy	145 cm	195 cm	1/6		
3226380	300 g	dark navy	155 cm	205 cm	1/6		
3226381	300 g	dark navy	165 cm	215 cm	1/6		

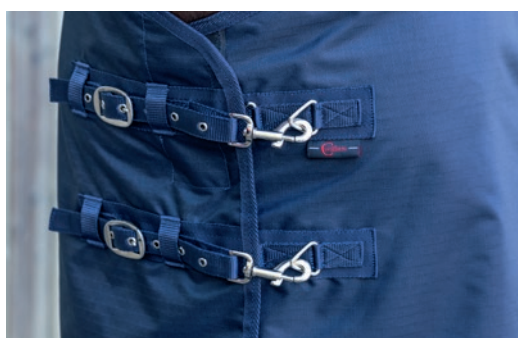



Neckpiece RugBe Zero

Matching neck piece for our RugBe Outdoor and Winter Blankets. The neck piece is attached to the blanket on the left and right using hook and loop fastener and loops.

- without filling for all-year-round use • High-quality, tear-resistant 600 Denier polyester • pleasant internal lining that does not chafe the coat • suitable for all RugBe Outdoor and IceProtect versions • easy to attach with loops and hook-and-loop fasteners • 3.000 mm water column • breathable to 3,000 gsm/24 h



Ref. no.	Colour	Size		€
3226353	dark navy	XS	1/15	
3226354	dark navy	S	1/15	
3226355	dark navy	M	1/15	
3226356	dark navy	L	1/15	

Neckpiece RugBe IceProtect 200

Matching neck piece for our RugBe Outdoor and Winter Blankets series. The neck piece is attached left and right using hook and loop fastener and loops on the blanket.

- filled with warm 200 g thermal fleece • High-quality, tear-resistant 600 Denier polyester • pleasant internal lining that does not chafe the coat • 3.000 mm water column • breathable to 3,000 gsm/24 h



Ref. no.	Colour	Size		€
3226371	dark navy	XS	1/12	
3226372	dark navy	S	1/12	
3226373	dark navy	M	1/12	
3226374	dark navy	L	1/12	

Outdoor Horse Blanket RugBe HighNeck

Outdoor horse blanket for all year round

- with mid-height collar for additional protection
- keeps the horse dry from the outside and regulates temperature
- cosy polyester lining that does not chafe the coat
- excellent fit with increased freedom of movement thanks to the RugBe kick pleat
- with tail strip and elastic leg straps
- surcingle on the belly with elastic insert
- overlapping chest buckles with quick-fastening thanks to metal carabiners and pin buckles
- extremely water-repellent up to a 3000 mm water column
- 3000 g/m²/24 h (air permeability)



Ref. no.	Colour	Back length	Total length	Back length incl. neck		€
3226357	dark navy	105 cm	155 cm	160 cm	1/10	
3226358	dark navy	115 cm	165 cm	170 cm	1/10	
3226359	dark navy	125 cm	175 cm	180 cm	1/10	
3226360	dark navy	135 cm	185 cm	190 cm	1/10	
3226361	dark navy	145 cm	195 cm	200 cm	1/10	
3226362	dark navy	155 cm	205 cm	210 cm	1/10	
3226363	dark navy	165 cm	215 cm	220 cm	1/10	

Under-/stable blanket RugBe 2in1

- breathable and heat-regulating under-blanket
- can also be used as a light stable blanket
- 100 g thermal fleece for ideal conditions
- pleasant internal lining that does not chafe the coat
- with chest buckle and tail strap
- easy to clean
- washable at 30 °C



Ref. no.	Colour	Back length	Total length		€
3226384	navy	105 cm	155 cm	1/10	
3226385	navy	115 cm	165 cm	1/10	
3297763	navy	125 cm	175 cm	1/10	
3297764	navy	135 cm	185 cm	1/10	
3297765	navy	145 cm	195 cm	1/10	
3297766	navy	155 cm	205 cm	1/10	
3297767	navy	165 cm	215 cm	1/10	

Stable Blanket RugBe

- attractive stable blanket with broad quilting and outer abdominal cross-straps
- with broad tail strip and adjustable leg straps
- double chest buckle with pin buckle, snap-hooks and D-rings
- filled with 150 g of thermal fleece fabric
- breathable material for ideal conditions under the blanket
- pleasant inner lining made from polyester that does not chafe the coat
- 300 Denier polyester outer material



Ref. no.	Colour	Back length	Total length		€
3226382	blue	105 cm	155 cm	1/8	
3226383	blue	115 cm	165 cm	1/8	
325416	blue	125 cm	175 cm	1/8	
325417	blue	135 cm	185 cm	1/8	
325418	blue	145 cm	195 cm	1/8	
325419	blue	155 cm	205 cm	1/8	
325433	blue	165 cm	215 cm	1/8	

Walking blanket RugBe

- made from high-quality, durable polyester material with TPU membrane
- keeps the horse dry and regulates temperature
- warming and moisture-wicking fleece lining
- protects the horse's sensitive kidney area from moisture and cold
- with tail strip
- 5.000 mm water column
- 3000 g/m²/24 h (air permeability)

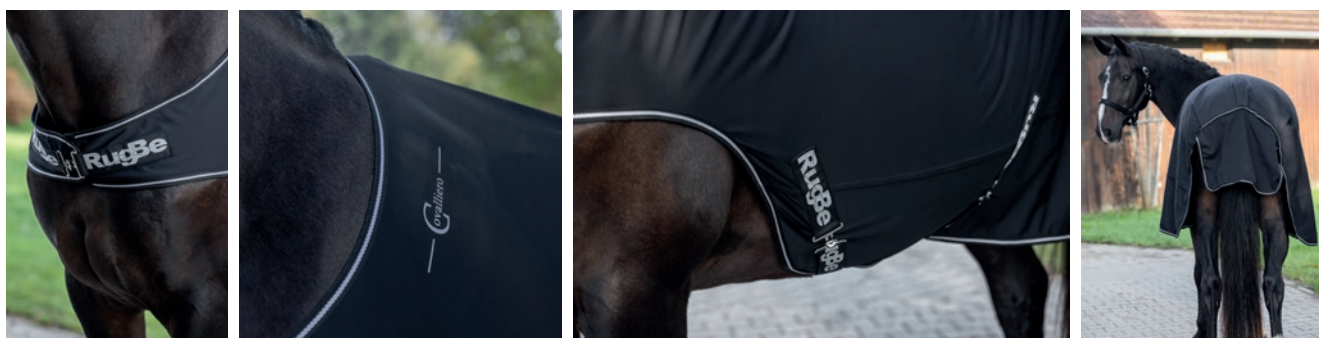
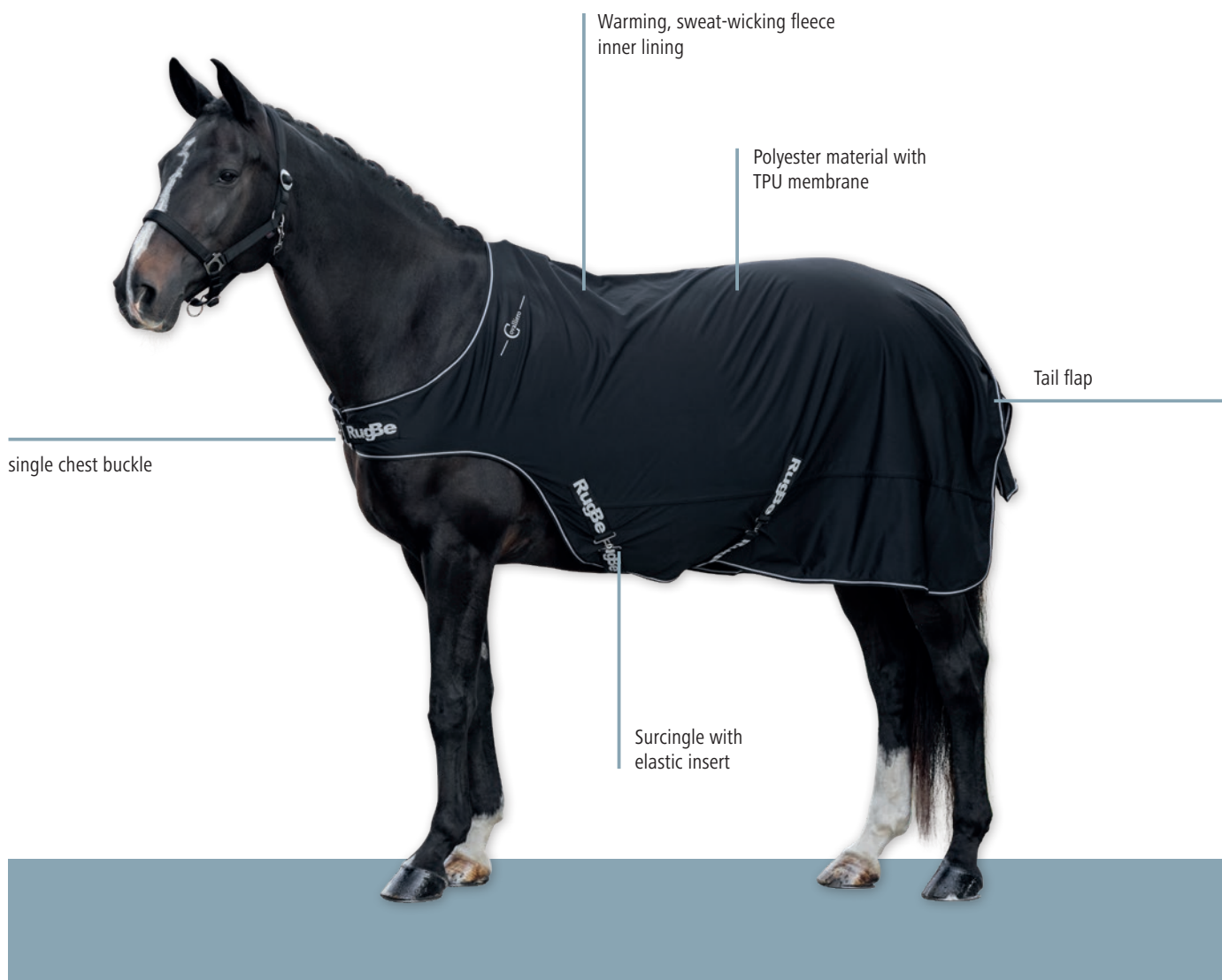

Ref. no.	Colour	Back length		€
3228275	black	115 cm	1/15	
3228276	black	130 cm	1/15	
3228277	black	145 cm	1/15	
3228278	black	155 cm	1/15	

Fleece Blanket RugBe Economic

- lightweight micro-fleece transport and sweat blanket
- with chest buckle and tail strap
- wicks the sweat away from the body and keeps your horse dry as well as protecting it from draughts
- fleece withers cushion
- machine washable at 30 °C



Ref. no.	Colour	Back length	Total length		€
3226400	black	105 cm	155 cm	1/15	
3226401	black	115 cm	165 cm	1/15	
328677	black	125 cm	175 cm	1/15	
328678	black	135 cm	185 cm	1/15	
328679	black	145 cm	195 cm	1/15	
328680	black	155 cm	205 cm	1/15	
3211608	black	165 cm	215 cm	1/15	
3226402	navy	105 cm	155 cm	1/15	
3226403	navy	115 cm	165 cm	1/15	
328681	navy	125 cm	175 cm	1/15	
328682	navy	135 cm	185 cm	1/15	
328683	navy	145 cm	195 cm	1/15	
328684	navy	155 cm	205 cm	1/15	
3211609	navy	165 cm	215 cm	1/15	

Fleece Blanket RugBe Royal

Super-lightweight transport and sweat blanket.

- fleecy, soft Teddy fleece collar
- fast absorption of moisture
- with chest buckle and tail strap
- adjustable and removable cross straps
- breathable
- machine washable at 30 °C



Ref. no.	Colour	Back length	Total length		€
3228220	graphite	105 cm	155 cm	1/10	
3228221	graphite	115 cm	165 cm	1/10	
3228222	graphite	125 cm	175 cm	1/10	
3228223	graphite	135 cm	185 cm	1/10	
3228224	graphite	145 cm	195 cm	1/10	
3228225	graphite	155 cm	205 cm	1/10	
3228226	graphite	165 cm	215 cm	1/10	
3228227	dark navy	105 cm	155 cm	1/10	
3228228	dark navy	115 cm	165 cm	1/10	
3228229	dark navy	125 cm	175 cm	1/10	
3228230	dark navy	135 cm	185 cm	1/10	
3228231	dark navy	145 cm	195 cm	1/10	
3228232	dark navy	155 cm	205 cm	1/10	
3228233	dark navy	165 cm	215 cm	1/10	

Horse Blankets

Fly blanket RugBe SuperFly

- lightweight and robust blanket made from especially pleasant material for pasture and paddock
- shiny, breathable material protects against overheating
- narrow mesh, soft polyester provides perfect protection from annoying flies, stinging and biting insects
- removable, elastic leg straps prevent the blanket from slipping
- removable throat section, fastened with hook and loop fasteners
- large tail flap
- with hook and loop fasteners in the neck and chest area
- lined chest area
- UV resistance
- machine washable at 30 °C



suitable for: Fly Mask SuperFly 3210313 - 3210315, 3230232 - 3230234



Ref. no.	Colour	Back length	Total length		€	
3230225	navy	105 cm	155 cm	1/15		NEW
3230226	navy	115 cm	165 cm	1/15		NEW
3230227	navy	125 cm	175 cm	1/15		NEW
3230228	navy	135 cm	185 cm	1/15		NEW
3230229	navy	145 cm	195 cm	1/15		NEW
3230230	navy	155 cm	205 cm	1/15		NEW
3230231	navy	165 cm	215 cm	1/15		NEW
328962	white	105 cm	155 cm	1/15		
328963	white	115 cm	165 cm	1/15		
328692	white	125 cm	175 cm	1/15		
328693	white	135 cm	185 cm	1/15		
328694	white	145 cm	195 cm	1/15		
328695	white	155 cm	205 cm	1/15		
328696	white	165 cm	215 cm	1/15		

Fly blanket RugBe Zebra

Fly and eczema blanket with neck section

- integrated neck section with hook and loop fastener
- narrow mesh soft polyester and zebra look provides perfect protection from annoying flies, stinging and biting insects
- lined chest area
- with elastic leg straps and RugBe kick pleat
- securable belly guard with elastic strapping
- large tail flap
- UV resistance
- machine washable at 30 °C



suitable for: Fly Mask RugBe Zebra 326113 - 326115

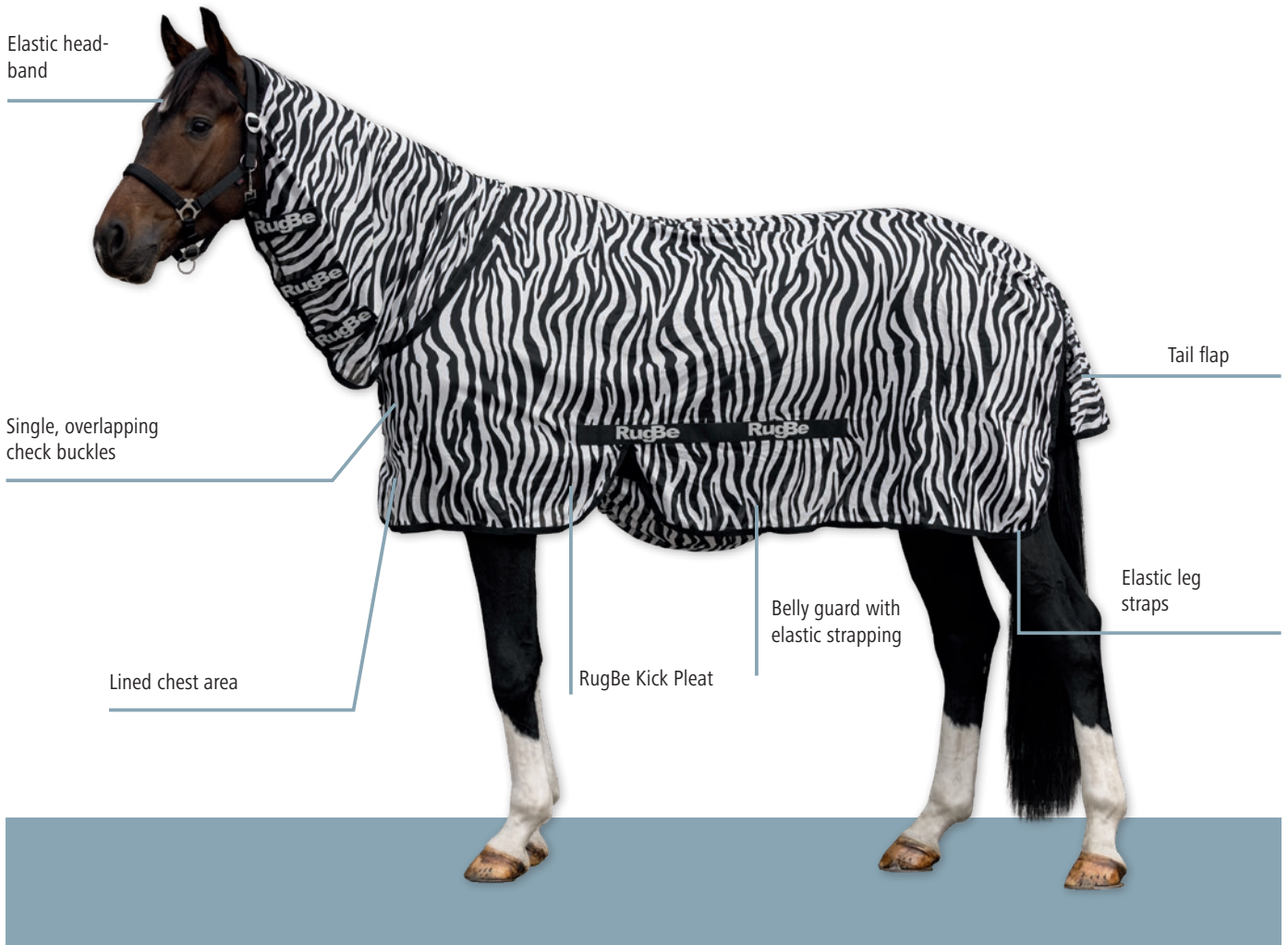

Ref. no.	Colour	Back length	Total length		€
326122	Zebra look	125 cm	175 cm	1/15	
326123	Zebra look	135 cm	185 cm	1/15	
326124	Zebra look	145 cm	195 cm	1/15	
326125	Zebra look	155 cm	205 cm	1/15	
326126	Zebra look	165 cm	215 cm	1/15	

Tail Guard

- made from elastic, stable and soft synthetic rubber
- with hook and loop fastener and metal ring
- protects the tail root and hair
- ideal for transport



Ref. no.	Colour		€
328657	black	1/50	

Leg Straps for RugBe Blankets

- in pairs
- with sliding buckle
- steplessly adjustable



Ref. no.	Fastener type	Colour		€
3223342	Snap Hook	black	1/100	

Surcingle elastic

- highly elastic waistband for ease of movement
- steplessly adjustable from 110 - 250 cm
- with patent closure



Ref. no.	Colour	Width		€
32346	black	8 cm	1/100	

Chest extension

for outdoor horse blankets

- allows more freedom of movement
- for horses with a wide chest
- High-quality, tear-resistant 600 Denier polyester
- with two straps incl. carabiner hook and two D-rings



Ref. no.	Colour	Length	Width		€
3230118	navy	30 cm	30 cm	1/30	

NEW

sheathed tail strap

- practical tail strap made of elastic material
- easy to clean thanks to plastic housing

3228234: suitable for blanket length 115 - 140 cm

3228235: suitable for blanket length 145 - 165 cm

Ref. no.	Length		€
3228234	39 cm	1/100	
3228235	57 cm	1/100	



Fly Mask with Ear Protection and Nostril Cord

- with cords for repelling flies and other insects away from the sensitive nostril area
- ear area made from elastic, pleasantly soft fabric
- with fleece padding to prevent rubbing
- easily fixed to the horse's head with hook and loop fastenings



new design with integrated eye spacers

Ref. no.	Colour	Size		€
321267	black	Pony	1/50	
321268	black	Cob	1/50	
321269	black	Full	1/50	

Fly Mask with Ear and Nose Protection

- incorporated fly barrier between nostril and eye area
- ear area made from elastic, pleasantly soft fabric
- with fleece padding to prevent rubbing
- easily fixed to the horse's head with hook and loop fastenings



new design with integrated eye spacers

Ref. no.	Colour	Size		€
321273	black	Pony	1/50	
321275	black	Cob	1/50	
321274	black	Full	1/50	

Fly Mask with Ear and Nostril Protection

- ear area made from soft, comfortable and breathable mesh fabric
- with UV protection
- with fleece padding to prevent rubbing
- easily fixed to the horse's head with hook and loop fastenings

with UV protection

Ref. no.	Colour	Size		€
3230235	light grey	Pony	1/50	
3230236	light grey	Cob	1/50	
3230237	light grey	Full	1/50	
3230238	navy	Pony	1/50	
3230239	navy	Cob	1/50	
3230240	navy	Full	1/50	



New product 

Fly Mask with Ear Cut-outs

- sturdy yet lightweight mesh fabric
- with fleece padding to prevent rubbing
- easily fixed to the horse's head with hook and loop fastenings

new design with integrated eye spacers

Ref. no.	Colour	Size		€
321351	black	Pony	1/50	
321353	black	Cob	1/50	
321352	black	Full	1/50	



Halter with Integrated Fly Mask

The halter with integrated fly mask can be perfectly adapted to any horse's head by means of a stretchy Lycra insert with hook-and-loop fastener in the nose area.

- no slipping thanks to integrated halter
- flexible Lycra material and hook-and-loop fastener in the nose area for perfect adaptation to the horse's head
- with ear protection
- fine-meshed, stable mesh material
- double-stitched, soft and skin-friendly fabric
- throat strap easy to open by carabiner
- neck and nose bands steplessly adjustable

Ref. no.	Colour	Size		€
3228236	black	Pony	1/50	
3228237	black	Cob	1/50	
3228238	black	Full	1/50	



Fly Mask with Ear Protection SuperFly

- lightweight, tear-resistant and close-knit mesh fabric made from polyester
- easily fixed to the head using hook-and-loop fasteners
- elastic binding for perfect fit to the shape of the head



matches the fly blanket RugBe SuperFly 328962 - 328696, 3230225 - 3230231

Ref. no.	Colour	Size		€
3210313	white	Pony	1/50	
3210314	white	Cob	1/50	
3210315	white	Full	1/50	
3230232	navy	Pony	1/50	NEW
3230233	navy	Cob	1/50	NEW
3230234	navy	Full	1/50	NEW



Fly Mask Zebra with Ear Protection

- matches the Fly Blanket Rugbe Zebra
- lightweight, tear-resistant and close-knit mesh fabric made from polyester
- easily fixed to the horse's head with hook and loop fastenings
- elastic binding for perfect fit to the shape of the head



suitable for: Fly Blanket RugBe Zebra 326122 - 326126

Ref. no.	Colour	Size		€
326113	Zebra look	Pony	1/50	
326114	Zebra look	Cob	1/50	
326115	Zebra look	Full	1/50	



Fly Mask with Ear Protection

- ear area made from soft, comfortable and breathable mesh fabric • with UV protection • with fleece padding to prevent rubbing • easily fixed to the horse's head with hook and loop fastenings

with UV protection

Ref. no.	Colour	Size		€
324515	light grey	Pony	1/50	
324516	light grey	Cob	1/50	
324517	light grey	Full	1/50	
3230463	navy	Pony	1/50	NEW
3230464	navy	Cob	1/50	NEW
3230465	navy	Full	1/50	NEW



Fly Bonnet FinoStretch

- tight-fitting fly mask with generously moulded eye area • particularly fine-meshed net fabric that even tiny flies cannot get through • pleasantly lightweight, elastic polyester fabric for a perfect fit

Ref. no.	Colour	Size		€
3229050	black	Pony	1/50	
3229051	black	Cob	1/50	
3229052	black	Full	1/50	
3229053	blue	Pony	1/50	
3229054	blue	Cob	1/50	
3229055	blue	Full	1/50	



Fly Bonnet FinoStretch Zipper

- tight-fitting fly mask with generously moulded eye area • particularly fine-meshed net fabric that even tiny flies cannot get through • pleasantly lightweight, elastic polyester fabric for a perfect fit • easy to put on and take off with a zip fastener

Ref. no.	Colour	Size		€
3230460	navy	Pony	1/100	
3230461	navy	Cob	1/100	
3230462	navy	Full	1/100	
3230540	black	Pony	1/100	
3230541	black	Cob	1/100	
3230542	black	Full	1/100	



New product 

Fly thread strap

- with hook and loop closure for easy hanging in halters and bridles
- protects eyes against horseflies and flies
- supplied without holster

Ref. no.	Colour	Size		€
321890	black	Pony	1/50	
321892	black	Cob	1/50	
321891	black	Full	1/50	
321893	blue	Pony	1/50	
321895	blue	Cob	1/50	
321894	blue	Full	1/50	



Fly Mask Linea

- protects ears from flies and horse flies
- with elastic ears
- crocheted with stylish leather appliqué
- machine washable at 30 °C

New product 

suitable for Saddle Pad Linea

Ref. no.	Colour	Size		€
3230466	dark navy	Pony	1/50	
3230467	dark navy	Cob / Full	1/50	
3230468	black	Pony	1/50	
3230469	black	Cob / Full	1/50	
3230470	white	Pony	1/50	
3230471	white	Cob / Full	1/50	
3230472	brown	Pony	1/50	
3230473	brown	Cob / Full	1/50	



Fly Mask Empara

- with subtle glitter appliqués
- protects ears from flies and horse flies
- with elastic ears
- crocheted
- machine washable at 30 °C



Ref. no.	Colour	Size		€
3297773	black	Cob / Full	1/100	
3297774	navy	Cob / Full	1/100	
3297775	white	Cob / Full	1/100	



Fly Mask Classic

- protects ears from flies and horse flies
- with elastic ears
- crocheted
- machine washable at 30 °C



Ref. no.	Colour	Size		€
323618	black	Full	1/100	
323619	white	Full	1/100	



Transport Gaiters Dexter

- 4-pce set
- high-quality transport boots
- lined with soft faux fur
- simple handling thanks to 3-way hook and loop fastener
- with extra reinforcement in the ball area
- filling made from high-density foam
- tall design with ankle protection (rear)
- easily securable with hook and loop fastening tab
- machine washable at 30 °C





Ref. no.	Colour	Size		€
32452	dark blue	Full	1/10	
3297779	dark blue	XFull	1/10	

Stable and Transport Gaiters

- Set with 4 travel gaiters incl. insert set (2 front / 2 back)
- outer material made from soft, shock-absorbent and heat-insulating synthetic rubber
- Removable fabric inner and washable with soft polyester fleece lining and microfibre sheath
- good hook and loop fasteners for best grip
- machine washable at 30 °C



Ref. no.	Colour	Size	Size		€
32469	black	M	Cob	1/10	
32470	black	L	Full	1/10	

Ref. no.	Description	suitable for		€
32493	Insert Set (4 pieces)	32469	1/20	
32494	Insert Set (4 pieces)	32470	1/20	

Fetlock gaiter

- custom-adjustable protection for horses' legs and tendons
- special fetlock protection through exact shaping
- made from shock-absorbing, durable and breathable synthetic rubber – prevents injuries and wounds
- very easy to attach with hook and loop fasteners that stabilise and fix
- universally applicable for all disciplines
- 4-pce set



Ref. no.	Colour	Size	Front legs (H / W)	Real legs (H / W)		€
320131	black	Pony	27 cm / 24 cm	29 cm / 28,5 cm	1/25	
320132	black	Cob	29 cm / 28,5 cm	30 cm / 31 cm	1/25	
320133	black	Full	30 cm / 31 cm	31 cm / 33 cm	1/25	

Leg and hoof protection

Gaiters TecAir

- anatomically shaped, shock-absorbing leg protection
- soft, shock-absorbing and pressure-regulating padding for a secure fit
- maximum shock protection at minimal weight
- ventilation holes for more breathability
- with hook and loop fastener
- in pairs



Ref. no.	Colour	Size	Design		€
3211617	black	Cob	Synthetic rubber	1/20	
3210530	black	Full	Synthetic rubber	1/20	
3230474	navy	Cob	Synthetic rubber	1/20	NEW
3230475	navy	Full	Synthetic rubber	1/20	NEW

Fetlock Boots TecAir

- anatomically shaped, shock-absorbing leg protection
- soft, shock-absorbing and pressure-regulating padding for a secure fit
- maximum shock protection at minimal weight
- ventilation holes for more breathability
- with hook and loop fastener
- in pairs



Ref. no.	Colour	Size	Design		€
3230476	navy	Cob	Synthetic rubber	1/20	NEW
3230477	navy	Full	Synthetic rubber	1/20	NEW
3297671	black	Cob	Synthetic rubber	1/20	
3297669	black	Full	Synthetic rubber	1/20	

Dressage Gaiters Fleece

- ideal protection for horse legs and tendons with increased wearing comfort thanks to cuddly fleece
- made from durable synthetic leather
- with wide hook and loop straps for secure fit and for variable size setting
- in pairs



Ref. no.	Colour	Size	Design	Front legs (H / W)	Real legs (H / W)		€
3210545	black	Cob	front	26,5 cm / 28 cm		1/40	
3210546	black	Cob	back		30,5 cm / 32 cm	1/40	
3210549	black	Full	front	30,5 cm / 32 cm		1/40	
3210550	black	Full	back		33 cm / 33 cm	1/40	
3210547	brown	Cob	front	26,5 cm / 28 cm		1/40	
3210548	brown	Cob	back		30,5 cm / 32 cm	1/40	
3210551	brown	Full	front	30,5 cm / 32 cm		1/40	
3210552	brown	Full	back		33 cm / 33 cm	1/40	

Soft gaiters Avina

- especially lightweight and breathable thanks to mesh inserts
- Inside lined with hard-wearing faux leather
- anatomically adapted shape to protect horse legs
- with hook-and-loop fastener (sizes S, M two hook-and-loop fasteners, sizes L, XL three hook-and-loop fasteners)
- in pairs

New product 

Ref. no.	Colour	Size		€
3230490	black	Pony	1/30	
3230491	black	Cob	1/30	
3230492	black	Full	1/30	
3230493	black	XFull	1/30	
3230494	navy	Pony	1/30	
3230495	navy	Cob	1/30	
3230496	navy	Full	1/30	
3230497	navy	XFull	1/30	
3230498	white	Pony	1/30	
3230499	white	Cob	1/30	
3230500	white	Full	1/30	
3230501	white	XFull	1/30	



Soft gaiters Pelisa

- made from durable synthetic leather
- to protect horses' legs
- with hook-and-loop fastener (sizes S, M two hook-and-loop fasteners, sizes L, XL three hook-and-loop fasteners)
- soft inner faux fur lining
- anatomically adjusted shape
- in pairs

Ref. no.	Colour	Size		€
3226404	dark brown	Pony	1/20	
3226405	dark brown	Cob	1/20	
3226406	dark brown	Full	1/20	
3226407	dark brown	XFull	1/20	
3297637	black	Pony	1/20	
3297638	black	Cob	1/20	
3297639	black	Full	1/20	
3297640	black	XFull	1/20	
3297641	navy	Pony	1/20	
3297642	navy	Cob	1/20	
3297643	navy	Full	1/20	
3297644	navy	XFull	1/20	
3297645	white	Pony	1/20	
3297646	white	Cob	1/20	
3297647	white	Full	1/20	
3297648	white	XFull	1/20	



Leg and hoof protection

Bell boots Avina

- made from durable synthetic leather • shock-absorbing
- with hook and loop fastener for variable securing • in pairs

Ref. no.	Colour	Size		€
3230502	black	Pony	1/30	
3230503	black	Cob	1/30	
3230504	black	Full	1/30	
3230505	black	XFull	1/30	
3230506	navy	Pony	1/30	
3230507	navy	Cob	1/30	
3230508	navy	Full	1/30	
3230509	navy	XFull	1/30	
3230510	white	Pony	1/30	
3230511	white	Cob	1/30	
3230512	white	Full	1/30	
3230513	white	XFull	1/30	

New product

NEW



Bell boots NoTurn

- durable bell boots made from impact-resistant, dirt-repellent and sturdy material
- "no-turn" cut with interior fixings for excellent comfort • sturdy hook-and-loop fastener for optimum fit and protection • in pairs

Ref. no.	Colour	Size		€
3230514	black	Pony	1/20	
3230515	black	Cob	1/20	
3230516	black	Full	1/20	
3230517	black	XFull	1/20	

New product

NEW



Bell boots NeoLite

- made of durable, soft synthetic rubber • with double hook and loop fastener for variable securing • extra thick padding • in pairs

Ref. no.	Colour	Size		€
3230241	black	S	1/50	
3230242	black	M	1/50	
3230243	black	L	1/50	
3230244	black	XL	1/50	
3230245	dark navy	S	1/50	
3230246	dark navy	M	1/50	
3230247	dark navy	L	1/50	
3230248	dark navy	XL	1/50	
3230249	pink	S	1/50	
3230250	pink	M	1/50	
3230251	pink	L	1/50	
3230252	pink	XL	1/50	
3230253	blue	S	1/50	
3230254	blue	M	1/50	
3230255	blue	L	1/50	
3230256	blue	XL	1/50	
3230257	orange	S	1/50	
3230258	orange	M	1/50	
3230259	orange	L	1/50	
3230260	orange	XL	1/50	

New product

NEW



Bell boots Pelisa

- made from durable synthetic leather • shock-absorbing • with soft faux fur edging
- with hook and loop fastener for variable securing • in pairs

Ref. no.	Colour	Size		€
3226408	dark brown	Pony	1/20	
3226409	dark brown	Cob	1/20	
3226410	dark brown	Full	1/20	
3226411	dark brown	XFull	1/20	
3297649	black	Pony	1/20	
3297650	black	Cob	1/20	
3297651	black	Full	1/20	
3297652	black	XFull	1/20	
3297653	navy	Pony	1/20	
3297654	navy	Cob	1/20	
3297655	navy	Full	1/20	
3297656	navy	XFull	1/20	
3297657	white	Pony	1/20	
3297658	white	Cob	1/20	
3297659	white	Full	1/20	
3297660	white	XFull	1/20	



Bell boots Teddy Fleece

- durable bell boots made from impact-resistant, dirt-repellent and sturdy material
- "no-turn" cut with interior fixings for excellent comfort
- soft trim made from faux fur and sturdy hook and loop fastener for the best fit and protection
- in pairs

Ref. no.	Colour	Size		€
3222161	black	Pony	1/20	
3222162	black	Cob	1/20	
3222163	black	Full	1/20	
3222164	black	XFull	1/20	



Bell Boots Rubber

- made from soft rubber material • with simple hook-and-loop fastener • in pairs

Ref. no.	Colour	Size		€
3230261	blue	Pony	1/25	NEW
3230262	blue	Cob	1/25	NEW
3230263	blue	Full	1/25	NEW
3230264	blue	XFull	1/25	NEW
3230265	blue	XXFull	1/25	NEW
3230266	orange	Pony	1/25	NEW
3230267	orange	Cob	1/25	NEW
3230268	orange	Full	1/25	NEW
3230269	orange	XFull	1/25	NEW
3230270	orange	XXFull	1/25	NEW
3230271	pink	Pony	1/25	NEW
3230272	pink	Cob	1/25	NEW
3230273	pink	Full	1/25	NEW
3230274	pink	XFull	1/25	NEW
3230275	pink	XXFull	1/25	NEW
325843	black	Pony	1/25	
325844	black	Cob	1/25	
325845	black	Full	1/25	
3211614	black	XFull	1/25	
3226285	black	XXFull	1/25	



Leg and hoof protection

hoof boots rubber with teddy fleece

- made from soft rubber material • stable, double hook and loop fastener • with soft faux fur edging • in pairs



Ref. no.	Colour	Size		€
3224663	black	Pony	1/25	
3224664	black	Cob	1/25	
3224665	black	Full	1/25	
3224666	black	XFull	1/25	
3226286	black	XXFull	1/25	

Cooling gaiters

- flexible bandage with soft gel inserts for cooling muscles, tendons and joints • four hook-and-loop fasteners for ideal adaptation to the horse's leg • extremely durable and easy-care outer material • the special design ensures a long-lasting cooling effect
- Recommended period of use: 20 - 30 min after training to prevent injuries or for acute use • in pairs



Ref. no.	Colour	Size		€
3226435	black	onesize	1/10	

Bell boots Protecto

- durable, easy-clean outer material • inner lining made from soft, shock-absorbing synthetic rubber • stable, double hook and loop fastener • in pairs

Ref. no.	Colour	Size		€
3222158	black	Shetty	1/50	
320134	black	Pony	1/50	
320135	black	Cob	1/50	
320136	black	Full	1/50	
3211613	black	XFull	1/50	
3222159	black	XXFull	1/50	
3222160	black	XXXFull	1/50	



Hoof Shoe

- easily attached hoof shoe with variable hook and loop closures • the hoof is completely enclosed and optimally maintained • soft padding to the coronet band for good comfort without chafing • extremely tear-resistant polyamide material • anatomically shaped • non-slip sole made from plastic (TPU) resistant to wear and abrasion • per piece



Ref. no.	Size		€	Size	Hoof width	Hoof length
3222168	0	1/20		0	98 - 104 mm	104 - 109 mm
3222169	1	1/20		1	105 - 109 mm	110 - 114 mm
3222170	2	1/20		2	110 - 114 mm	115 - 119 mm
3222171	3	1/20		3	115 - 119 mm	120 - 124 mm
3222172	4	1/20		4	120 - 124 mm	125 - 129 mm
3222173	5	1/20		5	125 - 129 mm	130 - 134 mm
3222174	6	1/20		6	130 - 134 mm	135 - 139 mm
3222175	7	1/20		7	135 - 139 mm	140 - 144 mm
3222176	8	1/20		8	140 - 144 mm	145 - 149 mm
3222177	9	1/20		9	145 - 149 mm	150 - 154 mm
3222178	10	1/20		10	150 - 155 mm	155 - 160 mm

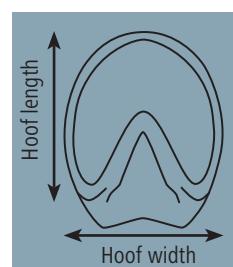

Fleece Bandage Empara

- with subtle glitter appliqués
- protects muscles and tendons
- can prevent injuries
- attaches securely and quickly thanks to a hook and loop fastener
- moisture and temperature balancing
- machine washable at 30 °C



Ref. no.	Colour	Length	Width	MOQ	Pieces / unit		€
3297776	black	300 cm	12 cm	1 pack	4 / pack	1/30	
3297777	navy	300 cm	12 cm	1 pack	4 / pack	1/30	
3297778	white	300 cm	12 cm	1 pack	4 / pack	1/30	

Transport and stall bandage

- soft and flexible bandage made of knitted material
- protects muscles and tendons
- can prevent injuries
- attaches securely and quickly thanks to a hook and loop fastener
- moisture and temperature balancing
- machine washable at 30 °C



Ref. no.	Colour	Length	Width	MOQ	Pieces / unit		€
3223982	white	350 cm	12 cm	1 pack	4 / pack	1/25	
3223983	black	350 cm	12 cm	1 pack	4 / pack	1/25	
3223984	navy	350 cm	12 cm	1 pack	4 / pack	1/25	

Bandage Pads

- generous, softly padded bandage linings
- breathable and skin-friendly material
- to protect horses' legs
- can be used multiple times
- in pairs
- machine washable at 30 °C



Ref. no.	Colour	Length	Width		€
3297668	black	65 cm	52 cm	1/10	

Bandaging underlay

- to protect horses' legs
- soft material with airy foam filling
- can be used multiple times
- machine washable at 30 °C
- in pairs

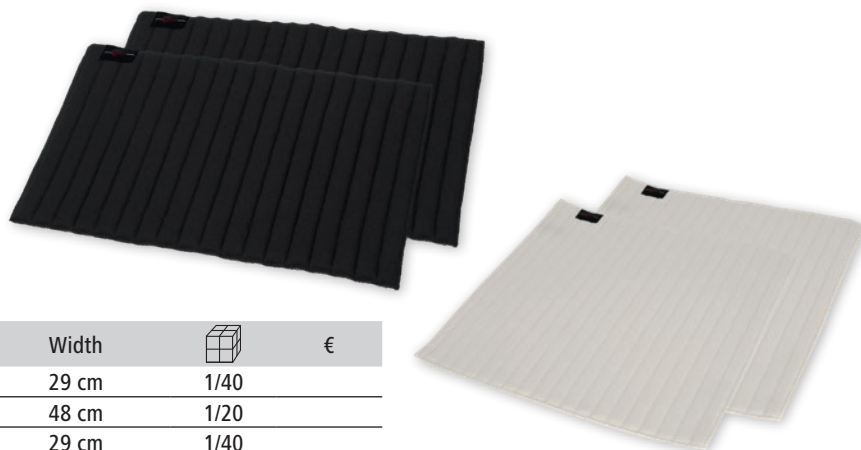

Ref. no.	Colour	Length	Width		€
32408	black	45 cm	29 cm	1/40	
32409	black	49 cm	48 cm	1/20	
3297661	white	45 cm	29 cm	1/40	
3297662	white	49 cm	48 cm	1/20	

CovallieroTherm - Textile horse products with infra-red therapy effect thanks to integrated ceramic particles

CovallieroTherm textiles, thanks to their embedded ceramic particles, have the ability to absorb solar energy (infra-red light) and body heat and store it. The energy absorbed by the textile is then returned to the body with infra-red radiation.

Infra-red rays pass through the skin barrier and penetrate deep into the tissue, and therefore into the muscles and blood vessels. As a result, CovallieroTherm products can help promote blood circulation, cell vitalisation and muscle relaxation in horses.

CovallieroTherm products are breathable, prevent the build-up of heat under the textile layer and ensure excellent sweat and moisture regulation.

The passive physiotherapy effect of CovallieroTherm textiles means that the horse needs to get used to wearing them initially. We recommend observing the horse while it is wearing CovallieroTherm products and adjusting the duration of use accordingly.

While using CovallieroTherm products, no perfusion-enhancing or warming agents should be used since these can lead to over-reactions.

We recommend the following usage times:



Week 1: max. 1 hour / day



Week 2: max. 3 hours / day



From week 3: max. 6 hours / day

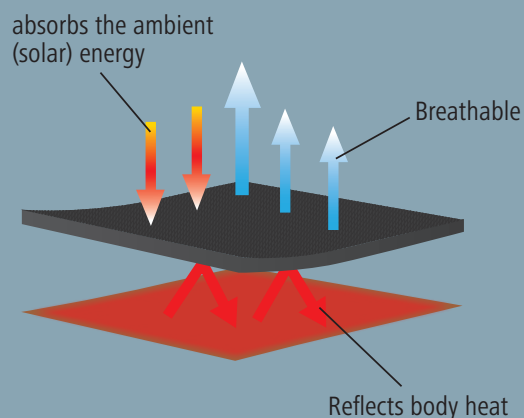

Gaiters Covalliero Therm

- sturdy hard shell in the entire tendon and fetlock head area • equipped with innovative CovallieroTherm material on the inside, which can increase the horse's well-being thanks to the built-in ceramic particles • fully upholstered on the exterior with mesh material for maximum air circulation to protect against overheating
- four elasticated suits with button fastening for easy attachment • customised adjustment thanks to three width settings • in pairs

New product

NEW

available from: March 2025

Ref. no.	Colour	Size		€
3230478	black	Pony	1/20	
3230479	black	Cob	1/20	
3230480	black	Full	1/20	
3230481	black	XFull	1/20	
3230482	navy	Pony	1/20	
3230483	navy	Cob	1/20	
3230484	navy	Full	1/20	
3230485	navy	XFull	1/20	
3230486	white	Pony	1/20	
3230487	white	Cob	1/20	
3230488	white	Full	1/20	
3230489	white	XFull	1/20	



Fleece blanket with neck piece Covalliero-Therm

- the innovative CovallieroTherm material with integrated ceramic particles can increase the horse's well-being • high-necked fleece blanket with neck piece • Breathable and fast-drying • double chest buckle with pin buckles • with tail strap
- adjustable surcingle • machine washable at 30 °C

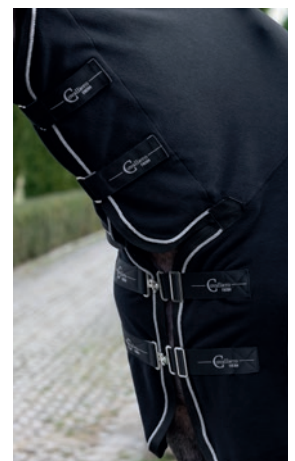

Ref. no.	Colour	Back length	Total length		€
3228251	black	115 cm	165 cm	1/5	
3228252	black	125 cm	175 cm	1/5	
3228253	black	135 cm	185 cm	1/5	
3228254	black	145 cm	195 cm	1/5	
3228255	black	155 cm	205 cm	1/5	

Fleece Bandage CovallieroTherm

- the innovative CovallieroTherm material with integrated ceramic particles can increase the horse's well-being
- breathable and skin-friendly material
- moisture and temperature balancing
- attaches securely and quickly thanks to a hook and loop fastener
- fleece fabric made of 100 % polyester fibres with thermally incorporated ceramic particles
- machine washable at 30 °C



Ref. no.	Colour	Length	Width	MOQ	Pieces / unit		€
3228245	black	3,5 m	10 cm	1 pack	4 / pack	1/25	

Bandaging underlay CovallieroTherm

- the innovative CovallieroTherm material with integrated ceramic particles can increase the horse's well-being
- breathable and skin-friendly material
- with hook-and-loop fastener for easy handling
- to protect horses' legs
- can be used multiple times
- soft material with airy foam filling
- in pairs
- machine washable at 30 °C



Ref. no.	Colour	Length	Width	Height		€
3228246	black	45 cm	30 cm	2 cm	1/25	
3228247	black	49 cm	48 cm	2 cm	1/20	

Stable gaiter CovallieroTherm

- the innovative CovallieroTherm material with integrated ceramic particles can increase the horse's well-being
- breathable and skin-friendly material
- easy to put on thanks to four hook-and-loop fasteners
- removable, soft inlay cushion with generous filling
- in pairs
- machine washable at 30 °C

Ref. no.	Colour	Size		€
3228248	black	Pony	1/24	
3228249	black	Cob	1/22	
3228250	black	Full	1/20	



Saddle Pad CovallieroTherm

- the innovative CovallieroTherm material with integrated ceramic particles can increase the horse's well-being
- breathable and skin-friendly material
- anatomically shaped with small-chequered quilting
- high-quality foam and polyester filling for optimum pressure balance
- durable upper material
- saddle and belt loops with hook and loop fastener
- Mesh insert along the spine for increased breathability
- machine washable at 30 °C





Ref. no.	Saddle pad shape	Colour		€
3228243	General purpose	black	1/20	
3228244	Dressage	black	1/10	

Coat Gloss Spray Foxfire

Intense care and radiant shine FOXFIRE - the premium care and fur gloss spray with its new improved formula now provides even better care and is even gentler on skin and fur. FOXFIRE also gives a perfect, long-lasting shine. Organic quality Argan oil, keratin and biotin improve hair quality in the long term - make it thicker, stronger and smoother.



with provitamin D-panthenol.



Ref. no.	Contents			€
3223425	500 ml / Spray bottle	1/6	360	
32520	1000 ml / Spray bottle	1/6	384	
32521	5000 ml / Canister	1/4	128	

Horse shampoo DERMOCAN

- penetrates deeply into the skin, dissolves dirt and sweat and maintains fur and skin
- provides a beautiful, glossy look thanks to ingredients specially tailored to horse coats
- causes gradual reactivation for healthy hair growth



with natural cold-pressed grape seed oil

Ref. no.	Contents			€
32525	500 ml / Bottle	12	600	
32526	1000 ml / Bottle	1/6	384	

Massage Ointment Refreshing

- promotes blood flow to the muscles
- cooling and relaxing massage balm gel
- has a refreshing and invigorating effect on legs, back, chest and saddle area



Ref. no.	Contents			€
32530	500 ml / Can	1/6	726	

Clay Gel

Paste with mineral-containing alumina and arnica for tendons, ligaments, muscles and joints.

- the natural active ingredients mobilise, activate and regenerate, penetrating deeply
- promotes the regeneration process after strains, pulled muscles, bruising etc.
- metabolic products that lead to sore muscles are removed quickly

for tendons, ligaments, muscles and joints

Ref. no.	Contents			€
15593	2 kg / Can	1/6	240	





simply bright!



The World of MagicBrush.

MagicBrush Horse Care: High-quality and consistent further development ensure innovative care products at the highest level.



MagicBrush Horse salt shower starter kit

Improve your horse's wellbeing with the MagicBrush Horse Salt Shower. The natural sea salt sticks lock moisture and excess oil into the skin and can help irritated skin to recover naturally.

- easy-to-use shower insert for the garden hose
- Sea salt sticks contain valuable minerals that can have a positive effect on the skin's natural function and protective barrier
- Sea salt promotes the regeneration of irritated, red and itchy skin in horses
- the minerals it contains lock moisture and excess oil into the skin, which allows the appearance of the skin to improve visibly
- applied over a prolonged period, the horse salt shower can suppress the after-effects of skin irritation (e.g. chafing)
- suitable for a max. water pressure of 4 bar

Set consisting of: 1 x horse salt shower cartridge incl. hose coupling, 14 x salt sticks, 1 x hose connection reducer from 3/4" to 1/2"

Ref. no.		€
3229060	1/35	

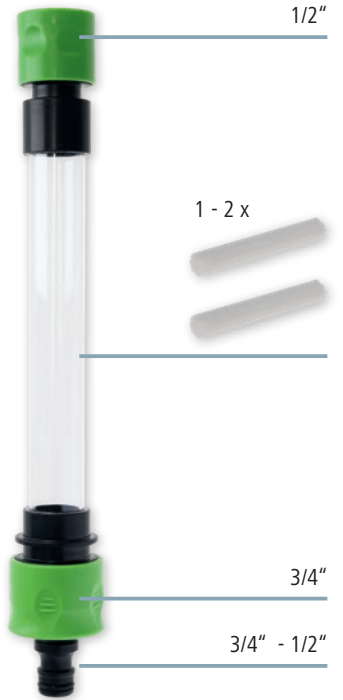

Ref. no.	Description	Material	MOQ	Pieces / unit		€
3229069	MagicBrush Salt sticks		1 pack	14 / pack	1/36	NEW
3229061	MagicBrush Salt sticks		1 pack	30 / pack	1/20	
3229063	Hose Coupling 3/4" - 1/2"	Plastic			1/50	

MagicBrush Skin Care Balm SkinCare

The new balm can help stressed and itchy skin caused by a wide variety of environmental factors. The special formula absorbs quickly, is non-greasy and provides long-lasting, intense care!

- balm for stressed horse skin
- special fast-absorbing formula takes the high-quality ingredients instantly to the stressed skin layers
- natural extracts of calendula, carrot and St. John's wort provide increased resistance for the skin and coat
- fluid sulphur is known to reduce itching and consequently the tendency to rub
- the vegetable oil mixture in the formula embedded in a balm complex, non-greasy and provides long-lasting, intense care

How to use: Shake well before use. Apply thinly once or twice a day and massage in.

with marigold, carrot and St. John's Wort oil

Ref. no.	Contents			€
3223375	500 ml / Bottle	1/12	648	
3223376	2000 ml / Canister	1/4	192	



Made in the EU



MagicBrush Coat Gloss Spray ManeCare Premium

Treat your horse to some luxury with the ManeCare Premium Edition!

There's a new and premium addition to the well-known ManeCare coat shine spray range that combines exceptional shine, scent, care and performance in one.



- extraordinary fragrance mixtures paired with maximum effect on the coat and long hair
- protects the coat and makes the long hair very easy to comb
- does not stick and leaves a stunning gloss
- prevents skin and coat problems caused by UV rays

OrientalNights: makes the coat soft and silky with special essential proteins.

FrenchKiss: aromatic plant and herbal extracts from e.g. lavender and thyme, protect and maintain. The special formula can prevent dandruff and fur loss.

FruitExplosion: moisturising and revitalising ingredients such as raspberry, apple, cucumber or papaya extracts ensure a glossy, healthy coat. A soothing treatment for damaged hair.



Ref. no.	Description	Contents			€
3223427	OrientalNights	500 ml / Spray bottle	1/12	648	
3223428	FrenchKiss	500 ml / Spray bottle	1/12	648	
3223429	FruitExplosion	500 ml / Spray bottle	1/12	648	



Made in the EU



MagicBrush Coat Gloss Spray ManeCare

- a moisturising agent (D-Panthenol complex) protects the skin and coat from drying out – D-Panthenol also soothes damaged skin
- contains a special care compound which improves wet and dry combing of the hair - thus preventing fracture and felting when brushing and combing
- makes combing and grooming of mane and tail hair easier
- glossy coat spray and long hair conditioner in one
- with pleasant smell
- with rich almond oil to care for the horse's coat
- gives the coat a silky, glossy appearance for many hours

with almond oil and D-Panthenol

Ref. no.	Contents			€
3223443	1000 ml / Spray bottle	1/6	432	
3223444	5000 ml / Canister	1/2	112	

Ref. no.	Description		€
15564	Dispensing Pump for Canister	1/200	



Top Seller



Made in the EU



MagicBrush Cleaning Lotion EasyCare

- spray on, leave for a short time to take effect then wipe off with a dry cloth - finished!
- contains D-panthenol – protects skin and coat from drying out
- special formulation for gentle yet thorough cleaning of the horse's coat without water
- for cleaning in between times or before tournaments
- also specially recommended for light coat colours

with D-Panthenol

Ref. no.	Contents			€
3223441	500 ml / Spray bottle	1/12	648	



Made in the EU



MagicBrush Cooling Gel EquiMint

Excellent cooling and refreshing gel for horse and rider with menthol and peppermint oil to optimally support rapid regeneration of muscles, tendons and joints with circulation-promoting properties.

- recommended for horse and rider
- promotes blood circulation in the muscles and contributes to faster regeneration
- with menthol and peppermint oil, cools and refreshes tired horses' legs, tendons, joints and muscles
- rapidly absorbed and leaves no residue on the coat
- ADMR 48 hours



New product 

with menthol and peppermint oil

Ref. no.	Contents			€
3230518	500 ml / Can	1/12	648	

Made in the EU



MagicBrush Cooling Balsam Equifresh

- recommended for horse and rider
- cools and refreshes tired horses' legs, tendons, joints and muscles
- applied immediately after training or riding
- rapidly absorbed and leaves no residue on the coat



with arnica, menthol, ginkgo and chamomile

Ref. no.	Contents			€
3223440	500 ml / Pump Bottle	1/12	648	

Made in the EU



MagicBrush Lip balm for horses Lucky Lips

Lip Balm Lucky Lips is a special care product that is used to care for the sensitive skin around the horse's mouth. It is used to prevent dryness and cracks that can be caused by the friction of bits. Lip Balm Lucky Lips contains nourishing ingredients such as calendula, mango butter and Vaseline to keep the skin supple and moisturised. It is particularly helpful for horses that are sensitive to bits and promotes the animal's well-being while riding.

- protects and cares for the sensitive skin in the mouth area and the corners of the mouth
- prevents dryness and cracks caused by bits and promotes lubrication in the mouth
- contains nourishing calendula extract
- promotes the well-being of the horse while riding
- with delicious apple flavour for better acceptance
- doping-free



Made in the EU



New product 

Ref. no.	Contents		€
3230519	150 ml / Can	1/12	

MagicBrush Horse shampoo with wheat proteins

Gentle horse shampoo made from high-quality ingredients for the care and maintenance of the mane, tail and coat. Contains wheat proteins for silky shine, easy combing and intact, healthy skin! The skin is supplemented with important nutrients and remains flexible and resilient. Regular use preserves the natural structure and shine of the coat.

- deep yet gentle cleaning for a soft and shiny coat
- a moisturising agent (D-Panthenol complex) protects the skin and coat from drying out – D-Panthenol also soothes damaged skin
- skin protection formulation, even with frequent washing



Made in the EU



with oat proteins and D-Panthenol

Ref. no.	Contents			€
3223442	1000 ml / Bottle	1/6	432	

MagicBrush Shampoo

This selection of extra mild horse shampoos cares for the coat, mane and tail in a natural way. Each shampoo is specially tailored to different needs and ensures a shiny and supple coat. Whether for sensitive skin, intense shine or additional moisture - the shampoos offer mild cleansing without irritating additives. The result is a healthy, radiant coat, supported by the power of natural ingredients.

- made from 100 % natural ingredients, without aggressive chemicals
- ideal for sensitive horse skin
- can soothe skin irritations
- gives intense shine and protects against drying out
- skin-friendly formulations that are adapted to the pH value of the horse's skin

OrientalNights: with rice milk; provides intensive moisture, strengthens the mane, tail and coat with its natural proteins and gives shine and suppleness. It is particularly gentle on the horse's skin and is ideal for sensitive skin.

FrenchKiss: with herbal extracts; offers soothing and regenerating care for mane, tail and coat. Cannabis and field horsetail strengthen the coat and long hair and promote growth, calendula and camomile have a vitalising effect and herbal vinegar cleanses and gives shine.

FruitExplosion: with fruit and amaranth extract; intensively nourishes the mane, tail and coat and gives suppleness and a radiant shine. The fruity ingredients are rich in antioxidants and vitamins that revitalise the hair, while amaranth extract strengthens and protects it.



New product

NEW

Ref. no.	Description	Contents		€
3230520	OrientalNights	500 ml / Bottle	1/12	
3230521	FrenchKiss	500 ml / Bottle	1/12	
3230522	FruitExplosion	500 ml / Bottle	1/12	

Made in the EU



MagicBrush Brush Set Jellyfish

For a radiant, well-groomed coat and more colour in your grooming routine: The set consists of two classic MagicBrush brushes in the exclusive Jellyfish design and a soft brush for the sensitive areas on the head and neck. The special structure and shape of the Quadro bristle cleans particularly effectively and provides a pleasant massage effect.

- set of 3 MagicBrush brushes, one of which is a Softbrush
- with special bristles for efficient cleaning with massage effect
- suitable for the care of body, head, leg and hoof
- brush back can be used as a welding knife
- easy to clean in the washing machine

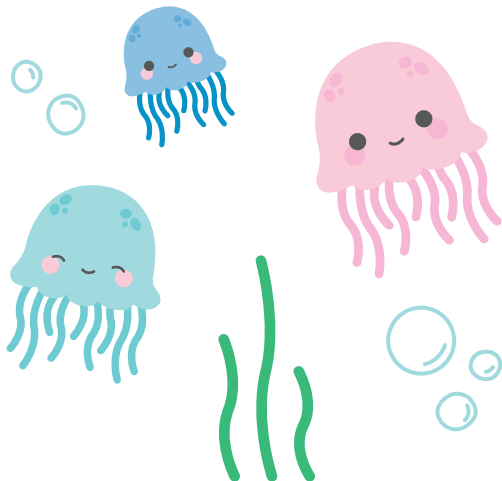

Made in the EU



Ref. no.	Colour		€
3228256	jellyfish	1/20	

MagicBrush Brush Set Classic

A real all-rounder: whether for coats, legs or hooves, for dry or wet cleaning, during coat changes or for cleaning saddle pads and blankets - the MagicBrush Classic is always the first brush of choice. Thanks to special structure and shape of the MagicBrush Quadro bristle, it cleans particularly effectively and at the same time has a pleasant massage effect.

- ergonomic brush shape fits perfectly in the hand
- suitable for the care of coat, leg and hoof
- hygienic: Brushes can be cleaned in the washing machine
- 2 in 1: the back of the brush can be used as a sweat scraper



Ref. no.	Colour		€
328313	classic	1/20	



Made in the EU





MagicBrush PINK PONY

PINK PONY is printed with the cheeky-sweet pink MagicBrush pony. PINK PONY does not just look good, it lets the horse and rider properly shine out. The special bristles massage while brushing - so the horses are really clean and feel comfortable all around. MagicBrush PINK PONY is also ideal used as a sweat knife and frees the saddle blanket from horse hairs. MagicBrush PINK PONY can if necessary go in the washing machine.

Ref. no.	Colour		€
328311	pink	1/80	



Made in the EU



MagicBrush Soft

MagicBrush Soft is the care and cuddling brush that is ideal for the particularly sensitive areas of horses and ponies, such as head and ears. Even highly sensitive horses and ponies enjoy care with the new MagicBrush Soft.

- the ultra-soft Quadro bristles clean particularly gently
- the gentle massage increases the horse's well-being
- gentle cleaning with a cuddly effect - for happy horses, ponies and riders

Ref. no.	Colour		€
3297683	white lily	1/80	
3297684	turquoise	1/80	



Made in the EU



MagicBrush Bag Unicorn

MagicBrush has expanded its collection with the practical Unicorn MagicBrush Bag – made from high quality cotton, certified to the STANDARD 100 by OEKO-TEX®. With the quality unicorn print in deep fuchsia, the new MagicBrush Bag Unicorn is a fashionable must-have for every young rider.

Ref. no.	Colour		€
329998	blue	1/200	



MagicBrush Brush Set CornFlowers

For more sustainability in the cleaning box: The MagicBrush Set Cornflowers in trendy shades is made from recycled PE. To do this, used plastic packaging is separated and ground into granules. This is the starter material for new plastic products - such as the MagicBrush Cornflowers Recycled. The MagicBrush Cornflowers is also very special in terms of colour: the white dots in the material make the brushes particularly appealing! The special structure and shape of the MagicBrush Quadro bristle cleans particularly effectively and provides a pleasant massage effect.

- Set of 3 MagicBrush brushes • made from recycled plastic • suitable for the care of coat, leg and hoof • hygienic: Brushes can be cleaned in the washing machine • 2 in 1: the back of the brush can be used as a sweat scraper



New product **NEW**

Made in the EU



Ref. no.	Colour		€
3230523	cornflowers	1/20	

MagicBrush Single brush Janne recycled

The MagicBrush Janne is made of recycled plastic and is suitable for cleaning fur, legs and hooves. The special structure and shape of the Quadro bristle cleans particularly effectively and provides a pleasant massage effect.

- suitable for the care of coat, legs and hooves • with special bristles for efficient cleaning with massage effect • brush back can be used as a welding knife • easy to clean in the washing machine • made from recycled plastic



Made in the EU



Ref. no.	Colour		€
3228257	grey	1/80	

MagicBrush Brush Nature

A shiny horse - but sustainable, please. This is possible with the new MagicBrush Nature made from sustainable plastic. The brush is made of 50 % renewable raw materials such as straw and sugar and is kind to the environment. As a new, medium-hard version of the popular MagicBrush, the Nature brush is the perfect complement to the classic MagicBrush and the Softbrush.

- made from sustainable plastic - at least 50 % from straw and sugar
- new, medium-hard version for light massage and lasting shine
- suitable for the care of coat, leg and hoof
- hygienic: Brushes can be cleaned in the washing machine
- 2 in 1: the back of the brush can be used as a sweat scraper



Made in the EU



Ref. no.	Colour		€
3224535	nature	1/80	

simply
bright!



MagicBrush Plastic Curry Comb WaterLily

• sustainably produced plastic: up to 60 % recycled material in the plastic (PP)
– additional use of rice and straw fibres up to 55 % • with hand loop made from 100 % cotton

Ref. no.	Length	Width		€
3297677	16 cm	11 cm	1/50/100	
3297678	13 cm	9 cm	1/50/100	



MagicBrush Mane brush WaterLily

• sustainably produced plastic: up to 60 % recycled material in the plastic (PP)
– additional use of rice and straw fibres up to 55 % • natural fibre bristles (leaf fibres of the Mexican agave)

Ref. no.	Length	Width		€
3297679	22 cm	6 cm	1/10/50	
3297680	18 cm	5 cm	1/20/100	



MagicBrush Horse Hair Finishing Brush WaterLily

• sustainably produced plastic: up to 60 % recycled material in the plastic (PP)
– additional use of rice and straw fibres up to 55 % • bristles made from 65 % natural horsehair and 35 % recycled synthetic fibres • with hand loop made from 100 % cotton

Ref. no.	Length	Width		€
3297681	17 cm	8 cm	1/10/50	
3297682	14 cm	7 cm	1/20/100	



MagicBrush Horse brush WaterLily

• sustainably produced plastic: up to 60 % recycled material in the plastic (PP)
– additional use of rice and straw fibres up to 55 % • with hand loop made from 100 % cotton • natural hog bristles

Ref. no.	Length	Width		€
3297780	17 cm	8 cm	1/10/50	
3297781	14 cm	7 cm	1/20/100	



MagicBrush Hoof pick WaterLily

• sustainably produced plastic: up to 60 % recycled material in the plastic (PP)
– additional use of rice and straw fibres up to 55 % • with metal scraper and cleaning brush • Bristle length: 3 cm

Ref. no.		€
3297782	1/100/200	

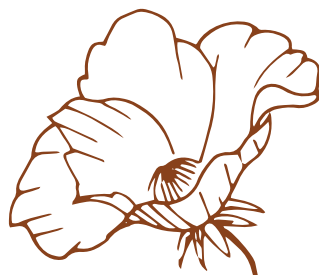

simply bright!



MagicBrush Mane and Tail Brush

The functional mane and tail brush for finely combed long hair.

- Natural wood brush with elasticated bristles for easy combing of long hair
- rounded bristle ends provide an additional massage effect • snarls are easy to untangle • rounded handle shape for a comfortable grip



New product

Ref. no.	Length	Width	Height		€
3230524	22 cm	10 cm	4 cm	1/50	



simply bright!



Made in Germany



MagicBrush Combi Horse Brush

The optimum horse brush with the 2in1 function: cleans and shines

- brush back made from beech wood treated with oil, with soft rounded lines • the special MagicBrush shape fits perfectly in your hand • combined bristle material for fast and effective cleaning with a gloss effect: the outer fibre head retrieves loose hair, dust and dirt from the coat – the horsehair head provides moisture and perfect shine • the flexible bristles penetrate deep into the coat and ensure an extraordinary result



Ref. no.		€
3297787	1/20	



simply
bright!



Made in Germany



MagicBrush Cleaning Brush coarse

The natural coat cleaning brush for thorough (pre-) cleaning!

- brush back made from beech wood treated with oil, with soft rounded lines
- the special MagicBrush shape fits perfectly in your hand
- the Arenga head is perfect for coarse dirt on legs, hooves and less sensitive areas of the body and cleans thoroughly without compromise
- the flexible bristles penetrate deep into the coat and ensure an extraordinary result



Ref. no.		€
3297788	1/20	

MagicBrush Cleaning Brush soft

The natural coat cleaning brush for sensitive contemporaries!

- brush back made from beech wood treated with oil, with soft rounded lines
- the special MagicBrush shape fits perfectly in your hand
- the fibre head retrieves loose hair, dust and dirt out of the coat and cleans gently yet thoroughly
- the flexible bristles penetrate deep into the coat and ensure an extraordinary result



Ref. no.	Bristle length		€
3297789	5 cm	1/20	
3229056	7 cm	1/20	

MagicBrush Horse Hair Finishing Brush

The natural horse brush ensures the ultimate shine effect.

- brush back made from beech wood treated with oil, with soft rounded lines
- the special MagicBrush shape fits perfectly in your hand
- the horsehair head provides moisture and perfect shine
- the flexible bristles penetrate deep into the coat and ensure an extraordinary result



Ref. no.		€
3297790	1/20	

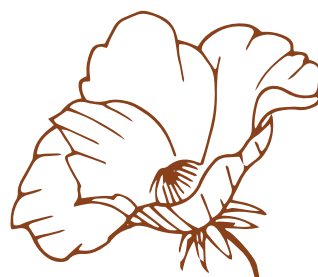

Plastic Curry Comb Lilli Starlight

- made of robust plastic • with polyamide hand strap

Ref. no.	Length	Width		€
3297663	13 cm	9 cm	1/40/200	



Mane brush Lilli Starlight

- back made from non-slip plastic • Bristle material: Polypropylene

Ref. no.	Length	Width	Bristle length		€
3297664	18 cm	5 cm	4 cm	1/10/100	



Horse Hair Finishing Brush Lilli Starlight

- back made from non-slip plastic • with wrist loop • Bristle material: Horse Hair

Ref. no.	Length	Width	Bristle length		€
3297665	14 cm	7 cm	3 cm	1/10/100	



Horse brush Lilli Starlight

- back made from non-slip plastic • with wrist loop
- Bristle material: Polypropylene

Ref. no.	Length	Width	Bristle length		€
3297666	14 cm	7 cm	3 cm	1/10/100	



Hoof pick Lilli Starlight

- made of robust plastic • with metal scraper and cleaning brush
- Bristle material: Polypropylene

Ref. no.		€
3297667	1/20/200	



Care Bag Lilli

- attractive sports bag filled with coat cleaning and care tools in a trendy design
- can also be used as a gym bag or rucksack
- with drawstring and reinforced corners
- Material: Polyester

Ref. no.	Length	Width		€
3210361	40 cm	35 cm	1/10	





Covalliero Plastic Curry Comb

• made of robust plastic • with polyamide hand strap

Ref. no.	Colour	Length	Width		€
3210350	black	16 cm	11 cm	1/20/100	



Covalliero Mane brush

• back made from non-slip plastic • Bristle material: Polypropylene

Ref. no.	Colour	Length	Width	Bristle length		€
3210351	black	22 cm	6 cm	4 cm	1/10/50	



Covalliero Horse Hair Finishing Brush

• back made from non-slip plastic • with wrist loop • Bristle material: Horse Hair

Ref. no.	Colour	Length	Width	Bristle length		€
3210352	black	17 cm	8 cm	3 cm	1/10/50	



Covalliero Horse brush

• back made from non-slip plastic • with wrist loop • Bristle material: Polypropylene

Ref. no.	Colour	Length	Width	Bristle length		€
3210353	black	17 cm	8 cm	3 cm	1/10/50	



Covalliero Hoof pick

• made of robust plastic • with metal scraper and cleaning brush • Bristle material: Polypropylene

Ref. no.	Colour		€
3210354	black	1/5/20/100	



Covalliero Care Bag

• attractive sports bag filled with coat cleaning and care tools in a trendy design
• 100 % polyester

Included in delivery: 1 x care bag, 1 x plastic curry comb, 1 x mane brush, 1 x horse brush, 1 x hoof pick

Ref. no.	Colour	Length	Width		€
3210362	red	45 cm	40 cm	1/10	



Horse brush

- Painted wood back • with wrist loop • Bristle material: Polypropylene



Ref. no.	Colour	Length	Width		€
3243	nature	22 cm	9 cm	1/10/60	
321313	nature	17 cm	6,5 cm	1/10/100	

Grooming Brush

- ideal for grooming and pampering your horse • soft horsehair bristles make the coat especially glossy and promote natural oil replenishment • oval shape with wooden handle • Bristle material: Horse Hair



Ref. no.	Colour	Length	Width		€
321623	nature	13 cm	9,5 cm	1/10/100	

Horse brush

- very soft, fine goat hair makes the coat especially glossy • very good price/performance ratio
- wooden back • with integrated hand strap



321649
the ideal size for
children's hands

Ref. no.	Colour	Length	Width		€
321649	nature	14 cm	6 cm	1/10/100	
321648	nature	16,5 cm	8,5 cm	1/10/100	

Mane brush Standard

- with synthetic bristles on painted wood back
- Bristle material: Polypropylene



Ref. no.	Colour	Length		€
3215	nature	16 cm	1/10/100	

Covalliero Mane brush 2K

- soft handle with non-slip material made from plastic • ergonomic handle shape
- with flexible plastic bristles for optimum brushability



New product NEW

Ref. no.	Colour	Length	Width	Height		€
3230283	brown / black	24 cm	7 cm	5,5 cm	1/50	

Covalliero Brush 2K

- soft handle with non-slip material made from plastic • convenient size • with bristles made from polypropylene, polyethylene



New product NEW

Ref. no.	Colour	Length	Width	Height		€
3230277	brown / black	17 cm	6 cm	6,5 cm	1/50	
3230278	brown / black	20,7 cm	6,4 cm	7 cm	1/50	

Covalliero Flex HorseHair 2K

- extremely easy to use thanks to the bi-flexible back made from plastic
- anatomically adapted for increased cleaning effect • especially high-grip surface with anti-slip inserts • ideally adjustable strap made from nylon • with horsehair bristles



New product NEW

Ref. no.	Colour	Length	Width	Height		€
3230279	brown / black	18,5 cm	9,3 cm	4,1 cm	1/50	

Covalliero Flex NatureBristles 2K

- extremely easy to use thanks to the bi-flexible back made from plastic • anatomically adapted for increased cleaning effect • especially high-grip surface with anti-slip inserts • ideally adjustable strap made from nylon • with natural fibre bristles (leaf fibres of the Mexican agave)



New product NEW

Ref. no.	Colour	Length	Width	Height		€
3230280	brown / black	18,5 cm	9,3 cm	4 cm	1/50	

Covalliero Nubbed Curry Comb Flex 2K

- extremely easy to use thanks to the bi-flexible back made from plastic
- anatomically adapted for increased cleaning effect
- especially high-grip surface with anti-slip inserts
- ideally adjustable strap made from nylon
- can be used for cleaning or as a massage brush
- anatomically designed nubs for an exceptional massage effect (plastic nubs)



New product **NEW**

Ref. no.	Colour	Length	Width	Height		€
3230281	brown / black	18,5 cm	9,3 cm	2,7 cm	1/50	

Covalliero Curry comb Flex 2K

- extremely easy to use thanks to the bi-flexible back made from plastic
- anatomically designed nubs for increased cleaning effect (made of plastic)
- especially high-grip surface with anti-slip inserts
- ideally adjustable strap made from nylon



New product **NEW**

Ref. no.	Colour	Length	Width	Height		€
3230282	brown / black	18,5 cm	9,3 cm	2,5 cm	1/50	

Covalliero Spiral Curry Comb 2K

- soft handle with non-slip material made from plastic
- ergonomic handle shape
- finely toothed and flexible spring steel
- can be used on both sides



New product **NEW**

Ref. no.	Colour	Length	Width	Height		€
3230276	brown / black	26 cm	11 cm	5,2 cm	1/50	

Covalliero Sweat Scraper 2K

- soft handle with non-slip material made from plastic
- ergonomic handle shape
- rounded form with flexible rubber lip



New product **NEW**

Ref. no.	Colour	Length	Width	Height		€
3230284	brown / black	19 cm	21,5 cm	4,3 cm	1/50	

Covalliero Hoof pick 2K

- soft handle with non-slip material made from plastic
- ergonomic handle shape
- with metal scraper and cleaning brush made from polypropylene and polyethylene



New product **NEW**

Ref. no.	Colour	Length	Width	Height		€
3230285	brown / black	17 cm	9 cm	2,4 cm	1/100	

Covalliero Mane brush Deluxe

- sits comfortably in the hand thanks to faux leather insert on the handle
- with flexible bristles for optimum brushability • polypropylene material
- hanger on handle

New product **NEW**



Ref. no.	Colour	Length	Width	Height		€
3230287	brown / black	24,5 cm	7,5 cm	5,5 cm	1/50	

Covalliero Curry Comb Deluxe

- sits comfortably in the hand thanks to faux leather insert • Plastic rim
- polypropylene bristle material • with elegant appliqué logo • with nylon retaining strap
- With hanger

New product **NEW**



Ref. no.	Colour	Length	Width	Height		€
3230288	brown / black	18,5 cm	9,3 cm	5,5 cm	1/50	

Covalliero Curry comb Deluxe

- sits comfortably in the hand thanks to faux leather insert • with elegant appliqué logo • with nylon retaining strap • With hanger

New product **NEW**



Ref. no.	Colour	Length	Width	Height		€
3230289	brown / black	16,3 cm	10,5 cm	2 cm	1/100	

Covalliero Scrubbing Brush Deluxe

- sits comfortably in the hand thanks to faux leather insert • polypropylene bristle material • with elegant appliqué logo • with rubber edge for good hold
- With hanger

New product **NEW**



Ref. no.	Colour	Length	Width	Height		€
3230290	brown / black	18 cm	5,8 cm	6,8 cm	1/50	

Covalliero Mini Deluxe

- sits comfortably in the hand thanks to faux leather insert • polypropylene bristle material • with elegant appliqué logo • with rubber edge for good hold
- With hanger

New product **NEW**



Ref. no.	Colour	Length	Width	Height		€
3230291	brown / black	13 cm	4 cm	4,5 cm	1/100	

Covalliero Spiral Curry Comb Deluxe

- sits comfortably in the hand thanks to faux leather insert on the handle • finely toothed and flexible material made from spring steel
- with elegant appliqué logo • can be used on both sides • hanger on handle

New product **NEW**



Ref. no.	Colour	Length	Width	Height		€
3230286	brown / black	26,5 cm	10,5 cm	4,7 cm	1/50	

Covalliero Sweat Scraper Deluxe

- sits comfortably in the hand thanks to faux leather insert on the handle
- rounded form with flexible rubber lip • with elegant appliqué logo
- hanger on handle

New product **NEW**



Ref. no.	Colour	Length	Width	Height		€
3230292	brown / black	19 cm	21,5 cm	4,3 cm	1/50	

Covalliero Hoof pick Deluxe

- sits comfortably in the hand thanks to faux leather insert on the handle • with metal scraper and cleaning brush made from polypropylene and polyethylene
- with elegant appliqué logo • hanger on handle

New product **NEW**



Ref. no.	Colour	Length	Width	Height		€
3230293	brown / black	18,5 cm	9 cm	3,2 cm	1/200	

Horse brush MiniDolly

- synthetic bristles • with elastic hand loop



Ref. no.	Colour	Length	Width		€
3265	assorted colours	15 cm	7,5 cm	1/104	

Cuddle brush for horses

- one grooming brush with a nice shape and in happy colours • with soft bristles gives coats a silky shine
- with elastic hand loop



New product

NEW

Ref. no.	Colour	Length	Width		€
3230543	assorted colours	14 cm	6,5 cm	1/108	

Horse brush Junior

- enables intensive fur care • excellent shape and handling • with leather wrist strap
- Bristle material: Pastic Fibre and Horse Hair



Ref. no.	Colour	Length	Width		€
3242	nature	20 cm	8,5 cm	1/60	

Mane Brush small

- with plastic back • top mane and washing brush
- Bristle material: Polyamide



Ref. no.	Colour	Length	Width	Bristle length		€
3213	assorted colours	18 cm	5,3 cm	3 cm	1/100	

Double Brush Putzi

- with handle and two sides • Nub side with massage effect ensures good blood circulation



Ref. no.	Colour		€
321304	assorted colours	1/96	

Coat and Mane Brush Wurzel

- sturdy scrubbing brush made from colourful synthetic material
- with polyamide hand strap



Ref. no.	Colour	Length	Width		€
321306	assorted colours	20 cm	8,5 cm	1/50	

Coat and Mane Brush Kinder-Wurzel

- synthetic edging for intensive coat cleaning
- with elastic hand loop



Ref. no.	Colour	Length	Width		€
321307	assorted colours	15 cm	7,5 cm	1/88	

Horse brush Groovy

- with soft nylon bristles for gentle yet effective grooming
- with elastic hand loop



Ref. no.	Colour	Length	Width	Bristle length		€
321308	assorted colours	17 cm	9 cm	5 cm	1/45	

Curry comb New Generation

- made from soft, elastic specialist plastic for particularly beneficial massage
- with polyamide hand strap

Ref. no.	Colour	Length	Width		€
321310	assorted colours	16 cm	10 cm	1/100	



Curry comb Der Gute

- made from tough specialist plastic
- elastic with particular curry comb effect

Ref. no.	Colour	Length	Width		€
321302	assorted colours	16 cm	10 cm	1/100	





Lambskin Brush Diva

The gentle shine brush with lambskin and mixed-bristle rim ensures a well-groomed, shiny coat and gives the perfect finish to horse grooming.

- with lambskin pad and soft rim made from mixed bristles
- for a cared-for, shiny coat
- with practical hand strap
- Material: Plastic

Diva Mini: with elastic hand loop

Diva: with fabric loop

Ref. no.	Colour	Length	Width		€
328271	blue	17 cm	9 cm	1/60	
328270	blue	20 cm	8,5 cm	1/54	



328271



328270



Rubber Nub Curry Comb

- ideal for massaging horses or for changing their coat
- with rounded back and practical handle for optimum grip
- Material: Plastic

Ref. no.	Colour	Ø		€
3230537	black	12,5 cm	1/100	
3230538	blue	12,5 cm	1/100	
3230539	red	12,5 cm	1/100	



New product

NEW

Magnetic Massage Curry Comb

- for beneficial massage
- with seven magnetic massage balls and rubber bobbles
- made from soft plastic
- can be used on both sides

Ref. no.	Colour		€
320138	royal blue	1/50/100	
320139	purple	1/50/100	
320140	pink	1/50/100	



Rubber Curry Comb Oval

- with wrist loop

32820, 32821: the ideal size for children's hands

Ref. no.	Colour	Length	Width		€
32821	black	13,5 cm	9 cm	1/100	
32820	red	13,5 cm	9 cm	1/100	
3210	black	15 cm	10,5 cm	1/10/100	
3217	red	15 cm	10,5 cm	1/10/100	



Rubber Nub Curry Comb

- for beneficial massage
- ideal for shedding
- with integrated hand strap

Ref. no.	Colour	Ø		€
329	black	11 cm	1/50	

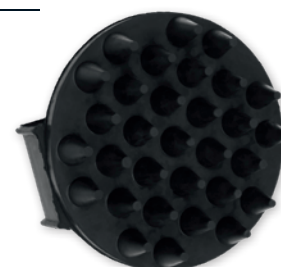

Grooming glove

- one side with numbs and one side with hard bristles
- ideal for cleaning and massage

Ref. no.	Colour	Length	Width		€
3211	red	17 cm	13 cm	1/25/100	



Reform Curry Comb

- oval shape • with leather wrist strap • with 3 fine rows of undulated teeth • galvanised

Ref. no.	Length	Width		€
1863	16,5 cm	11 cm	1/20	



Reform Curry Comb

- with 3 rows of undulated teeth • oval shape • painted black • with wrist loop

Ref. no.	Length	Width		€
1816	17 cm	10 cm	1/100	



Metal currycomb with mane comb

- quadruple wire bearing • colourless varnish • with mane comb
- fine-toothed • with wooden handle • 8-row pierced • can be used on both sides

Ref. no.	Length of the curry comb surface	Width of curry comb surface		€
1811	12 cm	12,5 cm	1/12	



Spiral Curry Comb

- especially suitable for horses • can be used on both sides
- fine-toothed • Material: stainless steel • Handle material: Plastic

Ref. no.	Ø curry comb surface		€
1815	10,5 cm	1/10/50	



Metal Curry Comb

- with 2 knocking-off pieces • robust design • especially suitable for horses
- 8-row • fine-toothed • Material: galvanised metal • Handle material: Plastic

Ref. no.	Length of the curry comb surface	Width of curry comb surface		€
189	9,5 cm	14,5 cm	1/12/48	



Needle curry comb

- fine-toothed • with adjustable wrist strap
- Material: polyethylene

Ref. no.	Colour	Length	Height		€
1885	black	17,5 cm	8,5 cm	1/25/125	
1883	blue	17,5 cm	8,5 cm	1/25/125	
1881	red	17,5 cm	8,5 cm	1/25/125	



Coat Cleaning Stone WonderStone

- removes dirt easily and effortlessly • simply rub the stone with the grain over the coat

Ref. no.	Colour	Length	Width	Height		€
321628	black	11 cm	10 cm	4 cm	1/25/100	
81948	black	12 cm	6 cm	3 cm	1/12/24/120	



Covalliero Sponge, Viscose

- can be used wet and dry • made from absorbent and wear-resistant foam

New product 

Ref. no.	Colour	Length	Width	Height		€
3230294	yellow	10 cm	7,5 cm	4 cm	1/100	

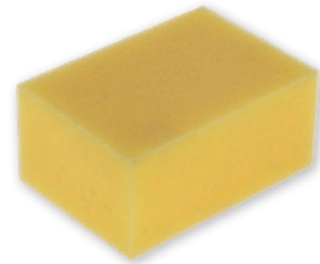

Cleaning sponge

- ergonomic shape • made from absorbent and wear-resistant foam

Ref. no.	Colour	Length	Width	Height		€
321624	yellow	23 cm	12 cm	5 cm	1/100	



Sponge Flecki

- horse-shaped • set of 3: blue, pink and yellow • can be used wet and dry • made from absorbent and wear-resistant foam

Ref. no.	Colour	MOQ	Pieces / unit		€
328297	blue / pink / yellow	1 pack	3 / pack	1/40	

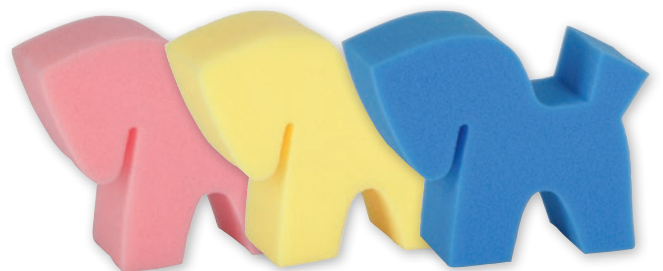

Sponge

- can be used wet and dry • made from absorbent and wear-resistant foam



Ref. no.	Colour		€
32818	yellow	1/10/200	

Sponge

- for wet and dry use • extremely absorbent and abrasion-resistant
- Material: Viscose



Ref. no.	Colour		€
3293	yellow	1/144	

Grooming glove

- the alternative to conventional grooming gloves • rubber drawstring prevents continuous slipping during grooming • microfibre material picks up even the finest dust particles • washable at 30 °C



Ref. no.	Colour		€
321300	blue	1/100	

Washing brush

- Bristle material: Polyamide • Material: Plastic



up to 60 °C heat-resistant

Ref. no.	Colour	Length		€
2916	white	19 cm	1/50	

Sweat Scraper Half-round

- with rubber-like wiper lip



Ref. no.	Colour		€
3275	blue	1/18/72	

Sweat Scraper Straight

- with two plastic handles • sturdy metal design



Ref. no.	Colour	Length	Width		€
3277	black	77,5 cm	7 cm	1/50	

Pet hair remover

- removes dead pet hair and loose undercoat • suitable for all coat lengths • does not damage healthy top hair • ergonomically shaped handle with side rubber slats for maximum ease of handling • also suitable for horses



Ref. no.	Colour	Length	Width		€
80068	turquoise / grey	15 cm	7,5 cm	1/3/24/72	
80069	turquoise / grey	15 cm	10 cm	1/3/24/72	

Universal and mane scissors

- for cutting manes, tails and other materials • asymmetrical grip for easy handling
- made from rust-resistant stainless steel

Ref. no.	Colour	Length		€
3230525	black	24 cm	1/100	

New product

NEW



Coat Thinning Shears

- with handy finger hook • ideal for thinning out and cutting thick hair
- high-quality, chrome-plated material

Ref. no.	Length	Toothing	Blade length			€
83289	17 cm	teeth on two sides	6 cm	1/3/36	864	



Mane Comb

- Material: Aluminium

Ref. no.	Length		€
1820	20 cm	1/10/100/400	
1820/1	20 cm	1/100/200	



Mane Comb

- Material: Aluminium

Ref. no.	Length		€
1821	10 cm	1/10/100/400	
1821/1	10 cm	1/100/200	



Mane Comb

- Material: Aluminium

Ref. no.	Length		€
32625	9 cm	1/10/500/1000	
32625/1	9 cm	1/25/100	

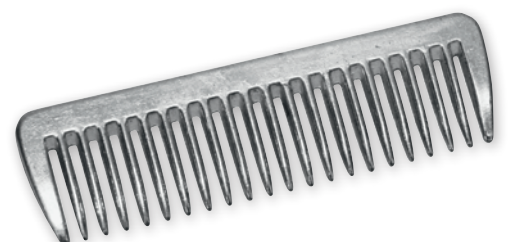

Grooming Box Jumbo



Finally a grooming box in which all care utensils can be stored including various high bottles. The stable plastic construction and the easy-to-close lid offer reliable protection of the contents.

- perfect storage space for bottles on the exterior
- partitions in the interior ensure organisation
- with many details such as a removable small parts and brush tray or a device for attaching whips
- reinforced lid for loads up to 120 kg
- large, easy-to-operate closure
- with lock-up device, e.g. via a padlock (not included in the scope of delivery)
- with handle



Made in Italy



Ref. no.	Colour	Length	Width	Height			€
3220553	blue / black	52 cm	32 cm	31 cm	1/2	24	



Grooming Box Siena

- made from sturdy plastic with a reinforced cover
- correctly closed box can be laden up to max. 100 kg
- incl. removable insert and brush holder
- with handle



Made in Italy



Ref. no.	Colour	Length	Width	Height			€
328267	capri blue	40 cm	26 cm	24,5 cm	1/6	72	
328268	dark blue	40 cm	26 cm	24,5 cm	1/6	72	
321757	navy blue / light blue	40 cm	26 cm	24,5 cm	1/6	72	



Grooming Box Siena

The Siena Grooming Box is now also made from recycled material for greater sustainability

- made from sturdy plastic with a reinforced cover
- correctly closed box can be laden up to max. 100 kg
- incl. removable insert and brush holder
- with handle



Made in Italy



Ref. no.	Colour	Length	Width	Height			€
321788	grey / pink	40 cm	26 cm	24,5 cm	1/6	72	





Grooming Box Arrezzo

- for storing toys and toiletries
- suitable for on the move and at home
- with removable insert
- cover with 2 stable sealing flaps
- made of high-grade plastic



Made in Italy



Ref. no.	Colour	Length	Width	Height			€
321747	black / pistachio	40 cm	25 cm	24,5 cm	1/6	72	
321789	black / fuchsia	40 cm	25 cm	24,5 cm	1/6	72	

Grooming Box Roma

- large cleaning box in a modern shape and colours
- the optimum dimensions and an additional partition mean even bottles stored upright have a place
- a sturdy central closure flap ensures fast opening and closing
- the sturdy handle integrated into the lid means even a fully packed box can be carried safely
- Removable compartment for small items



Made in Italy



pearlescent

Ref. no.	Colour	Length	Width	Height			€
321770	dark blue	40 cm	30 cm	29 cm	1/4	48	

Box Bag Milano

Stable and practical box bag for neat and orderly storage of e.g. care tools, gaiters, halters etc. in stables or at tournaments.

- made from stain-resistant, easy-care and sturdy material
- extremely water-resistant, coated Oxford fabric protects against rain and dirt
- plenty of storage space for various utensils
- safe attachment with a wooden stick
- with strong base and walls
- upper cover can be close using hook-and-loop fastener
- without contents



Ref. no.	Colour	Length	Width	Height		€
3225356	navy / camel	66 cm	25 cm	60 cm	1/8	

Covalliero Grooming Bag Milano

The sophisticated-looking grooming bag with many outer pockets and ample storage space inside.

- made from stain-resistant, easy-care and sturdy material
- includes removable shoulder strap with shoulder padding
- with 360° zip opening for easy filling
- with stable base and removable inner divider
- side pocket with zip for additional storage
- Carry Straps with Handle
- without contents



Ref. no.	Colour	Length	Width	Height		€
3223341	navy / camel	46 cm	20,5 cm	26 cm	1/20	

Blanket Bag Milano

Practical bag for storing and transporting horse blankets and other utensils.

- made from stain-resistant, easy-care and sturdy material
- extremely water-resistant, coated Oxford fabric protects against rain and dirt
- for storing up to 5 blankets (depending on blanket size)
- two carry handles
- generous zip fastener
- with strong base
- incl. removable shoulder strap
- without contents

Ref. no.	Colour	Length	Width	Height		€
3297793	navy / camel	68 cm	36 cm	46 cm	1/12	



Grooming Box AluSafe

- in lightweight aluminium construction for effortless carrying
- with reinforced corners
- with two dividing walls, variably adjustable
- lockable with key
- foam padding throughout inside
- incl. handy small utensils pocket
- with carrying strap



Ref. no.	Length	Width	Height			€
320137	40 cm	30 cm	30 cm	1/2	36	



Grooming Rucksack

Everything clearly packaged in a transparent bag

Ref. no.	Colour		€
321358	pink	1/10	
32796	blue	1/10	



Grooming Bag

- for storing toys and toiletries
- suitable for on the move and at home
- made from stain-resistant, easy-care and sturdy material
- with 6 outer pockets for plenty of storage
- includes removable shoulder strap with shoulder padding
- without contents
- with handle
- with a zip fastener



Ref. no.	Colour	Length	Width	Height		€
3230526	black / cognac	28 cm	20 cm	22 cm	1/20	
3230527	dark blue / cognac	28 cm	20 cm	22 cm	1/20	

NEW
NEW

Grooming Box WaterLily

- sustainably produced plastic: contains up to 60 % recycled component in the plastic (polypropylene) - additional use of rice and straw fibres up to 55 %
- for storage of care products
- with removable insert and carrying handle
- included: grooming box, hoof pick with natural fibre bristles, curry comb, mane brush with natural fibre bristles, grooming brush with horsehair bristles, mane and tail brush

New product

NEW



Ref. no.	Colour		€
3230295	pastel pink	1/8	
3230296	pastel blue	1/8	

Grooming Box 7-piece filled

- complete with removable insert

Included in delivery: 1 x care box, 1 x rubber curry comb oval, 1 x hoof cleaner, 1 x viscose sponge, 1 x mane brush standard small, 1 x plastic bristle curry comb, 1 x horse brush, 1 x mane comb stemless





Ref. no.			€
321775	1/6	54	

Grooming Box 8-piece filled

for children

- with everything you need to care for your favourite horse
- Material: Polypropylene





Ref. no.	Colour			€
321765	purple	1/8	64	
321766	pink	1/8	64	



All-round Box

- for proper storage • Material: Plastic



Ref. no.	Colour	Length	Width	Height			€
321776	blue	38 cm	25 cm	11,5 cm	1/30	360	
321778	green	38 cm	25 cm	11,5 cm	1/30	360	

Mane gum

- ideal for weaving in



Ref. no.	Colour	MOQ	Pieces / unit		€
321477	white	1 pouch	500 / pouch	1/100	
321478	black	1 pouch	500 / pouch	1/100	
321470	white	1 pack	800 / pack	1/75/150	
321471	black	1 pack	800 / pack	1/75/150	

Mane Rubber Silicone

- extremely stretchable silicon material
- excellent tear resistance
- ideal for weaving in



Ref. no.	Colour	MOQ	Pieces / unit		€
321479	white	1 pouch	500 / pouch	1/100	
321480	black	1 pouch	500 / pouch	1/100	

Tournament Number

- made from soft plastic
- in pairs



321467
for hook and loop fastening



321468



321469

Ref. no.	Description	Colour		€
321467	3-digit	white / black	1/250	
321468	3-digit	white / black	1/200	
321469	4-digit	white / black	1/250	



Leder-New

Leather cleaning and care in one product

- cleans leather deep down • removes contamination from dirt, grease and sweat with ease and also provides a shiny appearance • smoothes cracked leather and brings out the natural colour
- does not contain any grease, therefore does not leave any residue on clothing

Ref. no.	Contents		€
3223426	500 ml / Spray bottle	1/6	

Leather Oil

- the perfect basic leather care • makes leather supple, waterproof and particularly resilient
- suitable for saddles, bridles and all smooth leather goods

Ref. no.	Contents		€
3227332	500 ml / Bottle	1/6	
3227333	1000 ml / Bottle	1/6	

Dubbin

- the perfect basic leather care • makes leather supple, waterproof and particularly resilient
- suitable for saddles, bridles and all smooth leather goods

Ref. no.	Contents		€
3227330	500 ml / Can	1/6	
3227331	1000 ml / Can	1/12	

Beeswax Leather Care Cream

- retains the value and the inherent properties of the leather • cleans the surface and penetrates deep into the pores • with genuine beeswax • preserves, cares for and makes leather tear-resistant and durable
- with self-cleaning effect • provides intensive and deeply effective care • with impregnation effect

Ref. no.	Contents		€
32553	500 ml / Can	1/6	

with genuine beeswax

Beeswax leather oil

- for the care and revitalisation of leather • protects against brittleness • preserves the leather and makes it soft and resistant • provides intensive and deeply effective care • with impregnation effect

Ref. no.	Contents		€
32552	1000 ml / Bottle	8	

with genuine beeswax

Saddle Soap Bar

- contains a combination of fats developed on a native base, that covers leather with a protecting and preserving coat • even heavily worn leather remains soft and supple

Ref. no.	Contents		€
32551	200 g	1/12	

with leather protectant!

Leather Soap Glycerine

- contains glycerine • cleans and cares in one step • gives smooth leather, shoes and boots new shine and freshness • with sponge

Ref. no.	Contents		€
3227329	200 ml / Can	1/12	

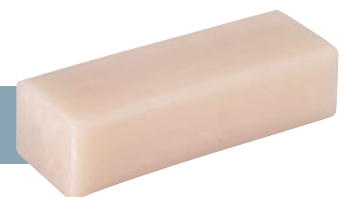



MagicBrush Leather lotion 2in 1

- removes light soiling and forms a protective layer against the effects of weathering
- keeps leather soft, supple and protects it from drying out and cracking
- gives the leather a natural gloss. Ensures long-term protection and maintains the durability of the leather
- spray and rub in with a soft cloth
- suitable for bridles, saddles, boots and all smooth leather goods

with aloe vera extract and almond oil

New product

NEW

Ref. no.	Contents		€
3230529	500 ml / Spray bottle	1/12	

Made in the EU



MagicBrush Leather Care 3in1

For everyone who wants to clean and care for their smooth leather simply and quickly! Puts an end to time-consuming leather care: drop the solution in cold water, swirl the dirty leather briefly in the liquid and hang it up to dry! After a few (approx. 15) minutes, the leather can be used again. Simply wipe down boots, saddles and other smooth leather with a sponge soaked in the solution and you're done!

- 3-in-1: one product, three results - cleaning, care and oiling!
- for all smooth leather saddles and bridles
- easy to use with no scrubbing - works automatically in just a few minutes

extremely economical concentrate



Top Seller

Ref. no.	Contents		€
3223435	1000 ml / Bottle	1/6	

Made in the EU



MagicBrush Leather Oil Premium

- suitable for care of bridles, saddles, boots and all smooth leather goods
- components that clean and replenish penetrate deep into the leather to make it durable and tear-resistant again
- selected oils protect against moisture and mould
- cares for leather that is subject to heavy wear and restores lost gloss
- hard leather becomes supple again with regular use

with macadamia oil

Ref. no.	Contents		€
3223432	500 ml / Bottle	1/12	
3223433	1000 ml / Bottle	1/6	



Made in the EU



MagicBrush Dubbin

- protects leather from moisture, mould and breakage and makes it durable
- suitable for care of bridles, saddles, boots and all smooth leather goods
- cares for leather that is subject to heavy wear and restores lost gloss
- selected plant oils penetrate deep into the leather providing nourishment, protection and care.
- hard leather becomes supple again with regular use

with beeswax

Ref. no.	Contents		€
3223430	450 ml / Can	1/12	
3223431	1000 ml / Can	1/6	

Made in the EU



MagicBrush Leather Oil Spray

- high-quality oils make the leather soft and resilient
- the special formulation penetrates deep into the pores and supplies the leather with important nutrients
- leather oil protects leather from drying out and hinders the penetration of moisture and UV radiation
- simple application: Spray function distributes the oil evenly over the surface

Ref. no.	Contents		€
321586	225 ml / Spray Can	1/12	

Made in the EU



MagicBrush Saddle and leather soap

- for smooth, suede and Nubuck leather
- removes even the most stubborn stains and makes the leather wonderfully supple
- mild and gentle cleaning

with coconut oil

Ref. no.	Contents		€
3223434	500 ml / Can	1/12	

Made in the EU



MagicBrush Hoof gel Pro

- specially formulated gel for highly stressed hooves • penetrates deep into the affected areas and can promote regeneration • protects against excessive moisture from the outside, which favours thrush • easy to apply, adheres well and dries quickly without sticking to the hoof • regular use protects against hoof problems long term and maintains hoof health



with aluminium and zinc sulphate

Ref. no.	Contents		€
3230531	200 ml / Bottle	1/15	

New product 



Made in the EU 

MagicBrush Hoof oil Premium

- high-quality hoof oil with growth-promoting bay oil
- protects the hoof from drying and becoming brittle
- gives hooves a cared-for and healthy appearance
- when used daily, gives your horse's hooves the best protection against external influences
- keeps the hoof horn supple and breathable so the hoof is optimally nourished and retains its natural glossiness



with avocado oil, macadamia oil and vitamin E

Ref. no.	Contents			€
3223438	500 ml / Bottle	1/12	648	
3223439	425 ml / Brush Can	1/14	576	

 Top Quality



Made in the EU 

MagicBrush Hoof Fat

- with plant oils, natural waxes and bay extract
- protects the hoof from drying
- gives hooves a cared-for and healthy appearance
- when used daily, gives your horse's hooves the best protection against external influences
- keeps the hoof horn supple and breathable so the hoof is optimally nourished and retains its natural glossiness



with bay extract

Ref. no.	Colour	Contents			€
3224536	yellow	1000 ml / Can	1/6	576	
3223436	black	1000 ml / Can	1/6	576	
3223437	green	1000 ml / Can	1/6	576	
3224537	yellow	2500 ml / Bucket	1/3	120	
3223378	black	2500 ml / Bucket	1/3	120	
3223377	green	2500 ml / Bucket	1/3	120	

 Top Seller

Made in the EU 

Iodine soap

• especially suitable for disinfectant cleaning of horses • highly effective against fungi, yeasts and bacteria, such as scurf and thrush

Ref. no.	Contents			€
3227334	500 ml	1/6	600	

Use product safely. Always read the label and product information before use.



Hoof Oil Strengthener

Hoof Oil Strengthener cares for hooves in a special way by being quickly absorbed into the keratin body and therefore not clogging the hoof pores. Hoof Oil Strengthener has a positive effect on and strengthens the hooves thanks to its special ingredients, pure vegetable oil and daily application. Horseshoes keep much longer and it protects against loose hoof walls and thrush.

• good care prevents inflammation and stunted hoof growth • keratin and putty substance can be formed sufficiently and without being disturbed • contains 100 % pure vegetable oil, avocado, jojoba, sesame and orange oil and marigold extract • highly economical in use

Ref. no.	Contents			€
3225354	475 ml / Brush Can	1/6	360	



Hoof Oil

• has a nourishing and restorative effect and is suitable for daily care • stabilises the hoof and increases elasticity • prevents thrush and brittle horn • promotes growth and gives a natural, healthy look • contains natural rapeseed oil, natural avocado oil, natural thyme oil, natural wintergreen oil, natural eucalyptus oil and vitamin E

Ref. no.	Contents			€
32540	500 ml / Bottle	1/6	600	
3225355	475 ml / Brush Can	1/6	360	



Hoof Fat

• the perfect daily hoof care • ensures preservation of good and elastic hoof quality • suitable for all hoof types

Ref. no.	Contents			€
1654	1000 ml / Can	1/12	576	



Hoof Balm Strengthener

Indispensable for regular hoof care and prevention of dry, cracked hooves. Hoof Balm Strengthener strengthens and cares naturally. High-quality oils and waxes in conjunction with valuable natural ingredients result in an invigorating effect. Promotes growth, keeps the hoof elastic, protects against drying out and getting brittle.

Ref. no.	Contents			€
32542	500 ml / Can	1/6	960	
32543	1000 ml / Can	1/12	360	



THE comprehensive hoof care!

Hoof Pick with Horse's Head

• with cleaning brush • made of robust plastic

Ref. no.	Colour		€
321616	purple	1/100/200	
321617	green	1/100/200	
321618	orange	1/100/200	

Hoof Pick with Brush

• made of robust plastic • with cleaning brush

Ref. no.	Colour		€
321145	red	1/100/200	
321146	blue	1/100/200	
321147	green	1/100/200	
321148	yellow	1/100/200	
321149	black	1/100/200	

Hoof Pick

• for scraping and better hoof cleaning • handle made of sturdy plastic

Ref. no.	Colour		€
321647	blue	1/250/500	
321656	red	1/250/500	
321659	black	1/250/500	

Multipurpose Knife

• with beautifully shaped wooden handle • Stainless steel blade • with hoof pick, universal blade, hoof cutter, can and bottle opener and mane blade

Ref. no.	Length	MOQ	Pieces / unit		€
32679/1	10 cm	1 blister pack	1 / blister pack	1	
32679	10 cm			1/12/120	

Hoof Brush with Can

• complete with can for clean use and/or storage • Material: Plastic

Ref. no.	Colour		€
3282	black	1/75/150	

Hoof Brush with Cap

• practical and clean in use or storage • Material: Plastic

Ref. no.	Colour		€
3285	black	1/100	



All professional hoof and claw knives impress with their uncompromising quality throughout

- the special stainless steel alloy of the blade with the increased chrome content impresses thanks to its greater wearing hardness, longer service life and exceptional mechanical resilience
- the polished surface and perfect grinding properties of the blade steel ensure that you have in your hands the perfect tool for tough everyday use in animal care
- the water-resistant, impregnated hardwood handle transfers the user's strength to the blade perfectly



Hoof and claw knife SuperProfi

The knife for the professional hoof trimmer and farrier as well as for anyone who needs a perfect tool for hoof and claw care!

- high alloy special steel for long life and grindability
- 0° scalpel cut for exceptional sharpness and cutting performance
- ergonomic handle made from heat-treated beech wood



as sharp as a scalpel



Ref. no.	Length	Cutting side	Blade length	Blade width	Cutting edge length		€
16814	210 mm	single-edge right	70 mm	10 mm	57 mm	1/10/100	
16815	210 mm	single-edge left	70 mm	10 mm	57 mm	1/10/100	

Hoof and claw knife ProfiCurv

Hoof and claw knife for professional use with specially offset blade made of special knife steel

- short, offset blade also for narrow working radii
- high alloy special steel for long life and grindability
- one-sided professional grind for exceptional sharpness and cutting performance
- ergonomic handle made from heat-treated beech wood
- perfect power transmission due to optimised leverage of handle and blade



extremely sharp and agile

Ref. no.	Length	Cutting side	Blade length	Blade width	Cutting edge length		€
16823	210 mm	single-edge right	67 mm	13 mm	55 mm	1/10/100	
16824	210 mm	single-edge left	67 mm	13 mm	55 mm	1/10/100	

Hoof and claw knife ProfiLoop

Hoof and claw knife for professional use with loop blade for working from both sides

- Loop blade for right- and left-handed use or for working on both sides
- high alloy special steel for long life and grindability
- Special grind for exceptional sharpness and cutting performance
- ergonomic handle made from heat-treated beech wood
- perfect power transmission due to optimised leverage of handle and blade



can be used in either hand

Ref. no.	Length	Cutting side	Blade length	Blade width	Cutting edge length		€
16825	195 mm	double-edged	55 mm	12 mm	40 mm	1/10/100	

Hoof and claw knife Profi

- made from high-quality special steel developed for cutting tools
- improved cutting performance
- optimised grinding properties
- revised blade radius for more precise working
- ergonomically shaped noble wood handle for fatigue-free working



Top Seller

Ref. no.	Length	Cutting side	Blade length	Blade width	Cutting edge length		€
16801	20 cm	single-edge right	82 mm	11 mm	71 mm	1/10/200	
16801/1	20 cm	single-edge right	82 mm	11 mm	71 mm	1/10/100	
16802	20 cm	single-edge right	80 mm	17 mm	70 mm	1/10/200	
16803	20 cm	single-edge left	82 mm	11 mm	71 mm	1/10/200	
16803/1	20 cm	single-edge left	82 mm	11 mm	71 mm	1/10/100	
16804	20 cm	single-edge left	80 mm	17 mm	70 mm	1/10/200	
16805	20 cm	double-edged	80 mm	17 mm	70 mm	1/10/200	
16805/1	20 cm	double-edged	80 mm	17 mm	70 mm	1/10/100	

Aesculap Hoof and claw knife

- hardwood handle ergonomically shaped for fatigue-free working
- stainless steel blade set of the highest quality for best durability and re-grinding properties
- 2-stage grinding for maximum precision
- for veterinarians, hoof trimmers and farmers



Ref. no.	Length	Cutting side	Blade length	Blade width	Cutting edge length		€
GTA300	20 cm	single-edge right	80 mm	13 mm	65 mm	1/10/100	
GTA302	21 cm	single-edge right	83 mm	18 mm	69 mm	1/10/100	
GTA305	20 cm	single-edge left	80 mm	13 mm	65 mm	1/10/100	
GTA307	21 cm	single-edge left	83 mm	18 mm	69 mm	1/10/100	
GTA315	20 cm	double-edged	78 mm	17 mm	35 mm / 65 mm	1/10/100	
GTA316	21 cm	double-edged	83 mm	18 mm	40 mm / 69 mm	1/10/100	
GTA317	21 cm	double-edged	83 mm	19 mm	40 mm / 69 mm	1/10/100	

Aesculap Hoof and claw knife Expert

- hardwood handle ergonomically shaped for fatigue-free working
- stainless steel blade set of the highest quality for best durability and re-grinding properties
- 2-stage grinding for maximum precision
- with extra-sharp scalpel grind
- for professional users



Ref. no.	Length	Cutting side	Blade length	Blade width	Cutting edge length		€
GTA320	20 cm	single-edge right	80 mm	13 mm	65 mm	1/10/100	
GTA321	20 cm	single-edge left	80 mm	13 mm	65 mm	1/10/100	

Aesculap Hoof and Claw Knife Danish Design Expert

• thermally treated hardwood handle ergonomically shaped for fatigue-free working • stainless steel blade set of the highest quality for best durability and re-grinding properties • 2-stage grinding for maximum precision • for professional users



Ref. no.	Length	Cutting side	Blade length	Blade width	Cutting edge length		€
GTA310	20 cm	single-edge right	80 mm	13 mm	65 mm	1/10/100	
GTA311	20 cm	single-edge left	80 mm	13 mm	65 mm	1/10/100	

Aesculap Hoof and claw knife ProCut

A hoof and claw knife with a highly ergonomic plastic handle for the professional hoof trimmer and farrier as well as for anyone who needs an optimum tool for hoof and claw care that delivers even more hygiene.

- especially ergonomically shaped plastic handle for even less fatigue
- extremely hygienic handle since it is easy to clean, heat-resistant, impact and wear-resistant
- high alloy special steel for long life and grindability
- 0° scalpel cut for exceptional sharpness and cutting performance
- the grip sits comfortably and naturally in the hand, significantly reducing tension and strain



New product 

as sharp as a scalpel

available from: February 2025

Ref. no.	Length	Cutting side	Blade length	Blade width	Cutting edge length		€
GTA322	215 mm	single-edge right	65 mm	10 mm	56 mm	1	
GTA323	215 mm	single-edge left	65 mm	10 mm	56 mm	1	

Hoof Stand EcoFlex

The new 2-in-1 solution for treating front and rear hooves with a hoof stand. The horse is able to relax more during its hoof care without you needing to bear its weight.

- protects the back and knees • easy to use • very precise and simple height adjustment thanks to the folding set screw • support surface for the front hoof made from sturdy hardened rubber • support strap for the rear hoof made from soft and durable polypropylene • an innovative design reduces the risk of injury during hoof care • suitable for various sizes and breeds of horse • also suitable for older horses that need more comfort and assistance during hoof care



for rear hooves

for front hooves

Ref. no.		€
16180	1	



 **Top Seller**

DICK Diamond Sharpening Rod

- excellent professional tool • Working length and diamond coating are ideal for sharpening the cutting edges and curves (channels) of all hoof knives
- with Ergonom Sympa handle with hanging hole • High service life • also for other cutting tools

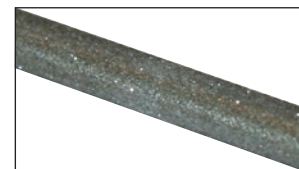

Ref. no.	Length		€
16169	31 cm	1/5	



Made in Germany



DICK Hoof Rasp

- flat, blunt shape with plastic handle
- high power: one side with extra-sharp and deep rasp cut, one side with coarse file cut



Ref. no.	Cut length	Width	Height		€
16168	20 cm	4,5 cm	0,5 cm	1/5	
16165	30 cm	4,2 cm	0,5 cm	1/5	

Made in Germany



DICK Chopping Blade

- Hatchet-Shaped Chopping Blade
- specially sharpened cutting edge
- high-quality, rust-free carbon steel
- with "softgrip" PVC handle



Ref. no.	Length	Blade width		€
1657	36 cm	3,1 cm	1/10	

Made in Germany



Hoof Rasp with Handle

- Handle length: 12.5 cm

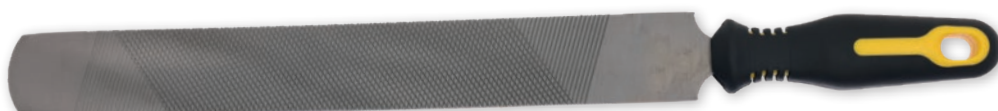

Ref. no.	Cut length		€
16161	35 cm	1/5/20	

Hoof Rasp

- straight design
- with extra sharp and deep rasp cut



Ref. no.	Cut length	Width	Height		€
1616	35 cm	3,6 cm	0,75 cm	1/5/40	

Cutting Blade with Handle

- whetted
- Material: stainless steel



Ref. no.	Length	Blade width		€
1615	30 cm	3 cm	1/10/60	

Sharpening Stone

- for hoof knives
- flat oval shape

Ref. no.	Length		€
1612	120 mm	1/200	



Top Seller

DICK Shoeing Mallet

- robust design

Ref. no.	Material	Length		€
32670	Beechwood	30 cm	1/25	



Made in Germany



Shoeing Hammer

- forged design • with steel-reinforced wooden handle

Ref. no.	Length		€
1650	33 cm	1/12/48	



Hoof-Checking Pliers

- forged steel • with straight legs

Ref. no.	Length		€
1619	30 cm	1/6/30	



Hoof pliers

- robust design

Ref. no.	Length		€
16182	36 cm	1/5/25	



KNIPEX Hoof Pliers

- with rivet joint • can also be used as farrier's tongs • Cutting edge hardness approximately 56 HRC • Special tool steel, oil-hardened

Ref. no.	Length		€
1618	30 cm	1/6	



Top Quality

Hoof Nail Clinch

- for pulling hoof nails

Ref. no.	Length		€
1666	35 cm	1/6/36	





Hoof Shoe Tubbease™

Tubbease™ was developed in New Zealand with the aim to create a breathable treatment shoe for problem horse hooves (e.g. sole ulcers). The supplied hook and loop tapes mean Tubbease™ is easy to attach to the horse's leg.

- can escape upwards meaning no heat or humidity is trapped within the shoe
- the rubber-coated base reliably prevents moisture from entering and simultaneously ensures that the treatment fluid remains on the hoof
- the optimum climate within the shoe means the hoof retains its natural strength
- the thick EVA insole reduces pressure pain for the horse (e.g. with sole ulcers) and extends the life of Tubbease™
- various remedies to treat abscesses, thrush, hoof injuries, hoof outbreaks etc. can be used with Tubbease™
- tubbease™ design is protected (NZ 417646)
- EVA insert not included

Important: only use during stall rest

Ref. no.	Colour	Size	Ø		€
3210559	pink	S	11 cm	1/30	
3226303	green	S / M	13 cm	1/30	
3210560	red	M	14 cm	1/30	
3210561	blue	L	16 cm	1/30	
3210596	yellow	XXL	17,5 cm	1/30	

Ref. no.	Description	Colour	Size		€
3210595	EVA Insert Tubbease™	pink	S	1/2/30	
3222300	Hook and Loop Fastener, in pairs	pink		1/40	
3226304	EVA Insert Tubbease™	green	S / M	1/2/30	
3226305	Hook and Loop Fastener, in pairs	green		1/30	
3210564	EVA Insert Tubbease™	red	M	1/2/30	
3222301	Hook and Loop Fastener, in pairs	red		1/40	
3210565	EVA Insert Tubbease™	blue	L	1/2/30	
3222302	Hook and Loop Fastener, in pairs	blue		1/40	
3210597	EVA Insert Tubbease™	yellow	XXL	1/2/30	
3222304	Hook and Loop Fastener, in pairs	yellow		1/40	

TV



Treatment Shoe for Hooves

Durable and robust treatment shoe made of canvas with two bands. Ideal for treating horse or cattle hooves with ointments or solutions.

- strong plastic sheet on the inside to allow the treatment solution to work effectively
- Standard size (15 x 30 cm)

Ref. no.	Colour	Length	Width		€
16143	brown	30 cm	15 cm	1/50	



SHOOF Horse Shoe

- is used to treat injury or inflammation of the hoof
- made from sturdy, durable polyurethane
- reusable
- light and comfortable

3260: hoof width up to 130 mm

3261: hoof width up to 145 mm

3263: hoof width up to 160 mm

Ref. no.	Size		€
3260	S	1/10	
3261	M	1/10	
3263	L	1/10	



Ref. no.	Description		€
3262	Replacement Set for Horseshoe	1/400	

certoplast Hoof Bandage Typ 513

- high-quality viscose fabric, combined with a particularly strong synthetic rubber-based adhesive
- very high adhesive strength on virtually all substrates
- soft and cosy
- easy to tear by hand
- Fabric composition: 100 % viscose

Ref. no.	Colour	Length	Width		€
16494	black	50 m	50 mm	1/3/9	

New product

NEW

Made in Germany



Hoof Bandage VetTape

- with strong rubber adhesive
- adheres securely
- tried and tested for hoof bandages
- air permeable

Recommended by veterinarians!

Ref. no.	Colour	Length	Width		€
16390	black	50 m	50 mm	1/12	

Hoof Bandage Silbertape

- watertight design (suitable for pens)
- excellent tear resistance
- very good adhesive properties
- easy to use

Ref. no.	Colour	Length	Width		€
16385	silver	50 m	50 mm	1/24	

Self-adhesive Bandage EquiLastic

- highly-elastic, self-adhesive bandage
- very hard to tear lengthwise, but easy to tear laterally
- does not stick to hair or to itself
- easy to put on, even on the most difficult places
- Year-round bandage for support and other dressings.

The ideal bandage for riding sports and claw care!

The optimal summer bandage for claw care!

Ref. no.	Colour	Length	Width		€
1684	white	450 cm	5 cm	1/12/288	
1685	red	450 cm	5 cm	1/12/288	
1683	blue	450 cm	5 cm	1/12/288	
1686	black	450 cm	5 cm	1/12/288	
16550	green	450 cm	5 cm	1/12/288	
16551	violet	450 cm	5 cm	1/12/288	
1690	white	450 cm	7,5 cm	1/12/192	
1687	red	450 cm	7,5 cm	1/12/192	
1688	blue	450 cm	7,5 cm	1/12/192	
1689	black	450 cm	7,5 cm	1/12/192	
16552	green	450 cm	7,5 cm	1/12/192	
16553	violet	450 cm	7,5 cm	1/12/192	
1692	white	450 cm	10 cm	1/12/144	
1694	red	450 cm	10 cm	1/12/144	
1695	blue	450 cm	10 cm	1/12/144	
1697	black	450 cm	10 cm	1/12/144	
16554	green	450 cm	10 cm	1/12/144	
16555	violet	450 cm	10 cm	1/12/144	



Top Seller

This product was specially developed to treat large animals and is only for use in veterinary medicine/hoof and claw care.



Padding Fleece Absorba

- THE alternative to gauze • excellent absorbent padding fleece, soft as silk and porous • can be used as a wound dressing and swab on both sides • best absorbent properties for better healing as dry wounds are no culture for pathogenic germs • Purity according to Ph.Eur. • packaged in a practical transparent box



Ref. no.	Colour	Length	Width		€
16453	white	5 m	10 cm	1/24	

This product was specially developed to treat large animals and is only for use in veterinary medicine/hoof and claw care.

Padded Bandage CottinoStar

- rolled absorbent cotton for individual padding of bandages • 100 % cotton compressed for easy use • good lengthwise tear strength, but still easy to tear by hand • Composition: 100 % Cotton



This product was specially developed to treat large animals and is only for use in veterinary medicine/hoof and claw care.

Ref. no.	Colour	Length	Width	Contents	MOQ	Pieces / unit		€
16478	white	3 m	10 cm	6 pieces / Clinic Pack	1 pack	6 / pack	1/24	

Cotton Roll VisCotto

- extra soft, voluminous cotton wool in roll form
- made from 30 % cotton and 70 % viscose for the highest absorbing performance
- versatile application for padding and in hoof care



This product was specially developed to treat large animals and is only for use in veterinary medicine/hoof and claw care.

Ref. no.	Colour	Length	Width	Contents	MOQ	Pieces / unit		€
16479	white	6 m	10 cm	5 pieces / Polybag	1 pouch	5 / pouch	1/4	

Cast and support dressing TechnoCast

Fast curing, synthetic support bandage for easy application in the hoof area of cattle, horses and other small and large animals

- Easy to use: dip the dressing in water, put it on, press it on, let it harden, done!
- made from polyester material impregnated with water-reactive polyurethane resin mixture
- cured in a few minutes and fully loadable
- enormously high stability with low weight at the same time
- individually packed airtight in an aluminium-coated bag



Broad area of application in hoof and claw care

- for injured and bad hooves - including when changing from iron to bare hooves
- for claws that can no longer be treated with blocks • lasts up to 4 weeks

Ref. no.	Colour	Length	Width		€
16580	black	360 cm	7,5 cm	1/10/120	
16581	black	550 cm	10 cm	1/10/90	

This product was specially developed to treat large animals and is only for use in veterinary medicine/hoof and claw care.

Claw and pad bandage CottoPad

Absorbent and highly tearproof embossed pad bandage made of 100 % cotton

- for padding hoof and claw dressings
- very tearproof and easy to roll off due to high consolidation
- embossed cotton wool with a rough surface - easy to handle even with wet hands
- pure natural product made from 100 % cotton



This product was specially developed to treat large animals and is only for use in veterinary medicine/hoof and claw care.

100 % cotton - no binding agents

Ref. no.	Colour	Length	Width	MOQ	Pieces / unit		€
16840	white	600 cm	9 cm	12 pieces	12 / pack	1/12	

Absorbent Cotton in Gauze Cover CottoMull

fluffy cotton wool in gauze cover - ideal for large animals

- even layer thickness for good cushioning effect
- very high absorbency thanks to natural cotton
- non-slip and tearproof, so easy to put on without wrinkling
- gauze cover prevents adhesion to the wound
- for hoof, joint, and wound dressings for horses and other large animals
- also suitable for keeping joints and tendons warm, and for transport protection



This product was specially developed to treat large animals and is only for use in veterinary medicine/hoof and claw care.

Ref. no.	Colour	Length	Width		€
16491	white	6 m	40 cm	1/4	

Rolled cotton wool Rollino

Cotton wool bandage made from synthetic material which acts as padding for a variety of bandages and dressings

- made from crimped, non-absorbent polyester fibres
- especially soft and keeps its shape
- easy to roll and suitable for direct application to closed skin thanks to its skin-friendly properties
- easy and quick to apply to all body parts
- thanks to the fibre structure, the individual layers adhere well to each other and do not slip
- recommended for necessary padding especially in combination with VetLastic for hoof and claw bandaging
- can be torn by hand



This product was specially developed to treat large animals and is only for use in veterinary medicine/hoof and claw care.



Ref. no.	Colour	Length	Width	Contents	MOQ	Pieces / unit		€
16464	white	3 m	10 cm	8 pieces / Clinic Pack	1 pack	8 / pack	1/24	

Bandage scissors stainless steel

- according to Lister
- 2 tooth-free shearing blades
- sharp-ground cutting
- typical angling for blades relative to the handle for especially easy guidance and maintenance of the bandage scissors
- Material: stainless steel
- can be sterilised and disinfected

1658: For use with small animals

1659: For use with large animals and in hoof care

Ref. no.	Length			€
1658	14,5 cm	1/12/300	2.400	
1659	20 cm	1/12/240	1.920	



Fetlock Shears



- curved shape enables fast and easy opening of bandages and reduced the risk of injury to a minimum
- rust-proof design



Ref. no.	Length			€
1647	20 cm	1/12/204	4.896	

Beechwood Tar TarPaste

- viscous, high-quality beechwood tar
- well tried substance for hoof and claw care

Ref. no.	Contents			€
1635	1 kg / Can	1/12	360	
16350	5 kg / Canister	1	96	
16361	10 kg / Canister	1	60	



Top Seller

Disinfectant Spray Desino Jod Plus

Iodine skin and navel spray for all animal species

- alcoholic iodine solution – based on classic iodine disinfection
- for disinfecting skin and navel
- for local application
- suitable for all working animals

Take care when using biocides. Always read the label and product information before use!

Ref. no.	Contents			€
15894	500 ml / Spray bottle	1/12	600	



Wound care spray



to support self-healing

- ready-to-use spray
- promotes fast self-healing with superficial injuries and skin lesions
- Wounds dry faster therefore heal faster
- scabbed skin lesions are kept silky smooth and any itching that develops during the healing process is kept at bay
- the resulting protective film prevents the wound from re-opening allowing it to heal completely
- approved for all animals kept for food production
- not subject to regulations on residue levels
- spray on the affected areas 1-2 times a day for up to 1 week
- suitable for all working animals

Made in Germany





with mint oil and allantoin

Ref. no.	Contents			€
15239	500 ml / Spray bottle	1/12	480	

BlauCare

- Protection and care for severely stressed and sensitive areas of skin
- promotes healthy horn growth
- assists regeneration of the skin
- the spray form ensures quick and easy application
- no antibiotics
- no waiting time

Ref. no.	Contents			€
15882	200 ml / Spray Can	1/12	2.880	
15883	500 ml / Spray Can	1/12	1.344	



Disinfectant INTERKOKASK®

Broad spectrum stable disinfectant against coccidia oozysts, roundworm eggs, bacteria, fungal infections, viruses

- ready-to-use solution • tested effectiveness • ideal for surfaces in veterinary practices and institutes in the small animal sector, such as for pigeon lofts and aviaries, chicken coops, for rabbit, hamster and guinea pig cages and dog houses • not to be sprayed on furniture in your living room • Application time: 2 hours (then wipe with a damp cloth or rinse thoroughly)





Take care when using biocides. Always read the label and product information before use!

Ref. no.	Contents			€	Active ingredient
299698	500 ml / Spray bottle	1/10	450		Chlor cresols

Special Clay Balm

- can be used on: joints, feet, navel, muscles, tendons, udders, teats, etc.
- high-quality base substance and essential oil extracts for successful animal care
- intensively cares for the skin and tissue
- cooling
- improves perfusion
- no inhibitors

The original - tried and tested in veterinary practices!



Ref. no.	Contents			€
1558	1 kg / Can	1/12	240	
15581	3 kg / Bucket	1/6	60	
15582	5 kg / Bucket	1/4	32	



BALLISTOL animal Care Oil Animal

- for all pets and domestic animals
- for the care of sensitive skin and paw care
- for cleaning ears
- for the care of tails, hooves and coats in horses
- well tolerated

Recommended by veterinarians!

Ref. no.	Contents			€
29842	100 ml / Bottle	1/6	1.800	
29843	500 ml / Bottle	1/6	336	





Eimermachers Horse Balm

The tried-and-tested refresher after physical effort and fatigue

- with natural and proven ingredients such as camphor, rosemary, arnica and horse chestnut extracts
- refreshes and revives tired parts of the body
- dispenses moisture, non-greasy, absorbs quickly
- Skin tolerance dermatologically tested

The ORIGINAL



Ref. no.	Contents			€
321542	200 ml / Tube	1/6	1.440	
321543	500 ml / Can	1/12	600	
321544	1000 ml / Dispenser Can	1/12	192	



Blue Spray

Blue-tinting skin and hoof care spray for animals

- care and protection for highly stressed and sensitive body parts, e.g. ankle joints and interdigital areas
- stimulates skin regeneration by promoting the formation of new skin cells
- improves skin's moisture retention capacity. The skin (also scar tissue) becomes supple and elastic
- no antibiotics
- no waiting time
- no documentation requirement
- includes, among other thing, Dexpanthenol and natural oil of oregano (carvacrol), effective in skin care



Ref. no.	Contents			€
15890	200 ml / Spray Can	1/12	1.440	
158900	400 ml / Spray Can	1/12	672	



Powder Spray

Micro-fine powder spray to protect and maintain sensitive and stressed skin in animals

- Protection and care for sensitive skin, e.g. area between the legs
- supports the natural regeneration of skin and fur
- the powder it contains dries the sprayed area of skin
- no antibiotics
- no waiting time
- no documentation requirement

Ref. no.	Contents			€
15891	200 ml / Spray Can	1/12	1.440	
15876	400 ml / Spray Can	1/12	672	





Silver Spray

Silver Spray: film-forming aluminium spray for the protection of sensitive skin against dirt and other harmful environmental influences

Protects the skin with an elastic, breathable and moisture-repellent metal film.

- thanks to its particular adhesive characteristics, provides effective, caring protection and is universally applicable
- especially suitable for areas of skin that need protection against dirt and moisture (e.g. calves' horn base)



Ref. no.	Contents			€
1586	200 ml / Spray Can	1/12	1.440	



Hoof & Claw Spray

Hoof and Claw Spray: Black, film-forming and oil-containing care spray for hooves, claws and other keratinic tissue

- forms a protective film
- protects against moisture and other harmful factors (urine, manure, etc.)
- thanks to its intense black colouring, Hoof & Claw Spray is also ideal for improving the appearance of the hooves of show horses

Ref. no.	Contents			€
16402	200 ml / Spray Can	1/12	1.440	





Zinc Oxide Spray

Zinc Oxide Spray: Ointment spray to support the skin's natural regeneration in animals

Protects the skin against drying out. Smooths dry and cracked skin.

- ideal for general skin care and when the skin is especially stressed (e.g. bends in ankle and carpal joints)
- the spray works like an ointment dressing and protects against harmful environmental influences
- excellent care effect and supports the skin's natural regenerative processes
- contains zinc as an important building block for skin regeneration

Ref. no.	Contents			€
15802	200 ml / Spray Can	1/12	1.440	



Digital Thermometer for Large Animals

- with 14 cm-long probe • high precision • storage of the last value • Automatic shut-off • Waterproof
- battery change display • operated with: 1 x 3 V - CR2032 Lithium-ion • Battery included



Technical data	2138
Temperature measuring range	32 - 43,9 °C
Measuring time	8 sec
Temperature can be selected	Celsius °C / Fahrenheit °F
Temperature measurement accuracy	+/- 0,1 °C

Ref. no.		€	Ref. no.	Description		€
2138	1/6/24		29918	Button Battery 3 Volt	1/20	

Digital thermometer BigScreen

- with flexible probe • high precision • with indicator backlight: green - no fever, red - fever region • automatic audible signal at the end of measurement • storage of the last value
- Automatic shut-off • Waterproof • battery change display • operated with: 1 x 3 V - CR2032 Lithium • Battery included



Technical data	2130
Temperature measuring range	32 - 43,9 °C
Measuring time	10 sec
Temperature can be selected	Celsius °C / Fahrenheit °F
Temperature measurement accuracy	+/- 0,1 °C

Ref. no.		€	Ref. no.	Description		€
2130	1/6/24		29918	Button Battery 3 Volt	1/20	

Digital thermometer

- high precision • rapid measurement in 10 seconds (rectal) or 17 seconds (oral) • automatic audible signal at the end of measurement • storage of the last value • Automatic shut-off • each with transparent protective cover
- Waterproof • battery change display • operated with: 1 x 1.5 V - R41 Alkaline-manganese • Battery included

Technical data	
Temperature measuring range	32 - 42 °C
Measuring time	10 - 17 sec
Temperature measurement accuracy	+/- 0,1 °C

Ref. no.	Description	Colour		€
2136	with rigid probe	purple	1/10/240	
2137	with flexible probe	orange	1/10/240	



2136



2137

Digital thermometer topTEMP

- Digital thermometer for rectal use for animals • ergonomically tailored to the animal • operated with: 1 x 1.5 V - AAA (Micro) • Battery included

Technical data	21124
Temperature measuring range	32 - 42 °C
Measuring time	10 - 15 sec
Temperature can be selected	Celsius °C / Fahrenheit °F
Temperature measurement accuracy	+/- 0,1 °C
Weight	69 g

Ref. no.		€
21124	1/32	



Horsefly trap TaonX

- each trap reduces the number horseflies in the immediate vicinity by up to 95 %
- easy to assemble and extremely robust
- 2-year guarantee for metallic parts
- eco-friendly and 100 % non-toxic

323520: Floor stand included

- Height above floor level: 220 cm

323500: Link chain (supplied) or wall bracket (optionally available)

- Options for setting the height above floor level

How does the trap work?The ball heats up, simulating a target object for the horsefly to suck blood out of. After a failed attempt at drawing blood, the insect takes off vertically and sees its supposedly only exit route as being the catching container.

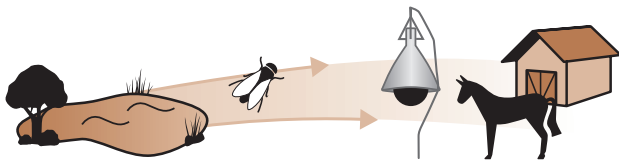

Can be used wherever horseflies are a nuisance: horse paddocks, livestock stables, riding schools, golf courses, gardens and (water) parks, amusement parks, along lakes and river banks



Ref. no.	Description	Effective area			€
323520	TaonX	10.000 m ²	1	36	
323500	TaonX Eco	5.000 m ²	1	48	



Top Seller

Ref. no.	Description	Material	suitable for		€
323511	Receptacle for TaonX	Plastic	323500, 323520	1/40	
326104	Floor bracket	galvanised metal	323520, 326102, 326103, 3224774, 299135, 3230309	1	
323506	Wall Mount	galvanised metal	323500, 326102, 326103, 3224774, 323509, 299135	1/10	

Horsefly trap TaonX Mini

The efficient horsefly trap in a smaller format for outdoor areas of up to 100 m²

The minimalist dimensions mean that the TaonX Mini is always extremely easy to install anywhere.

- TaonX Mini can be quickly and securely installed in stables, in gardens, but also on campsites, golf courses and parks, with just a few actions
- wall bracket (# 323506) is the ideal accessory
- every trap reduces horsefly presence by up to 95 % in the immediate vicinity, and has a maximum effective range of approx. 100 m²
- easy to construct
- eco-friendly and 100 % non-toxic

Tip: TaonX Mini also functions as a wasp trap, with the wasp trap liquid item (299762)



Ref. no.	Weight	Effective area			€
323509	1.545 g	100 m ²	1/4	96	

Ref. no.	Description	Material	suitable for		€
323506	Wall Mount	galvanised metal	323500, 326102, 326103, 3224774, 323509, 299135	1/10	



Horsefly and Insect Protection

cit Horsefly Protection Spray TaonX

• pleasant aroma • thanks to the special formulation, the active ingredient remains effective for many hours, even under the most difficult conditions • easy to use • spray repellent with effective protection against horseflies, mosquitoes and other arthropods • economical in use

Take care when using biocides. Always read the label and product information before use!

works for up to 6 hours

Ref. no.	Contents			€
321571	1000 ml / Spray bottle	1/6	288	
321679	5000 ml / Canister	1/4	72	

Ref. no.	Description		€
15564	Dispensing Pump for Canister	1/200	

Active ingredient

Icaridin



cit Horsefly Protection Spray TaonX Booster

• high-intensity spray repellent with effective protection against horseflies, mosquitoes and other arthropods • innovative spray system with exceptional economy • 360° sprayer: also works upside down • thanks to the special formulation, the active ingredient remains effective for many hours, even under the most difficult conditions

Take care when using biocides. Always read the label and product information before use!

works for up to 12 hours

Ref. no.	Contents			€
3223349	500 ml / Spray bottle	1/12	432	

Active ingredient

Icaridin



cit Horsefly Protection Cream TaonX

• Repellent cream with effective protection against horseflies, mosquitoes and other arthropods • for sensitive areas such as eyes or nostrils • with massaging brush head for excellent tolerance of the application process • easy to use and economical

Take care when using biocides. Always read the label and product information before use!

works for up to 6 hours

Ref. no.	Contents			€
328780	250 ml / Bottle with Brush Attachment	1/12	1.080	

Active ingredient

Icaridin





cit Insect Repellent Spray MuscaBlock

- effective fly and insect repellent • well tolerated with pleasant smell • the special formulation means the active ingredient is released gradually over many hours



Take care when using biocides. Always read the label and product information before use!

works for up to 6 hours

Ref. no.	Contents			€
299720	500 ml / Spray bottle	1/6	480	
299400	1000 ml / Spray bottle	1/12	384	

Active ingredient

Citriodiol, Pyrethrin + Pyrethroids

cit Bremsentod (Horsefly Killer) Protection Spray

- insecticide for controlling horseflies, flies, mosquitoes, black flies, etc. • for application on the animal (horse) • ready-to-use spray for application by private persons and professionals • max. duration: 3 days



Top Seller

Take care when using biocides. Always read the label and product information before use!

approx. dosage per animal is 12 ml
Protects for up to 3 days!

Ref. no.	Contents			€
15434	1000 ml / Spray bottle	1/12	288	

Active ingredient

Permethrin, geranium oil

Botfly Knife

- Special knife for scraping off botfly eggs from top coats and long hair
- to reduce the incidence of worms caused by these parasites

Ref. no.		€
322287	1/100	





Horsefly and Insect Protection

Insect Protect Spray CLAC

- safe and proven protection to fend off insects such as flies, horseflies and ticks
- especially long-lasting thanks to special ingredient icaridine

Take care when using biocides. Always read the label and product information before use!

Ref. no.	Contents			€
3227326	500 ml / Spray bottle	1/6	600	
3227327	1000 ml / Spray bottle	1/6	384	
3228280	2500 ml / Canister	1/4		

Active ingredient

Icaridin



Insect Protect Gel CLAC

- safe and proven protection to fend off insects such as flies, horseflies and ticks
- especially long-lasting thanks to special ingredient icaridine
- silent and clean application with the included sponge
- especially suitable for sensitive areas

Take care when using biocides. Always read the label and product information before use!

Ref. no.	Contents			€
3227328	500 ml / Can	1/6	726	



Garlic powder

- promotes blood circulation
- reinforces the horse's self-protection against flies and other trouble-makers
- good for digestion and metabolism
- 48 h waiting period according to ADMR

Feeding recommendation:
25-50 g per large horse per day depending on requirements

Ref. no.	Contents		€
32504	1 kg / Can	1/6	



Delizia® Garlic Plus Pellets

When the horse ingests garlic through its feed, it secretes it through its sweat glands and can thus keep insects away. Garlic can also have a stimulating effect on the animal's body.

- can strengthen the horse's body's own defences against annoying insects
- with dried garlic
- can have a stimulating effect on the metabolism and purify the blood
- the pellet form prevents the animals from blowing them out when eating
- 48 h waiting period according to ADMR

Feeding recommendation:

- Foals and ponies: 20 g per day
- Light horses: 40 g per day
- Heavy horses: 100 g per day
- 1 tablespoon = 20 g

Ref. no.	Contents		€
3228258	1 kg / Can	1/6	





BALLISTOL Sting Free Animal

- protects against mosquitoes (incl. backflies), horse flies, ticks and mites for up to 8 hours
- nourishes and protects your animal's skin
- pleasant fragrance
- contains known mosquito repellent
- also suitable for small animals such as rabbits

Take care when using biocides. Always read the label and product information before use!

Recommended by veterinarians!

Ref. no.	Contents			€
321584	750 ml / Spray bottle	1/6	336	
321589	5 L / Canister	1	90	

Active ingredient

IR 3535



cit KeinStich forte



Protective spray against stinging and biting insects.

- cit KeinStich forte is highly concentrated and acts for up to 8 hours on mosquitoes and up to 4 hours on horseflies
- cit KeinStich forte is dermatologically tested and has been rated "Very Good", and is suitable for children aged 2 years and up
- cit KeinStich forte is ideal for riders, hunters, farmers and anyone who is in regular contact with nature
- cit KeinStich forte with a watery consistency is intended for spraying on clothing etc. as well as on the skin
- cit KeinStich forte is also tropicalised
- the active ingredient has been tested against all kinds of mosquitoes / gnats, ticks and flies and against wasps, ants and horseflies - and the results have always been exceptional!
- Dermatologically tested and classified „very good“! • max. duration: 8 hours

29908: extremely fine spray mist

- as productive as a regular 550 ml sprayer
- also sprays upside down

Take care when using biocides. Always read the label and product information before use!

Ref. no.	Contents			€
29892	100 ml / Pump Spray	1/24	2.304	
29908	300 ml / Spray bottle	1/6	672	

Active ingredient



Icaridin



BALLISTOL Mosquito Protection Stichfrei

- to combat mosquitoes, ticks, brakes, midges and grass mites, also tropical mosquitoes and biting flies
- nourishes the skin, protects against dehydration and has a cooling effect
- with sunscreen SPF 6 to UV-B radiation
- pleasant fragrance
- dermatologically tested as 'very good'
- max. duration: 8 hours

Take care when using biocides. Always read the label and product information before use!

Ref. no.	Contents	MOQ	Pieces / unit			€
291183	20 ml / Pump Spray	16 pieces	16 / display	1/16	1.888	
29852	100 ml / Pump Spray			1/12	2.800	

Active ingredient

Icaridin



Pharmaka supplementary feed



1 Delicious Cubes Original

• instead of sugar as a reward • with glucose, valuable trace elements and many vitamins • a treat for horses and ponies as a reward • makes educational sense • the recipe is developed to suit the horse in terms of flavour

Ref. no.	Contents		€
32500	1 kg / Pouch	1/20	
32501	3 kg / Pouch	1/5	

2 Delicious Cubes with Banana

• Horses love bananas • a substantial „thank you“ for your horse

Ref. no.	Contents		€
32569	1 kg / Pouch	1/20	

3 Delicious Cubes with Herbs

• for the prevention of nutritional deficiencies • contains herbs that, according to experience, have a positive effect on the digestive organs and mucous membranes • 48 h waiting period according to ADMR

Ref. no.	Contents		€
32571	1 kg / Pouch	1/20	

Always provide feed and/or water with supplementary feed!

4 Delicious Cubes with Apple

• the apple flavour completes our extensive range of treats

Ref. no.	Contents		€
32577	1 kg / Pouch	1/20	

5 Delicious Cubes with Carrot

• tastes great • contains beta-carotene, which is turned into vitamin A by the horse • the healthy way to reward your horse

Ref. no.	Contents		€
32579	1 kg / Pouch	1/20	

6 Linseed Plus

• contained gold-pressed grape seed oil, especially rich in antioxidant OPC. • rich in linoleic and linolenic acid • strengthens and relaxes muscles • promotes metabolism and digestion • gives the fur a silky gloss • supports the growth phase

Ref. no.	Contents		€
32574	1000 ml / Bottle	1/6	

Delizia® Treat Cube GrainFree

The grain-free reward for your beloved animal that not only tastes good, but does them good, too!

- with natural levels of minerals and vitamins
- very low sugar and starch content
- 100 % natural Ingredients
- no artificial additives



The grain-free reward!

Ref. no.	Flavour	Contents		€
3297688	Herbs	1 kg / Pouch	1/12	
3297689	Herbs	3 kg / Bucket	1	
3297690	Apple	1 kg / Pouch	1/12	
3297691	Apple	3 kg / Bucket	1	

Delizia® Treat Cube Classic

The healthy treat for your horse – tasty and natural!

- made from premium-quality grain with natural mineral and vitamin content
- available in different flavours



The delicious treat!

Ref. no.	Flavour	Contents		€
325131	Carrot	1 kg / Pouch	1/12	
325132	Carrot	3 kg / Bucket	1	
325005	Banana	1 kg / Pouch	1/12	
325006	Banana	3 kg / Bucket	1	
325007	Apple	1 kg / Pouch	1/12	
325008	Apple	3 kg / Bucket	1	
325009	Raspberry	1 kg / Pouch	1/12	
325010	Raspberry	3 kg / Bucket	1	
325017	Liquorice	1 kg / Pouch	1/12	
325018	Liquorice	3 kg / Bucket	1	
325057	Strawberry	1 kg / Pouch	1/12	
325058	Strawberry	3 kg / Bucket	1	
325123	Vanilla / Cherry	1 kg / Pouch	1/12	
325124	Vanilla / Cherry	3 kg / Bucket	1	



Delizia® Candy

- a special treat for horses • a real taste sensation with fruits and suitable herbs • high-quality and natural ingredients pamper your horse • enriched with essential vitamins and minerals



Ref. no.	Flavour	Contents		€
3227335	Honey / Mango	600 g / Pouch	1/20	
3227336	Strawberry / Mint	600 g / Pouch	1/20	
3227337	Apple / Cinnamon	600 g / Pouch	1/20	

Delizia® Horse Lick Bronchial

Mineral, vitamin and trace element mix with herbs for the total care of your horse.

- idea for use in the pasture, paddock or stable
- additional provision of mineral feed or mineralised concentrate is not necessary
- the herbs included are beneficial and have a freeing effect on the entire respiratory system, strengthening resistance in a natural way
- packed in a food-safe feeding tub which can be re-used afterwards



Feeding recommendation:
300 g per animal per day

Ref. no.	Contents		€
325125	6 kg	1	

Delizia® Pellets MultiVital

Supplementary feed for horses

- support and optimise the circulation, metabolism, fertility and growth • containing organic mineral complexes • supports the entire organism's vital resistance • improves the horse's wellbeing and performance • with vitamins A, D3, E, C, B1, B2, B6, B12 – nicotinic, folic and pantothenic acid and essential trace elements such as biotin, iron, zinc, iodine etc.

Feeding recommendation:
10 - 20 g per day per 100 kg body weight

Ref. no.	Contents		€
325121	4 kg / Bucket	1	



Delizia® Biotin Pellets

Supplementary feed for horses

- the pellet form prevents the animals from blowing them out when eating
- improves hoof growth and hoof strength
- promotes the elasticity of the hooves
- increases skin's resistance and helps the coat's metabolism
- with 2500 mg/kg biotin

Feeding recommendation:

- Foals and ponies: 10 g / day (1/2 scoop), light horses: 20 g / day (1 scoop), heavy horses: 25 g / day (1 1/4 scoop)
- Regular dosing can e.g. help in Cushings, shedding or summer eczema and with hoof problems such as navicular issues, cracked heels or thrush.

Ref. no.	Contents		€
3297685	1 kg / Can	1/6	



Delizia® Flaxseed Oil LinoPur

Straight feed for horses

- natural, cold-pressed linseed oil, all important nutrients are retained
- rich in energy and high quality
- contains natural essential fatty acids and vitamins
- extremely well digested
- suitable for high-performance horses, heavy-footed and older horses, brood mares and horses with digestive problems and allergies

Feeding recommendation:

- Mix in 50 - 150 ml per day with the concentrated feed depending on the horse's needs and weight.

Ref. no.	Contents		€
325119	1000 ml / Bottle	12	
3229057	5000 ml / Canister	1/4	



Delizia® Milk Thistle Oil

Straight feed for horses

- natural, cold-pressed safflower oil, all important nutrients are retained
- the highest content of essential polyunsaturated fatty acids
- stimulating influence on growth and fertility and strengthens the immune system
- high content of vitamins, provitamins and minerals

Feeding recommendation:

- Mix in 50 - 150 ml per day with the concentrated feed depending on the horse's needs and weight.
- You will notice the initial effects after around 10 days, which will subsequently increase.

Ref. no.	Contents		€
3297692	1000 ml / Bottle	1/12	



Delizia® Lick Stone MiniSalick

Healthy occupation in the form of a mineral lick with sea salt and in different flavours. Fits perfectly in the Delizia lick holder for ideal attachment in horse boxes or pastures.

- the ideal occupation for horses in stables and pastures
- can counteract vices such as head banging, walking in circles etc.
- with sea salt, selected trace elements and vitamins
- the lick stone can be easily attached with the halter



with valuable sea salt, minerals and vitamins

Ref. no.	Flavour	Single weight		€
3224538	Apple	700 g	1/12	
3224539	Banana	700 g	1/12	

Ref. no.	Description	Colour	Ø		€
3226314	Delizia® Lick holder round	green	7,5 cm	1/20	

Delizia® Sandwich

The healthy horse nibbles based on meadow grasses, herbs, fruit and vegetables are nutritious and a good activity for the animals.

- made from natural ingredients with a high fibre content
- enriched with fruit and vegetables
- ideally suited for a healthy diet due to the low sugar content



Feeding recommendation:

- up to two sandwiches per day and horse

3225359 3225352 3225353

Ref. no.	Flavour	Single weight		€
3228259	Banana	195 g	1/32	
3225352	Carrot	195 g	1/4/32	
3225353	Apple	195 g	1/4/32	

Delizia® Lick holder



- universal lick stone holder for hanging up
- suitable for many occupational materials



Set consisting of: 2 x Retaining Plate, 1 x Connecting Pin, 1 x Hanging Cable with Spring Snap Hook

3226314



Ref. no.	Description	Colour	Ø			€
324792	6-square	green	13 cm	1/20		
3226314	round	green	7,5 cm	1/20	240	

Delizia® Mineral Lick Equisal

The combination of zinc and selenium can help with metabolic disorders, skin and coat problems, brittle hooves, muscle and fertility problems

- consists of highly digestible and high quality food-grade Mediterranean salt
- for the regulation of blood pressure and the acid-base balance
- promotes the responsiveness of muscles and nerves



made from precious Mediterranean salt, selenium and zinc

Ref. no.	Single weight	Contents		€
325671	3 kg	4 pieces / Cardboard	1	

Delizia® Mineral Lick Equisal NoFly

- consists of highly digestible and high quality food-grade Mediterranean salt
- can deter annoying insects such as flies, mosquitoes and fleas
- can promote blood circulation and support the immune system
- promotes the maintenance of a neutral stomach pH
- antioxidant effect through the minerals iron, selenium, zinc, manganese and vitamin E
- can improve digestion and metabolism
- can reduce the stress factor that is triggered by annoying insects

made from precious Mediterranean salt

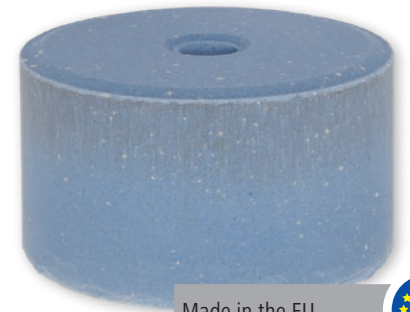

Made in the EU



Ref. no.	Single weight	MOQ	Pieces / unit		€
325670	3 kg	4 pieces	4 / box	1/4	

Delizia® Herbal Lick Equisal DarmoFin

The herbal lick stone with the special herbs for naturally supporting the intestinal environment. Alongside salt and trace elements, herbs with high levels of bitter substances and tannins have a positive effect on the metabolism and general well-being.

- supports a healthy diet with the help of the special blend of herbs
- can help reduce the need for chemical wormer treatments
- supports the metabolism and general well-being
- can help avoid deficiency diseases
- ADMR compliant and not relevant to doping



wild herbs create an intestinal environment that is hostile to worms

- walnut leaves, aspidium, southernwood, coriander, wild garlic, dandelion root

with valuable sea salt and special herbs

Ref. no.	Single weight	MOQ	Pieces / unit		€
3224540	3 kg	4 pieces	4 / box	1/4	

Delizia® Lick stone made from rock crystal salt

- natural salt lick
- contains minerals and trace elements
- with hanging cable



Top Seller

Ref. no.	Single weight		€
325669	1,75 kg	1/12	
321554	2,5 kg	1/6	

This is an entirely natural product and it is made by hand, which is why the actual products may vary in terms of shape and colour from the picture shown.



Delizia® Salt Lick

- pressed Salt Lick
- contains minerals and trace elements
- dimensions approx. 20 x 10 x 5 cm (L x W x H) per lick



Ref. no.	Single weight	MOQ	Pieces / unit		€
324804	2 kg	1 box	4 / box	1	



Lick holder

- practical, virtually indestructible lick holder for angular licks
- incl. reinforced mounting holes
- suitable for 2 kg salt lick (324804) and angular salt or mineral licks of max. 10 x 5 cm
- made of robust plastic
- screw in or nail on



Ref. no.	Colour			€
324803	black	1/60	900	



Lick holder

- no sharp edges
- also suitable for 15 kg salt stones
- Internal dimensions: 191 x 194 mm
- Material: Plastic
- screw in or nail on



Made in the EU



Ref. no.	Colour	Length	Width	Lick Insert			€
324793	black	20,2 cm	20,6 cm	without insert	1	275	
325812	pink	20,2 cm	20,6 cm	without insert	1	275	
325818	royal blue	20,2 cm	20,6 cm	without insert	1	275	

NEW
NEW

Lick holder

- innovative lick holder made from shock-resistant plastic
- for various lick types in round or square shape
- screw-on fastening

32480: with removable insert for round licks up to 3 kg e.g. Equisal

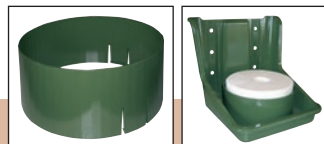

Made in the EU





Ref. no.	Colour	Length	Width	Lick Insert			€
32479	dark green	18,5 cm	19 cm	without insert	1	150	
32480	dark green	18,5 cm	19 cm	with round insert	1	150	

Lick holder

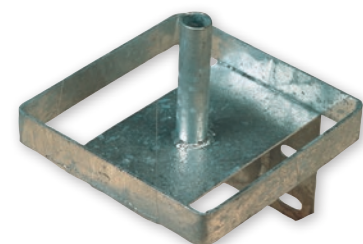
- Material: galvanised metal



Ref. no.	Length	Width	Height			€
32472	20,5 cm	20,5 cm	23,5 cm	1	150	

Feed Ball Toy

- the Food Play Ball must be used only in the stable, pasture, or paddock, and under supervision*
- with 19 feed openings • durable UV-resistant plastic • for up to 3 kg of hay • Filled via 116 mm filling opening with screw cap • can also be hung on a cable or chain • for safe use as an occupation, we recommend hanging attachment using the universal belt (3226434)

3210384: 40 mm feed openings especially suitable for small horses



- Playfully promotes slow and horse-friendly roughage intake

feed opening 60 mm: for large horses
feed opening 40 mm: for small horses

Ref. no.	Colour	Ø	diameter of feed opening		€
3210385	blue	40 cm	60 mm	1	
3210386	red	40 cm	60 mm	1	
3210388	pink	40 cm	60 mm	1	
3210384	purple	40 cm	40 mm	1	

TV

Made in the EU



Ref. no.	Description	Colour	Length		€
3210385-1	Lid for Food Play Ball			1/80	
3226434	Multi-function belt	black	100 cm	1/100	

* If used without supervision, there is a risk that horses are caught by the ball or could otherwise injure themselves.

Feed Ball Toy Soccer

- banishes boredom and promotes active feed intake in a natural feeding position
- wide spacing of the openings ensures safe application • made from sturdy plastic, suitable for use both outdoors and in the box (hanging installation recommended)
- easy to fill thanks to generous opening with screw cap closure • for up to 3 kg of hay • can be attached variably with the multifunctional belt (3226434), e.g. to the divider bars of the box compartment • particularly suitable for long-stalked hay, making it easier to pick up the feed



Ref. no.	Colour	Ø	diameter of feed opening		€
3210445	aquamarine	40 cm	60 mm	1/6	
3210446	rosé	40 cm	60 mm	1/6	

Ref. no.	Description	Colour	Length		€
3226434	Multi-function belt	black	100 cm	1/100	

* If used without supervision, there is a risk that horses are caught by the ball or could otherwise injure themselves.

Multi-function belt

- handy belt for universal use, for hanging things on • also perfect for installing our horse play ball as a hung-up version • made from tearproof, woven material

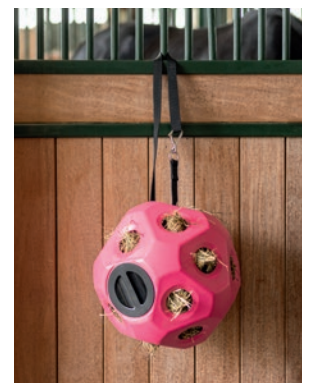

Ref. no.	Colour	Length		€
3226434	black	100 cm	1/100	



Hay Ball Flex

- dispels boredom and encourages slower, stomach-protecting hay intake
- can also be filled with other treats (e.g. carrots)
- including rope (2 m)



New product NEW

Ref. no.	Colour	Material	Ø	Rope length		€
3230297	green	Natural rubber	22 cm	2 m	1/25	
3230298	black	Natural rubber	22 cm	2 m	1/25	

* If used without supervision, there is a risk that horses are caught by the ball or could otherwise injure themselves.

Horse play ball

- the special valve makes the ball refill with air again and again
- extremely bite-resistant for intense horse play
- with apple or mint flavour to increase attractiveness

Ref. no.	Colour	Flavour	Ø		€
32388	green	Apple	25 cm	1/8	
32389	purple	Mint	25 cm	1/8	



Horse play ball

- a great toy that will engross horses
- almost indestructible thanks to resistant yet soft material
- with valve
- Supplied uninflated

Ref. no.	Colour	Ø		€
32398	red	25 cm	1/9	
32399	blue	25 cm	1/9	



Therapy Play Ball for Horses

- can be filled with various treats
- easy installation in a stable or outdoors
- extremely bite-resistant, durable material

Ref. no.	Colour	Ø		€
32390	green	25 cm	1/12	



Horse toy KniStar

- ideal employment material for horses against boredom • high-quality, resistant suede cover • filling made from natural coconut fibres, and integrated plastic bottle
- the flat design with integrated ropes encourages playfulness • with sturdy rope for hanging • easy to attach

New product

NEW



Ref. no.	Description		€
3230299	Fox	1/25	
3230300	Seahorses	1/25	
3230301	Giraffe	1/25	

If there is a strong urge to play, it is possible that the toy will tear.

Horse toy

The natural fibre-filled horse toy with suede cover is a good distraction for horses in the box or during periods where movement is restricted. It is excellent as a means of keeping foals occupied.

- ideal employment material for horses against boredom • high-quality, resistant suede cover • filling made from natural coconut fibres • the flat design with integrated ropes encourages playfulness • with sturdy rope for hanging • easy to attach



Ref. no.	Description	Length		€
3228260	Lama	40 cm	1/25	
3228261	Bear	40 cm	1/25	
3228262	Zebra	40 cm	1/25	

If there is a strong urge to play, it is possible that the toy will tear.



Aesculap Cordless Clipper Bonum Pro

The latest generation of Bonum is given the name suffix Pro for even more professionalism and performance. As before, equipped with lithium ion batteries and an ergonomic, streamlined design that fits perfectly in female hands. The „Pro“ features a low weight, as before, low noise and a long battery life. The Bonum Pro is fitted with an intelligent lithium ion battery system. On the one hand, the battery technology protects the device from overheating and switches it off until it has cooled when the battery temperature reaches >50°C. On the other hand, the charger provides information on the battery status with two LED displays.

- just 40 mm diameter or 12.5 cm circumference in the grip area
- very short and handy at 295 mm in length
- very well balanced and lightweight
- Powerful and long-lasting
- electronic push button recessed in the housing means no more accidental switching the machine on or off when handling

Made in Germany



New product NEW

Now Pro: more powerful motor • new battery management

Included in delivery: 1 x cordless clippers Bonum, Li-ion Battery (GT651), 1 x charger, 1 x power pack with interchangeable plug (EU, UK, US, AUS), 1 x shearing blade set, 1 x Aesculap oil (GT604), 1 x instruction manual, 1 x Durable plastic case



Technical data	
Voltage	10,8 V
Blade set system	Shearing Blade Set
Drive	DC motor
Drive	Spur gear
Stroke rate	approx. 2.500 strokes/min
Battery technology	Li-Ion
Battery voltage	10,8 V
Battery capacity	2.500 mAh
Battery run time	130 min
Battery charge time	65 min
Sound pressure level	65 dB (A)
Dimensions	29,5 cm x 7,5 cm x 7,8 cm
Weight	920 g incl. battery and blade set



available from: March 2025

Ref. no.	Description	Colour	Teeth lower/upper blade	Shearing type			€
GT654-NB	incl. 1 battery and shearing blade set (GT502, GT505)	blue	31 / 23	Fine Horse Shearing	1/6		96
GT654-WT1	incl. 1 battery and shearing blade set (GT502, GT505)	Design edition	31 / 23	Fine Horse Shearing	1/6		96
GT656-NB	incl. 2 batteries and shearing blade set (GT502, GT505)	blue	31 / 23	Fine Horse Shearing	1/6		96
GT656-WT1	incl. 2 batteries and shearing blade set (GT502, GT505)	Design edition	31 / 23	Fine Horse Shearing	1/6		96

Ref. no.	Description	Weight	Lower blade teeth	Upper blade teeth	capacity of battery	Cutting length		€
GT146	Aesculap Precision Adjustment Tool for Cattle / Horse Clippers Torqui						1/100	
GT516	Aesculap Shearing blades Econom Shearing Blade Set		21	23		3 mm	1/10/100	NEW
GT517	Aesculap Shearing blades Econom Shearing Blade Set		31	15		3 mm	1/100	NEW
GT519	Aesculap Shearing blades Econom Shearing Blade Set		31	23		3 mm	1/100	NEW
GT651	Spare battery	210 g			2.500 mAh		1/14	

Aesculap Cordless Clipper Econom CL

The cordless version of the Econom boasts unlimited clipping, perfect balance and exceptional cutting results.

- high shearing speed due to high number of strokes
- glides well thanks to high-power motor
- low heat thanks to high air throughput
- ergonomic handling thanks to slim housing and balanced weight distribution
- tool-free filter change
- uniform and long-lasting cut quality thanks to low-wear shearing blades
- shearing blades made from abrasion-resistant carbon steel can be repeatedly reground

Made in Germany



Included in delivery: 1 x cordless clippers Econom CL, 1 x charging station (GT833), + Li-ion battery (GT831), 1 x upper blade, 1 x lower blade, 1 x Aesculap oil (GT604), 1 x instruction manual, 1 x Durable plastic case

Technical data	
Voltage	21,6 V
Blade set system	Shearing Blade Set
Drive	EC motor
Drive	Spur gear
Battery technology	Li-Ion
Battery capacity	3.350 mAh
Battery run time	90 min
Battery charge time	80 min
Sound pressure level	70 dB
Weight	1.250 g incl. battery and blade set

Intelligent battery technology: provides exactly as much power as needed and switches to „standby“ mode after 1 h of inactivity (increases the lifespan of the battery).



Ref. no.	Description	Colour	Teeth lower/upper blade	Stroke rate	Shearing type		€
GT804	incl. 1 battery and shearing blade set (GT502, GT501)	blue	31 / 15	approx. 2.750 strokes/min	Cattle Shearing, Horse Shearing	1/6	
GT806	incl. 2 batteries and shearing blade set (GT502, GT501)	blue	31 / 15	approx. 2.750 strokes/min	Cattle Shearing, Horse Shearing	1/6	

Ref. no.	Description	Lower blade teeth	Upper blade teeth	capacity of battery	Cutting length		€
GT146	Aesculap Precision Adjustment Tool for Cattle / Horse Clippers Torqui					1/100	
GT367	blade set incl. shearing blade set (GT502, GT501)					1/12	
GT516	Aesculap Shearing blades Econom Shearing Blade Set	21	23		3 mm	1/10/100	NEW
GT517	Aesculap Shearing blades Econom Shearing Blade Set	31	15		3 mm	1/100	NEW
GT519	Aesculap Shearing blades Econom Shearing Blade Set	31	23		3 mm	1/100	NEW
GT831	Spare battery Econom CL			3.350 mAh		1/14	



Aesculap Clipper Econom II

Professional Large Animal Clippers

Made in Germany



- the Aesculap motor, which was developed and produced in Germany, can overcome any coat obstacle, no matter how large, and allows the machine to glide consistently through the coat
- high shearing speed due to high number of strokes
- glides well thanks to high-power motor
- low heat thanks to high air throughput
- ergonomic handling thanks to slim housing and balanced weight distribution
- service-friendly design
- tool-free filter changes – easy carbon replacement – plug-in plate
- integrated electronic start control and overload protection
- uniform and long-lasting cut quality thanks to low-wear shearing blades
- shearing blades made from abrasion-resistant carbon steel can be repeatedly reground



Included in delivery: 1 x clipper Econom II, 1 x upper blade, 1 x lower blade, 1 x Aesculap oil (GT604), 1 x instruction manual, 1 x Durable plastic case

Technical data	
Voltage	230 V AC
Mains frequency	50 - 60 Hz
Output	200 W DC
Blade set system	Shearing Blade Set
Drive	DC motor
Drive	Spur gear
Stroke rate	approx. 2.750 strokes/min
Sound pressure level	73 dB
Cable length	5 m
Weight	1.200 g without cable
Protection class	II



Permanent Magnet System: 200 Watt DC = 400 Watt AC

Ref. no.	Description	Colour	Teeth lower/upper blade	Shearing type			€
GT474	incl. shearing blade set (GT502, GT501)	blue	31 / 15	Cattle Shearing, Horse Shearing	1/6	54	

Ref. no.	Description	Lower blade teeth	Upper blade teeth	Cutting length		€	
GT146	Aesculap Precision Adjustment Tool for Cattle / Horse Clippers Torqui				1/100		
GT516	Aesculap Shearing blades Econom Shearing Blade Set	21	23	3 mm	1/10/100		NEW
GT517	Aesculap Shearing blades Econom Shearing Blade Set	31	15	3 mm	1/100		NEW
GT519	Aesculap Shearing blades Econom Shearing Blade Set	31	23	3 mm	1/100		NEW

Aesculap Shearing blades Econom

- very long service life thanks to wear-resistant carbon steel
- cutting surfaces can be reground very often
- resistant surface coating
- ideal hardness thanks to vacuum hardening process
- made on CNC machines, producing consistently high level of quality

Made in Germany



Upper blade



GT501



GT505



GT503

Lower blade



GT502 3,0 mm



GT504 3,0 mm



GT507 3,0 mm



GT508 0,1 mm



GT511 1,0 mm



GT510 5,0 mm



GT506 3,0 mm

Ref. no.	Description	Upper blade teeth	Lower blade teeth	Cutting length		€
GT517	Shearing Blade Set	15	31	3 mm	1/100	NEW NEW NEW
GT518	Shearing Blade Set	15	31	1 mm	1/100	
GT519	Shearing Blade Set	23	31	3 mm	1/100	
GT501	Upper blade	15			1/10/100	
GT502	Lower blade		31	3 mm	1/10/100	
GT503	Upper blade	17			1/10/100	
GT504	Lower blade		18	3 mm	1/10/100	
GT505	Upper blade all-round shear	23			1/10/100	
GT506	Lower blade		23	3 mm	1/10/100	
GT507	Lower blade		21	3 mm	1/10/100	
GT508	Lower blade		51	0,1 mm	1/10/100	
GT510	Lower blade		24	5 mm	1/10/100	
GT511	Lower blade		31	1 mm	1/10/100	

Combination	Shearing Blade Set	Upper blade	Lower blade	Teeth	Suitable for
finely serrated	GT517	GT501	GT502	15 / 31	cattle and horses standard cut 3 mm
finely serrated	GT518	GT501	GT511	15 / 31	cattle and horses, close shear 1 mm
finely serrated	GT519	GT505	GT502	23 / 31	cattle and horses – for smooth standard cut 3 mm
finely serrated		GT505	GT508	23 / 51	Horse and veterinary shearing
finely serrated		GT505GT505	GT511	23 / 31	Horse and veterinary clipping, close-to-skin clipping 1 mm
medium serrated		GT505	GT510	23 / 24	horses with Cushing's syndrome, dogs and goats 5 mm

Aesculap Precision Adjustment Tool for Cattle / Horse Clippers Torqui

Every Econom cutter head is child's play to adjust with this torque key.

- precise basic adjustment of the shearing blade pressure
- increased blade set life thanks to longer intervals between regrinding
- consistent edge-retention
- easy to handle
- no prior knowledge needed
- small, easy to handle, maintenance-free
- precision instrument engineered in Germany
- suitable for all Econom cattle and horse cutter heads
- all Econom cutter heads can be retrofitted with the knurled screw GT147



GT146

GT147



Ref. no.		€
GT146	1/100	



For the perfect shearing blade pressure!
If required, the thumbscrew can be adjusted by up to half a turn.

Ref. no.	Description		€
GT147	Aesculap Knurled screw for Torqui	1/500	

Shearing Blade Set Premium

• Optimised blade geometry with hollowed grinding • Improved grinding capacity and increased material service life for long periods of use • Selected steel tool with special hardening • suitable for constanta, FarmClipper and other common brands, such as Heiniger, Aesculap and Liscop

Made in Germany



made by Aesculap



Ref. no.	Description	Upper blade teeth	Lower blade teeth	Residual hair length	Shearing type	MOQ	Pieces / unit		€
18955	Cow	23	21	2 - 4 mm	All-round Cattle Shearing, extremely dirty animals	1 pack	1 / pack	1/100	
18959	Cow	17	18	2 - 4 mm	fine-wool sheep shearing, Cattle Shearing	1 pack	1 / pack	1/100	
18956	Cattle / Horse	15	31	2 - 4 mm	slightly dirty animals, Horse Shearing, Cattle Shearing	1 pack	1 / pack	1/100	
18957	Cattle / Horse	23	31	2 - 4 mm	Udder Clipping, Fine cut	1 pack	1 / pack	1/100	
18958	Horses	15	31	1 - 2 mm	Fine cut, skin-level, for vets	1 pack	1 / pack	1/100	

Shearing Blade Set constanta



18914
Shearing blade set R2 Standard-Fine Shear



18915
Shearing blade set R6 Coarse Shear, extremely thick fur



18916
Shearing blade set R22 Close Cut approx. 0.5 mm

Ref. no.	Description	Upper blade teeth	Lower blade teeth	Shearing type		€
18914	R2	24	35	Standard detail clipper	1/50	
18915	R6	24	18	Coarse shearing	1/50	
18916	R22	24	35	Fine cut, skin-level	1/50	

Shearing template

- reusable and washable
- made of high-grade plastic
- for shearing, brushing and spraying



Ref. no.	MOQ	Pieces / unit		€
321900	1 pack	3 / pack	1/100	

Cordless Clipper FarmClipper Akku2

The battery-powered clipper designed for horses or cattle boasts exceptional value for money! The supplied package includes two 14.4 Volt Lithium ion block batteries, which allow uninterrupted shearing thanks to their optimised operating and charging times. The ergonomic characteristics of the FarmClipper Akku2 are also plain to see: the special surface properties of the housing shells and the balanced centre of gravity prevent the user from tiring too quickly. The size of the plastic shells also means that even small hands can be sure of a firm grip on the clipper. The FarmClipper Akku2 is a clipper with fantastic all-round properties boasting excellent handling.

- special, non-slip housing shell for low-fatigue work
- balanced centre of gravity ensures effortless shearing

Included in delivery: 1 x clipper FarmClipper Akku2, 1 x shearing blade set, 2 x batteries 14.4 Volt, 1 x small oil bottle, 1 x screwdriver, 1 x charging station, 1 x instruction manual, 1 x Durable plastic case

Technical data	
Voltage	14,4 V
Stroke rate	approx. 2.300 strokes/min
Battery technology	Li-Ion
Battery voltage	14,4 V
Battery capacity	2.500 mAh
Battery run time	120 min
Battery charge time	90 min
Dimensions	28,5 cm x 8 cm x 8 cm
Weight	1.090 g incl. battery



2,500 mAh battery for long runtime



Ref. no.	Description	Colour	Teeth lower/upper blade	Shearing type			€
181881	incl. 2 batteries	blue	31 / 15	Horse Shearing	1/3	72	
181891	incl. 2 batteries	blue	21 / 23	Cattle Shearing	1/3	72	

Ref. no.	Description	Lower blade teeth	Upper blade teeth	capacity of battery	MOQ	Pieces / unit		€
18955	Shearing Blade Set Premium Cow	21	23		1 pack	1 / pack	1/100	
18956	Shearing Blade Set Premium Cattle / Horse	31	15		1 pack	1 / pack	1/100	
181912	Spare battery			2.500 mAh			1/57	

Clipper FarmClipper4

- even very dirty animals or matted fur are no obstacle to the new FarmClipper4 • universal shearing machine for cattle and horses • optimised weight distribution for low-fatigue working
- attractive, ergonomic design • powerful motor delivering 200 Watt DC

Technical data		18192
Voltage		220 - 240 V AC
Mains frequency		50 - 60 Hz
Output		200 W
Blade set system		Shearing Blade Set
Drive		DC motor
Stroke rate		approx. 3.000 strokes/min
Sound pressure level		85 dB
Dimensions		29,5 cm x 8 cm x 6,2 cm
Weight		1.190 g without cable
Protection class		II



Permanent Magnet System: 200 Watt DC = 400 Watt AC

Included in delivery: 1 x clipper FarmClipper4, 1 x shearing blade set, 1 x screwdriver, 1 x instruction manual, 1 x Durable plastic case

Ref. no.	Colour	Teeth lower/upper blade	Shearing type			€
18192	blue	31 / 15	All-round cut	1/3	108	

Ref. no.	Description	Lower blade teeth	Upper blade teeth		€
18956	Shearing Blade Set Premium Cattle / Horse	31	15	1/100	



Aesculap Cordless Clipper Favorita CLi

Latest generation of cordless Favorita

THE innovative and familiarly powerful cordless clipper for professional use! The integrated „InfoLED Display“ shows the battery charge status as well as oil and cleaning instructions at any time.

- incl. Favorita InfoLED: always informed about the operating status of battery and device!
- enormous cutting power with 3,300 strokes, thanks to high-quality brushless motor
- Li-ion battery of the latest technology guarantees extremely long operating times compared to the previous model
- ergonomic and perfectly balanced
- weight of only 390 g for fatigue-free working
- charging station with LED display and charging bays for machine and spare battery
- Supplied without blade set



Favorita: the unique small animal clipper with adjustable shearing blade pressure and digital InfoLED display!



Set includes: 1 x cordless clippers Favorita CLi, 1 x Aesculap oil (GT604), 1 x instruction manual, 1 x charging station, 1 x power pack with interchangeable plug (EU, UK, US, AUS), depending on the model: 1 or 2 x Li-ion batteries

Technical data	
Blade set system	Aesculap Favorita
Drive	brushless EC motor
Drive	Rocker arm/eccentric
Stroke rate	approx. 3.300 strokes/min
Battery technology	Li-Ion
Battery capacity	2.850 mAh
Battery run time	180 min
Battery charge time	240 min
Sound pressure level	63 dB
Weight	390 g incl. battery and blade set

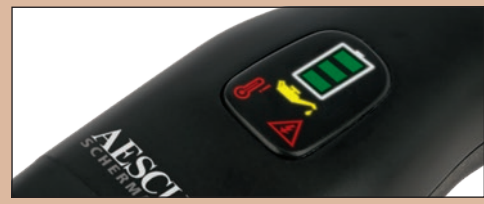

Favorita InfoLED:

- shows the battery charge status on contact when required - even when switched off
- situational warning in the form of an oil can when the time interval for oiling is exceeded
- situational warning if the control registers a problem, e.g. due to overheating

Ref. no.	Description	Colour			€
GT234-NB	incl. 1 battery	blue	1/9	81	
GT234-SR	incl. 1 battery	red	1/9	81	
GT234-TM	incl. 1 battery	pink	1/9	81	
GT236-NB	incl. 2 batteries	blue	1/9	81	
GT236-SR	incl. 2 batteries	red	1/9	81	
GT236-TM	incl. 2 batteries	pink	1/9	81	



NEW

NEW

Ref. no.	Description	capacity of battery		€
XT431	Spare battery	2.850 mAh	1/20	



Aesculap Clipper Favorita II

Powerful and quiet, reliable and sturdy, developed for daily use – the machine for professionals.

- low-vibration operation • proprietary, bearing-mounted Aesculap motor - Made in Germany - powerful and very long-lasting • consistently good cutting results – wear-resistant metal rocker arm • suitable for continuous operation – well-tuned ventilation system and easy-clean air filter protect against overheating and ensure a long life • low-fatigue working thanks to the slim, ergonomically designed housing made from unbreakable specialist plastic • comfortable to use – switch at the front of the machine for comfortable one-handed operation • Supplied without blade set

Made in Germany



Technical data	
Voltage	230 V
Output	35 W
Blade set system	Aesculap Favorita
Drive	Universal
Drive	Worm wheel
Stroke rate	approx. 2.300 strokes/min
Sound pressure level	70 dB
Cable length	5 m
Weight	650 g without cable
Protection class	II

Included in delivery: 1 x clipper Favorita, 1 x Aesculap oil (GT604), 1 x instruction manual, 1 x Durable plastic case

Ref. no.	Colour			€
GT104	red	1/8	72	



Ref. no.	Description		€
GT142	Aesculap Precision Adjusting Aid Torqui Favorita	1/100	

Aesculap Clipper Favorita SPEED

Powerful and quiet, reliable and sturdy, developed for daily use – the machine for professionals.

- low-vibration operation • proprietary, bearing-mounted Aesculap motor - Made in Germany - powerful and very long-lasting • consistently good cutting results – wear-resistant metal rocker arm • suitable for continuous operation – well-tuned ventilation system and easy-clean air filter protect against overheating and ensure a long life • low-fatigue working thanks to the slim, ergonomically designed housing made from unbreakable specialist plastic • comfortable to use – switch at the front of the machine for comfortable one-handed operation • Supplied without blade set

Made in Germany



Included in delivery: 1 x clipper Favorita, 1 x Aesculap oil (GT604), 1 x instruction manual, 1 x Durable plastic case

Technical data	
Voltage	230 V
Output	35 W
Blade set system	Aesculap Favorita
Drive	Universal
Drive	Worm wheel
Stroke rate	approx. 3.000 strokes/min
Sound pressure level	70 dB
Cable length	5 m
Weight	650 g without cable
Protection class	II

The Favorita SPEED GT114 can handle all challenging types of coats due to its high stroke rate! Faster working thanks to more strokes = time saving.

Ref. no.	Colour			€
GT114	red	1/8	72	



Ref. no.	Description		€
GT142	Aesculap Precision Adjusting Aid Torqui Favorita	1/100	



Aesculap Precision Adjusting Aid Torqui Favorita

Every Favorita blade set is child's play to adjust with this torque key.

- precise basic adjustment of the shearing blade pressure
- increased blade set life thanks to longer intervals between regrinding
- consistent edge-retention
- easy to handle
- no prior knowledge needed
- small, easy to handle, maintenance-free
- precision instrument engineered in Germany
- compatible with all Favorita blade sets
- all Favorita blade sets can be retrofitted with an appropriate knurled screw



Ref. no.	€
GT142	1/100



For the perfect shearing blade pressure!
If required, the thumbscrew can be adjusted by up to half a turn.



Ref. no.	Description	MOQ	Pieces / unit	€
GT143	Knurled screw for Torqui Favorita	1 pack	5 / pack	1

Aesculap Blade set with DLC coating Favorita

The Aesculap „Diamond-like Carbon“ (DLC) coating perfectly combines the property profiles of diamond- and PTFE-based surface enhancement. This special coating guarantees outstanding product properties:

- high wear protection and longer service life
- excellent gliding thanks to minimised frictional resistance
- extended edge retention
- increased corrosion protection
- reduced care requirement thanks to dirt-repellent surface



The advantages of the Favorita system naturally also apply to these blade sets with DLC coating.

Ref. no.	Cutting length	Cutting width	€
GH700D	0,05 mm	40 mm	1/10/100
GH703D	0,1 mm	40 mm	1/10/100
GT754D	3 mm	40 mm	1/10/100
GT758D	5 mm	40 mm	1/10/100
GT770D	7 mm	40 mm	1/10/100
GT779D	9 mm	40 mm	1/10/100



Aesculap blade set Favorita

Precision from the pro for the pro!

Blade sets from Aesculap Schermaschinen are precision parts with a claim to perfection. The blade set determines the performance of every clipper. The Favorita blade sets from the metal forge in Suhl/Thuringia are genuine „Made-in-Germany“ products. Exceptionally high-quality cutting tools are manufactured from top-quality carbon blanks in several production stages in accordance with medical technology guidelines. Except for the hardening process, the parts never leave the production facility. This „in-house“ production has only advantages for you:

- unmatched long cutting durability due to first-grade carbon steel
- consistently high cutting capacity of each individual blade set thanks to state-of-the-art CNC grinding and milling equipment
- exceptional coat gliding behaviour due to high-end surface finish
- uniform and clean cutting pattern due to the specially developed tooth geometry
- extremely regrindable, often up to at least 7 times, thanks to the combination of material hardness, quality and manufacturing expertise
- consistent shearing performance thanks to adjustable shearing blade pressure



GH700 0,05 mm



GH703 0,1 mm



GT730 0,5 mm



GT772 0,7 mm



GH712 1 mm



GT736 1 mm



GT746 1,5 mm



GT710 1,8 mm



GH715 2 mm



GT742 2 mm



GT749 2,8 mm



GT748 3 mm



GT754 3 mm



GT758 5 mm



GT770 7 mm



GT779 9 mm

Ref. no.	Cutting length	Cutting width		€
GH700	0,05 mm	40 mm	1/10/100	
GH703	0,1 mm	40 mm	1/10/100	
GT730	0,5 mm	40 mm	1/10/100	
GT772	0,7 mm	20 mm	1/10/100	
GH712	1 mm	40 mm	1/10/100	
GT736	1 mm	40 mm	1/10/100	
GT746	1,5 mm	40 mm	1/10/100	
GT710	1,8 mm	40 mm	1/10/100	
GH715	2 mm	40 mm	1/10/100	
GT742	2 mm	40 mm	1/10/100	
GT749	2,8 mm	60 mm	1/10/100	
GT748	3 mm	40 mm	1/10/100	
GT754	3 mm	40 mm	1/10/100	
GT758	5 mm	40 mm	1/10/100	
GT770	7 mm	40 mm	1/10/100	
GT779	9 mm	40 mm	1/10/100	
GT782	12 mm	40 mm	1/10/100	
GT784	16 mm	40 mm	1/10/100	



GT782 12 mm



GT784 16 mm

The Favorita blade set system with adjustable blade pressure:

- easy cleaning of the upper and lower blades
- better sharpening
- longer life compared to other clipper systems
- super easy blade setting through Torqui GT142



Aesculap Cordless Clipper Durati

This new cordless clipper will win you over with the best price/performance ratio with the proven Aesculap quality. The light, balanced weight paired with the customary, well-engineered Aesculap performance and with simultaneously well-engineered battery run times results in a first class product in the SnapOn segment.

- a high cutting speed via a high stroke rate of 3500 strokes per minute for an optimal cutting results
- powerful rechargeable battery with lithium-ion technology enables very long battery life of up to 4 hours
- powerful, brushless motor for tremendous pulling power
- ergonomically shaped handle area
- fatigue-free operation due to its extremely low weight
- charging station with charging compartments for machine and battery with LED display

Made in Germany



Battery and charging station compatible with Favorita CLi and FAV5 CL

Included in delivery: 1 x cordless clippers Durati, 1 x blade set (GT330), 1 x Aesculap oil (GT604), 1 x power pack with interchangeable plug (EU, UK, US, AUS), 1 x charging station, 1 x instruction manual

Technical data

Blade set system	Aesculap SnapOn, Compatible
Drive	brushless EC motor
Drive	Rocker arm/eccentric
Stroke rate	approx. 3.500 strokes/min
Battery technology	Li-Ion
Battery capacity	2.850 mAh
Battery run time	240 min
Battery charge time	240 min
Sound pressure level	63 dB
Weight	380 g incl. battery and blade set



Ref. no.	Description	Colour			€
GT434-RS	incl. 1 battery and blade set GT330 #10 (1.5 mm)	red / black	1/9	81	
GT436-RS	incl. 2 batteries and blade set GT330 #10 (1.5 mm)	red / black	1/9	81	
GT434-WS	incl. 1 battery and blade set GT330 #10 (1.5 mm)	white / black	1/9	81	
GT436-WS	incl. 2 batteries and blade set GT330 #10 (1.5 mm)	white / black	1/9	81	

Ref. no.	Description	capacity of battery		€
XT431	Spare battery	2.850 mAh	1/20	

Aesculap Cordless Clipper Durati Horse

The Durati with wide blade set #10W for (partial) horse shearing in proven Aesculap quality.

Made in Germany



- high shearing speed for an excellent cut
- powerful rechargeable battery with lithium ion technology
- the compact design also allows shearing in hard-to-reach places
- ergonomically shaped grip area also suitable for petite hands
- fatigue-free operation due to its extremely low weight
- charger with charging compartments for clipper and battery
- with wide blade set #10 W (2.4 mm)



Tip: the battery pack and charging stand are compatible with FAV5 CL Horse (GT334-PR)

Set includes: 1 x cordless clippers Durati Horse, 1 x battery, 1 x blade set #10W (2.4 mm), 1 x Aesculap oil (GT604), 1 x instruction manual, 1 x Durable plastic case, 1 x power pack with interchangeable plug (EU, UK, US, AUS)

Technical data	GT444-BS
Blade set system	Aesculap SnapOn, Compatible
Drive	brushless EC motor
Drive	Rocker arm/eccentric
Stroke rate	approx. 3.500 strokes/min
Battery technology	Li-Ion
Battery capacity	2.850 mAh
Battery run time	240 min
Battery charge time	240 min
Sound pressure level	63 dB
Weight	380 g incl. battery and blade set

Ref. no.	Colour			€
GT444-BS	blue / black	1/6	96	



Ref. no.	Description	capacity of battery	Size	Cutting length		€
GT359	Aesculap blade set SnapOn		10 wide	2,4 mm	1/10/50	
GT387	Aesculap blade set SnapOn		30 wide	0,5 mm	1/10/50	
GT388	Aesculap blade set SnapOn		15 wide	1 mm	1/10/50	
GT389	Aesculap blade set SnapOn		10 F wide	1,5 mm	1/10/50	
XT431	Spare battery	2.850 mAh			1/20	

NEW



Aesculap Cordless Clipper FAV5 CL Horse

The FAV5 CL with wide #10W blade set for (partial) horse shearing in proven Aesculap quality.

Made in Germany



- virtually vibration-free operation thanks to quiet, ball-bearing motor
- consistently good clipping results thanks to wear-resistant metal rocker arms
- well-tuned ventilation system protects against overheating and ensures a long service life
- low-fatigue working thanks to the slim, ergonomically designed housing made from unbreakable specialist plastic
- powerful rechargeable battery with lithium-ion technology enables very long battery life of over 3 hours
- incl. wide blade set GT339 #10 (2.4 mm)



The handy appliance with extremely smooth running!

New product NEW



Included in delivery: 1 x cordless clippers, 1 x blade set GT330 #10 (2.4 mm), 1 x battery, 1 x charging tray, 1 x power pack with interchangeable plug (EU, UK, US, AUS), 1 x Aesculap oil (GT604), 1 x instruction manual, 1 x Durable plastic case

Technical data	
Blade set system	Aesculap SnapOn, Compatible
Drive	DC motor
Drive	Planetary gears
Stroke rate	approx. 2.300 strokes/min
Battery technology	Li-Ion
Battery capacity	2.850 mAh
Battery run time	240 min
Battery charge time	240 min
Sound pressure level	65 dB
Weight	450 g incl. battery and blade set

Ref. no.	Colour			€
GT334-PR	red	1/9	81	

Ref. no.	Description	capacity of battery	Size	Cutting length		€
GT207	Adapter incl. power pack				1/8	
GT359	Aesculap blade set SnapOn		10 wide	2,4 mm	1/10/50	
GT387	Aesculap blade set SnapOn		30 wide	0,5 mm	1/10/50	
GT388	Aesculap blade set SnapOn		15 wide	1 mm	1/10/50	
GT389	Aesculap blade set SnapOn		10 F wide	1,5 mm	1/10/50	
XT431	Spare battery	2.850 mAh			1/20	

NEW

Aesculap blade set SnapOn

Made in Germany



Blade sets from Aesculap Schermaschinen are precision parts with a claim to perfection. The blade set determines the performance of every clipper. The SnapOn blade sets from the metal forge in Suhl/Thuringia are genuine „Made-in-Germany“ products. Exceptionally high-quality cutting tools are manufactured from top-quality carbon blanks in several production stages in accordance with medical technology guidelines. Except for the hardening process, the parts never leave the production facility. This „in-house“ production has only advantages for you:

- unmatched long cutting durability due to first-grade carbon steel
- consistently high cutting capacity of each individual blade set thanks to state-of-the-art CNC grinding and milling equipment
- exceptional coat gliding behaviour due to high-end surface finish
- uniform and clean cutting pattern due to the specially developed tooth geometry
- extremely regrindable, often up to at least 7 times, thanks to the combination of material hardness, quality and manufacturing expertise



Ref. no.	Size	Cutting length	Cutting width		€
GT305	50	0,2 mm	40 mm	1/10/50	
GT310	40	0,25 mm	40 mm	1/10/50	
GT317	30	0,5 mm	40 mm	1/10/50	
GT320	5/8	0,8 mm	20 mm	1/10/50	
GT323	7/8	0,8 mm	20 mm	1/10/50	
GT326	15	1,2 mm	40 mm	1/10/50	
GT330	10	1,5 mm	40 mm	1/10/50	
GT333	9	2 mm	40 mm	1/10/50	
GT341	8 1/2	2,8 mm	40 mm	1/10/50	
GT343	7	3,2 mm	40 mm	1/10/50	

Ref. no.	Size	Cutting length	Cutting width		€
GT345	7 F	3,2 mm	40 mm	1/10/50	
GT357	5	6,3 mm	40 mm	1/10/50	
GT360	5 F	6,3 mm	40 mm	1/10/50	
GT366	4	9,5 mm	40 mm	1/10/50	
GT364	4 F	9,5 mm	40 mm	1/10/50	
GT387	30 wide	0,5 mm	60 mm	1/10/50	
GT388	15 wide	1 mm	60 mm	1/10/50	
GT389	10 F wide	1,5 mm	60 mm	1/10/50	
GT359	10 wide	2,4 mm	60 mm	1/10/50	

NEW



Aesculap Blade Set SnapOn Stainless Steel

Discover our SnapOn blade set made of high-quality stainless steel, which impresses with its elementary material properties and long cutting life. Hygienic, easy to disinfect and with a perfect gliding sensation, it offers an effortless shearing experience.

- high-quality stainless steel with an excellent steel alloy
- easy to clean and very easy to disinfect
- optimum and long-lasting edge retention
- can be re-ground up to 5 times, for long-term use and efficiency



GT305VA 0,2 mm



GT310VA 0,25 mm



GT317VA 0,5 mm



GT330VA 1,5 mm

Not only recommended for vets!

New product NEW

Ref. no.	Size	Cutting length	Cutting width		€
GT305VA	50	0,2 mm	40 mm	1/10/50	
GT310VA	40	0,25 mm	40 mm	1/10/50	
GT317VA	30	0,5 mm	40 mm	1/10/50	
GT330VA	10	1,5 mm	40 mm	1/10/50	

CLIPSTER

Cordless Clipper DeloX

- 3 cutting speeds
- excellent clipping properties thanks to stainless steel blade set
- high-quality, long-lasting motor
- digital display of the charging status, oiling, cleaning and remaining battery capacity
- can also be operated with power pack connected
- with powerful li-ion 2500 mAh battery
- Cutting length adjustment: 5-tier adjustable with setting wheel

Included in delivery: 1 x cordless clippers DeloX, 4 x clip-on combs (3,6, 9, 12 mm), 1 x cleaning brush, 1 x power pack, 1 x charging station, 1 x oil, 1 x instruction manual

Technical data	18463
Voltage	5 V DC
Stroke rate	approx. 4.000 strokes/min / approx. 5.000 strokes/min / approx. 6.000 strokes/min
Battery technology	Li-Ion
Battery capacity	2.500 mAh
Battery run time	300 min
Battery charge time	300 min
Cutting width	38 mm
Cutting length	0,8 mm / 1,1 mm / 1,4 mm / 1,7 mm / 2 mm
Weight	242 g without cable
Protection class	III

Ref. no.	Colour	Shearing type	Cutting width			€
18463	black	Detailed shearing	38 mm	1/6/24	144	

Ref. no.	Description		€
18477	Stainless Steel Blade Set for DeloX	1/670	



	2500 mAh Li-Ion
	38 mm
	0,8 - 2,0 mm
	3 mm 4 x 6 mm 9 mm 12 mm
	Speed
	LED





Cordless Clipper DropiX

- excellent clipping properties thanks to stainless steel blade set
- can also be operated with power pack connected
- with powerful li-ion battery
- Cutting length adjustment: 4-tier adjustable with sliding switch

Included in delivery: 1 x cordless clippers DropiX, 4 x clip-on combs (3,6, 9, 12 mm), 1 x cleaning brush, 1 x power pack, 1 x oil, 1 x instruction manual

Technical data	18461
Voltage	5 V DC
Stroke rate	approx. 6.000 strokes/min
Battery technology	Li-Ion
Battery capacity	600 mAh
Battery run time	60 min
Battery charge time	60 min
Cutting width	38 mm
Cutting length	1 mm / 1,3 mm / 1,6 mm / 1,9 mm
Weight	197 g without cable
Protection class	IPX7
Protection class	III

Ref. no.	Colour	Shearing type	Cutting width			€
18461	silver / black	Detailed shearing	38 mm	1/6/24	144	

Ref. no.	Description		€
18465	Stainless Steel Blade Set for DropiX	1/500	



IPX7 = waterproof

	600 mAh Li-Ion
	38 mm
	1,0 mm 1,3 mm 1,6 mm 1,9 mm
	4 x 3 mm 6 mm 9 mm 12 mm



Cordless Clipper CuttoX

- handy trimmer for detail work
- Clipper head for close cutting (0.3 mm cutting length)
- excellent clipping properties thanks to stainless steel blade set
- can also be operated with power pack connected
- incl. extensive accessories

Included in delivery: 1 x cordless clippers, 1 x blade set, 3 x clip-on combs (3, 6, 9 mm), 1 x cleaning brush, 1 x power pack, 1 x charging tray, 1 x small oil bottle, 1 x instruction manual

Technical data	18459
Voltage	2,4 V DC
Stroke rate	approx. 6.000 strokes/min
Battery technology	NiMh
Battery capacity	800 mAh
Battery run time	60 min
Battery charge time	8 h
Cutting width	27 mm
Cutting length	0,3 mm
Weight	120 g without cable
Protection class	III

Ref. no.	Colour	Shearing type	Cutting width			€
18459	black / silver	Detailed shearing	27 mm	1/6/24	144	

Ref. no.	Description		€
18458	Stainless Steel Blade Set Cuttox	1/300	



	800 mAh Ni-Mh
	27 mm
	0,3 mm
	3 x 3 mm 6 mm 9 mm





Cordless Clipper Sonic

- excellent shearing properties thanks to ceramic blade set
- incl. spare battery for uninterrupted shearing
- can also be operated with charging cable connected
- incl. extensive accessories with 4 clip-on combs for 3, 6, 9 and 12 mm cutting length
- Cutting length adjustment: 5-tier adjustable with setting wheel

Technical data	18265
Output	3 W
Stroke rate	approx. 6.600 strokes/min
Battery technology	NiMh
Battery voltage	2,4 V DC
Battery capacity	1.200 mAh
Battery run time	90 min
Battery charge time	240 min
Cutting length	0,8 mm / 1,1 mm / 1,4 mm / 1,7 mm / 2 mm
Weight	220 g without cable
Protection class	III

Ref. no.	Colour	Shearing type			€
18265	red / black	Detailed shearing	1/20	200	

Ref. no.	Description	Material		€
18181	Spare blade set	Ceramic	1/500	



Cordless Clipper Onyx

- excellent shearing properties thanks to ceramic blade set
- strong battery for long working
- incl. extensive accessories with 4 clip-on combs for 3, 6, 9 and 12 mm cutting length
- Cutting length adjustment: 5-tier adjustable with setting wheel

Included in delivery: 1 x cordless clippers, 1 x blade set, 4 x clip-on combs (3,6, 9, 12 mm), 1 x cleaning brush, 1 x power pack, 1 x charging tray, 1 x oil, 1 x instruction manual

Technical data	18180
Output	3,5 W
Stroke rate	approx. 6.900 strokes/min
Battery technology	NiMh
Battery voltage	3 V DC
Battery capacity	1.200 mAh
Battery run time	90 min
Battery charge time	320 minutes
Cutting length	0,8 mm / 1,1 mm / 1,4 mm / 1,7 mm / 2 mm
Protection class	III

Ref. no.	Colour	Shearing type			€
18180	silver	Detailed shearing	1/20	200	

Ref. no.	Description	Material		€
18181	Spare blade set	Ceramic	1/500	



Clipper A6

The new A6™ product family consists of a number of innovations: New motor concept automatically compensates for voltage fluctuations. This means the motor runs more evenly and with less power consumption! The result: longer motor life! Patent-pending anti-vibration system reduces joint fatigue.

- Compact, 3-level high-performance animal clipper
- with a new high-performance motor with low noise and less heat
- compatible with all Snap-On blade sets
- ergonomic, compact design
- blade set not included
- includes operating instructions

High-performance motor with 3 levels

3 power levels	Insert
Speed level 1	for trimming down to the skin or a thin coat
Speed level 2	for medium-thick coats
Speed level 3	for thick coats

Technical data	
Voltage	230 V
Blade set system	SnapOn
Speed levels	3 speed levels
Speed level 1	3.100 strokes/min
Speed level 2	3.600 strokes/min
Speed level 3	4.100 strokes/min
Cable length	3,66 m
Weight	370 g without cable

Ref. no.	Description	Colour			€
18567	Slim	black	1/6	216	
18547	Slim	Paw Print	1/6	216	

TV



Clipper Golden A5

- The professional clipper with the extra-powerful, smooth-running universal motor
- different snap-on blade sets to choose from
- Shearing blades easy to change over thanks to the snap-on system
- non-slip grip thanks to tread profile
- impact-resistant housing for extreme loads
- air filter can be replaced without tools
- blade set not included
- includes operating instructions

Top Seller

The classic!

Technical data	185552	18555
Voltage	230 V	230 V
Mains frequency	50 - 60 Hz	50 - 60 Hz
Output	45 W	45 W
Blade set system	SnapOn	SnapOn
Speed levels	2 speed levels	1 speed level
Speed level 1	2.200 strokes/min	2.200 strokes/min
Speed level 2	3.300 strokes/min	

Ref. no.	Description	Colour			€
185552	Golden A5 2-speed	claret-red	1/6	216	
18555	Golden A5 1-speed	black	1/6	216	



blade set Cryogen-X

for Golden A5, A6, PowerPro Ultra and PRO3000i

Thanks to a unique cryogenic curing process, these blade sets are on average 15 °C cooler than standard blade sets, making them last longer.

Ref. no.	Size	Cutting length		€
1891900	50	0,2 mm	1/12/48	
1891901	40	0,25 mm	1/12/48	
1891902	30	0,5 mm	1/12/48	
1891903	15	1,2 mm	1/12/48	
1891904	10	1,6 mm	1/12/48	
1891905	7	3,2 mm	1/12/48	
1891906	5	6,3 mm	1/12/48	
1891910	5/8	0,8 mm	1/12/48	
1891913	4	9,5 mm	1/12/48	
1891914	8 1/2	2,8 mm	1/12/48	
1891916	7 F	3,2 mm	1/12/48	
1891917	5 F	6,3 mm	1/12/48	
1891918	4 F	9,5 mm	1/12/48	
1891944	10 wide	2,4 mm	1/12/48	



1891900



1891901



1891902



1891903



1891904



1891905



1891906



1891910



1891913



1891914



1891916



1891917



1891918



1891944

Cordless Clipper Cordless Turbo A5



cordless clipper for the toughest animal use with SnapOn blade set system

- brushless motor with high speed glides even through thick coats without problems
- automatic adaptive motor speed control for constant power transmission, regardless of coat type
- Li-Ion battery pack for up to 80 minutes' runtime at 2900 mAh
- ergonomic, textured handle area for a comfortable and secure grip
- slide switch with easy-grip surface for single-handed operation
- Mains and battery operation supported
- 3-step motor speed: 2800/3200/3600 rpm
- blade set not included

Technical data	18598
Voltage	3,6 V
Drive	DC motor
Stroke rate	approx. 2.800 strokes/min / approx. 3.200 strokes/min / approx. 3.600 strokes/min
Battery technology	Li-Ion
Battery capacity	2.900 mAh
Battery run time	80 min
Battery charge time	150 min
Weight	417 g incl. battery

Included in delivery: 1 x battery-powered clippers without blade set, 1 x charging tray, 1 x mains cable with EU and UK plug, 1 x oil, 1 x cleaning brush, 1 x blade set sleeve, 1 x instruction manual



Ref. no.	Colour		€	Ref. no.	Description	capacity of battery		€
18598	blue	1/4		18605	Spare battery	3.100 mAh	1	

Aesculap BladeCool 2.0

- highly effective, technical spray that immediately cools, lubricates and cleans the blade set
- easy to use: simply spray on before, during and after using the blade set
- improves the cutting result and keeps the shearing blades and blade sets sharp longer
- reliably removes hair and fur residue as well as dirt



Made in Germany



Improved formula with 3 in 1 effect!

Ref. no.	Contents			€
GTA103	400 ml / Spray Can	1/12	1.176	

Clipper Oil

- guarantees optimum lubrication of all moving parts in the blade set
- also ideal for all popular clipper brands



Ref. no.	Contents			€
1850488	100 ml / Bottle	1/50/200	2.400	
1850489	500 ml / Bottle	1/20	600	

CoolSpray

- all-in-one cooling and cleaning
- improves the shearing result and keeps the shearing blades sharp for longer
- reliably removes hair and fur residue as well as dirt



Ref. no.	Contents			€
18952	500 ml / Spray Can	1/12	672	

Aesculap Clipper Oil

Specialist oil for all Aesculap clippers and for all moving parts on and in the blade set.



Ref. no.	Contents		€
GT604	90 ml / Bottle	1/100	





Pivo standard pack

On your smartphone, set up a connection to the extensive Pivo app suite to enable the pod's various functions, including the popular auto-tracking functions. Focus on taking incredible photos, videos, presentations, live streams and more of you and your horse while the Pivo Pod and Pivo App take care of everything else for you.

- the entire set, including tripod and Mini travel case, for transporting the Pivo Pod safely from A to B
- always stay in view with 360° auto-tracking (including face, body and action tracking modes)
- create free-style, adjustable presentations with 4 different presentation modes
- experience video calls in a completely different way: with the Pivo+ app, stay dynamically and engagingly in shot thanks to auto tracking
- user-friendly „Fun Create Modes“: create playful content without any editing knowledge, whether they be GIFs, clone trails, 360 motion time lapses, tiny planets or panoramas - all with just your telephone and Pivo
- content can be uploaded directly from the app without further editing to the preferred live streaming platform and shared
- the compact and long-lasting design makes it easy to take it everywhere with you
- includes remote control for additional convenience and improved interaction
- numerous apps available from the Pivo creator: Pivo +, Pivo Play, Pivo Cast, Pivo Live, Pivo Present



Auto Tracking



4 sec. per Rotation



6 Tracking Speeds



Horse Tracking



Auto Zoom



Video Call

Set includes: 1 x Pivo Pod Active, 1 x intelligent holder (Pivo Smart Mount), 1 x travel case mini (Pivo Travel Case Mini), 1 x tripod (Pivo Tripod), 1 x remote control, 1 x USB charging cable (32 cm)



Extensive accessories which can also be ordered individually:

- 10862 Pivo Smart Mount: holder that can be set, rotated and swivelled for all sizes of mobile phone
- 10863 Pivo Tripod: stable tripod 160 cm tall
- 10864 Pivo Travel Case Mini: perfect transport protection for your Pivo Pod Active
- 10865 Pivo Travel Case Premium: Pivo Pod Active and Tripod perfectly stowed and protected for transport (to be ordered separately)

Ref. no.		€
10861	1/10	



10871



10867



10865

Ref. no.	Description	Colour	Material	capacity of battery		€
10862	Pivo Smart Mount				1/30	
10863	Pivo Tripod	black			1/8	
10864	Pivo Travel Case Mini				1/10	
10865	Pivo Travel Case Premium				1/10	
10867	Pivo Power Bank			9.000 mAh	1/45	
10871	Pivo Tripod Weight	black	Plastic		1/69	

NEW





Pivo Pod Max

Pivo Pod Max is the consistent development of the Pivo Pod series. Pivo Pod Max, in addition to the functions of its „little brother“, offers improved tracking functions and combination with a wider range of devices such as smartphones, tablets, cameras, DSLR and other devices up to 2 kg.

- always stay in view with 360° auto-tracking (including face, body and action tracking modes)
- easy connection from the mobile phone or tablet to the Pivo Pod via Bluetooth
- create free-style, adjustable presentations with 4 different presentation modes
- experience video calls in a completely different way: with the Pivo+ app, stay dynamically and engagingly in shot thanks to auto tracking
- user-friendly „Fun Create Modes“: create playful content without any editing knowledge, whether they be GIFs, clone trails, 360 motion time lapses, tiny planets or panoramas - all with just your telephone and Pivo
- content can be uploaded directly from the app without further editing to the preferred live streaming platform and shared
- the compact and long-lasting design makes it easy to take it everywhere with you
- includes remote control for additional convenience and improved interaction
- numerous apps available from the Pivo creator: Pivo +, Pivo Play, Pivo Cast, Pivo Live, Pivo Present



Pivo+ App

- developed especially for horse tracking and therefore ideal for use during riding activities



Included in delivery: 1 x Pivo Pod Max, 1 x remote control, 1 x USB charging cable (32 cm)

Technical data	
Rotation speed	6 rotation speeds
Weight	366 g
Battery run time	6 - 8 h

Ref. no.	Length	Height		€
10866	95 mm	76,5 mm	1/18	



Ref. no.	Description	Colour	Width	Depth	Height	Weight	capacity of battery		€
10867	Pivo Power Bank						9.000 mAh	1/45	
10868	TravelCase Mini for Pivo Max	black	180 mm	135 mm	110 mm	235 g		1/20	





Pivo Pod Active

On your smartphone, set up a connection to the extensive Pivo app suite to enable the pod's various functions, including the popular auto-tracking functions. Focus on taking incredible photos, videos, presentations, live streams and more of you and your horse while the Pivo Pod and Pivo App take care of everything else for you.

- always stay in view with 360° auto-tracking (including face, body and action tracking modes)
- easy connection from the mobile phone to the Pivo Pod via Bluetooth
- create free-style, adjustable presentations with 4 different presentation modes
- experience video calls in a completely different way: with the Pivo+ app, stay dynamically and engagingly in shot thanks to auto tracking
- user-friendly „Fun Create Modes“: create playful content without any editing knowledge, whether they be GIFs, clone trails, 360 motion time lapses, tiny planets or panoramas - all with just your telephone and Pivo
- content can be uploaded directly from the app without further editing to the preferred live streaming platform and shared
- the compact and long-lasting design makes it easy to take it everywhere with you
- includes remote control for additional convenience and improved interaction
- numerous apps available from the Pivo creator: Pivo +, Pivo Play, Pivo Cast, Pivo Live, Pivo Present

Pivo+ App

- developed especially for horse tracking and therefore ideal for use during riding activities

Included in delivery: 1 x Pivo Pod Active, 1 x remote control, 1 x USB charging cable (32 cm)

Technical data				
Rotation speed	6 rotation speeds			
Weight	176 g			
Battery run time	2 - 3 h			
Ref. no.	Length	Height		€
10860	63 mm	73 mm	1/40	
Ref. no.	Description	capacity of battery		€
10867	Pivo Power Bank	9.000 mAh	1/45	



Pivo Bluetooth Microphone

- multifunctional, ultra-compact, wireless Bluetooth microphone that can be easily clipped on
- ultra-long transmission range of 60 m, Pivo Wireless Mic gives you the freedom to move around freely
- thanks to the latest Bluetooth technology, you always stay connected and enjoy clear sound, even when recording remotely
- Noise cancellation reduces background noise while your voice can be heard clearly - ideal for recording while riding
- Whether you are the teacher or the student, Pivo Wireless Mic is there to help you communicate
- weight of just 22 g

New product

Ref. no.	Colour		€
10872	black	1/63	



Pivo Bracket for Action Cam

- compatible with any smartphone and mobile device, with or without a case
- Clamping bracket can be stretched to a maximum of 8 cm
- high-quality and lightweight product - made of ABS
- with universal clamp - suitable for action cams, e.g. GoPro

New product

Ref. no.	Colour		€
10873	black	1/74	



IPCam SIM FHD

- IP surveillance camera for use with SIM card or wired network connection (LAN) • ideal for use in places where there is no LAN connection or WLAN, e.g. in stables, warehouses or for monitoring pastures • remote control and access anywhere via app or browser, easy installation of the app using the QR code supplied • can be combined with an external solar panel and AGM battery for flexible use in locations without a power supply • 5x optical zoom allows optimised monitoring and the surveillance area can be restricted • Motion detection, tracking and recording • incl. highly sensitive microphone and built-in loudspeaker for remote communication • excellent night vision thanks to four extra powerful LEDs that create daylight conditions within a radius of up to 50 metres • flexible mounting arm for vertical or horizontal mounting

Included in delivery: 1 x IPCam SIM FHD, 1 x 230 Volt power pack, 1 x receiving antenna, 1 x patch cable

Technical data	
Zoom	5x optical zoom
Image Sensor	1/3" CMOS
Video resolution supported	UHD 1296 (2304 x 1296)
Frame rate	25 fps (UHD)
horizontal visible range	355 °
Vertical visible range	95 °
Viewing angle	40 - 120 °
Number of LEDs	4
Night vision range	50 m
Transfer type	3G / 4G / LTE / LAN
Weight	1,33 kg
Voltage	12 V
Output	13 W
Protection class	IP66



Ref. no.	Colour		€
10852	white	1/8	

IPCam 360 FHD Compact

- quick swivelling outdoor IP camera • excellent image quality with 2 megapixels • 50 metre night vision via 6 infrared LEDs • extensive viewing area (pan / tilt / zoom): swivels around 355° horizontally and 90° vertically, adjustable speed • remote control and access worldwide via app or browser, immediate connection using the app via a QR code • WiFi-compatible and ONVIF compliant: compatibility according to an international standard • Motion detection: automatically starts recording on SD(HC/XC) card, notification via email • free app (eyecloud) for iOS and Android • weatherproof aluminium housing • includes operating instructions

Included in delivery: 1 x IPCam 360 FHD Compact, 1 x 230 Volt power pack, 1 x patch cable, 1 x Wi-Fi antenna

Technical data	10825
Zoom	Digital zoom
Image Sensor	2,7 CMOS
Video resolution supported	Full HD 1080 (1920 x 1080) / HD 720 (1280 x 720) / VGA (640 x 480) / QVGA (320 x 240)
Frame rate	15 fps (HD) / 25 fps (VGA)
Panel	f/1,6
horizontal visible range	355 °
Vertical visible range	90 °
Viewing angle	40 - 120 °
Number of LEDs	6
Night vision range	50 m
Transfer type	LAN / WLAN
Weight	1 kg
Voltage	12 V
Output	10 W
Storage capacity	32 GB
Protection class	IP66



supports ONVIF

Ref. no.	Colour	Length	Width	Height		€
10825	black	21 cm	21 cm	12,5 cm	1/10	



IPCam 360 FHD

with 5x optical zoom

- the new hinge can pivot 90 ° and be fixed in place at any point: Ideal positioning on walls, slopes and ceilings for true all-round visibility
- quick swivelling outdoor IP camera with huge field of view (Pan / Tilt / Zoom): swivels horizontally by 355° and vertically by 90°
- excellent image quality with 2 megapixels
- weatherproof aluminium housing
- bright 5x zoom optics
- 50 metre night vision via 6 infrared LEDs
- WDR support (wide dynamic range) for a balanced image of both brighter as well as darker image areas
- remote control and access worldwide via app or browser, immediate connection using the app via a QR code
- WiFi-compatible and ONVIF compliant: compatibility according to an international standard
- free app (eyecLOUD) for iOS and Android
- Motion detection: automatically starts recording on SD(HC/XC) card, notification via email
- includes operating instructions

Included in delivery: 1 x IPCam 360 FHD, 1 x power pack, 1 x Wi-Fi antenna, 1 x patch cable



supports ONVIF

Technical data	10809
Zoom	5x optical zoom
Image Sensor	2,7 CMOS
Video resolution supported	Full HD 1080 (1920 x 1080) / HD 720 (1280 x 720) / VGA (640 x 480) / QVGA (320 x 240)
Frame rate	15 fps (HD) / 25 fps (VGA)
Panel	f/1,6
horizontal visible range	355 °
Vertical visible range	90 °
Viewing angle	40 - 120 °
Number of LEDs	6
Night vision range	50 m
Transfer type	LAN / WLAN
Weight	1,9 kg
Voltage	12 V
Output	10 W
Storage capacity	microSD 32 GB
Protection class	IP66



Ref. no.	Colour	Length	Width	Height		€
10809	black	33 cm	25 cm	14 cm	1/8	



IPCam 2.0 HD

The internet camera for everyone!

- remote control and access worldwide via app or browser, immediate connection using the app via a QR code
- WiFi-compatible and ONVIF compliant: compatibility according to an international standard • free app (eyecloud) for iOS and Android
- motion detection: recording starts automatically, alarm via e-mail, image upload to FTP server
- Recording to microSD(HC/XC) card • weatherproof aluminium housing • includes operating instructions

Included in delivery: 1 x IPCam 2.0 HD, 1 x power pack, 1 x Wi-Fi antenna, 1 x patch cable

Technical data	10810
Zoom	Digital zoom
Image Sensor	1/4" CMOS
Video resolution supported	HD 720 (1280 x 720) / VGA (640 x 480) / QVGA (320 x 240)
Frame rate	15 fps (HD) / 25 fps (VGA)
Viewing angle	60 °
Number of LEDs	30
Night vision range	15 m
Antenna reach	50 m
Weight	620 g
Voltage	12 V
Output	10 W
Storage capacity	microSD 32 GB
Protection class	IP65



supports ONVIF

Ref. no.	Colour	Length	Width	Height		€
10810	black	16 cm	12 cm	8,5 cm	1/10	



SmartCam HD

One camera for many possibilities! When using a Wi-Fi hotspot, the camera can be controlled directly via the smartphone (without an Internet connection). When used as a trailer camera, animals can be monitored directly via an app (UCCAM) on the iPhone or Android mobile phone. The camera has a powerful magnetic holder so that it can be secured flexibly without any drilling or screwing work required. The powerful Li-ion batteries deliver up to 6 h of video enjoyment!

- extensive surveillance options during animal transport • access via various devices (smartphone, PC or tablet)
- sturdy case with IP66 protection class • free app for iOS or Android on smartphones or tablets • night vision function (light sensor, image sensor, as well as IR LEDs) • with magnetic holder
- includes operating instructions

Included in delivery: 1 x SmartCam HD, 1 x power pack, 1 x Wi-Fi antenna

Technical data	10812
Image Sensor	1/4" CMOS
Video resolution supported	HD 720 (1280 x 720)
Viewing angle	100 °
Number of LEDs	14
Night vision range	5 m
Voltage	5 V
Battery run time (with IR-LED)	5 hours
Battery run time (without IR-LED)	8 hours
Rechargeable battery	Li-Ion
Battery capacity	3.000 mAh
Protection class	IP66

Ref. no.	Colour	Length	Width	Height		€
10812	black	8,5 cm	6 cm	5 cm	1/20	



TV

Ref. no.	Description	Colour	Length	suitable for		€
10823	Connector Cable 12 Volt	black	10 m	10812	1/40	
10827	Connector Cable 12 Volt	black	3 m	10812	1	
1083	Antenna with Magnetic Foot	black			1/30	



Solar Set

- incl. charge controller • for direct connection to a 12 Volt battery (e.g. 442064) • 2 m solar cable for flexible installation • incl. 2 m battery connection cable (70618) • optional extension cable set (441600) available for a greater distance between module and battery • Mounting on spiral ground/retaining anchor (442382) or by means of mounting kit (442386) on metal box (44656, 44650)

70601:

- incl. two stainless steel horizontal struts • suitable for mobile power supply, e.g. for the SmartCoop system or IPCam 360 SIM-FHD



Ref. no.	Output solar module	Width	Height	Depth		€
70601	100 W	66,4 cm	100 cm	3,5 cm	1	

Ref. no.	Description	Colour	Length	Width	Height	Weight	capacity of battery	MOQ	Pieces / unit		€
441600	Extension Cable Set		5 m					1 pack	2 / pack	1	
442064	Premium AGM Battery	black	275 mm	175 mm	190 mm	20,7 kg	88 Ah			1	
442382	Spiral Ground/Retaining Anchor				120 cm	8 kg				1	
442386	Metal Box Assembly Kit									1/15	
70618	Battery connection cable		2 m							1/50	
70619	Battery connection cable		8 m							1/18	

Solar Battery Kit

- suitable for mobile power supply • Set consists of solar panel with rechargeable battery and connection cable • high-quality solar panel and a powerful Li-ion battery store sufficient solar energy during the day to ensure power supply at night and on cloudy days • 2.5 m cable between solar panel and battery, plus 2.5 m connection cable allow flexible installation • thanks to the adjustable mounting bracket, the panel can be adjusted perfectly to the incident light, depending on the time of day and season • suitable for outdoor use

70603: Suitable for the supply of power to the SmartCoop control (70600), connectivity module (70620) and door (70640, 70645). A sufficient supply of additional SmartCoop modules is not guaranteed, as it depends on the number of sunny days and the power consumption of the individual modules.

70604: Suitable for the supply of power to the SmartCoop control (70600), connectivity module (70620), door (70640, 70645) and LED coop lighting (70621). A sufficient supply of additional SmartCoop modules is not guaranteed, as it depends on the number of sunny days and the power consumption of the individual modules.

- suitable for mobile power supply to all 12 Volt IP cameras, e.g. 10809, 10825 and 10852

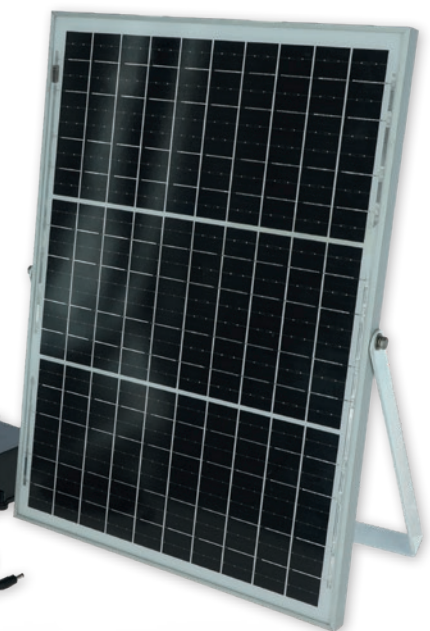

Technical data	
Device voltage	12 V
Output solar module	25 W
capacity of battery	9 Ah
Battery technology	Li-Ion

New product

NEW

Ref. no.	Output solar module	Length	Width	Height		€
70603	25 W	36 cm	52 cm	1,6 cm	1	
70604	40 W	42,5 cm	60 cm	2,4 cm	1	

HK Pregnancy Testers for Horses

You can quickly and reliably detect pregnant mares using the pregnancy tester between the 14th and 38th week after the last mating with over 90 % certainty.

Advantages:

- You can determine when you want the examination to take place
- No previous expertise or major training required
- No unpleasant transrectal examination required for the animal, so no risk of miscarriage
- The device is comfortably worn on the belt, leaving both hands free for measurement
- Robust workmanship in a solid plastic housing
- Automatic shut-off prevents unnecessary energy consumption
- In most cases, the test takes less than 30 seconds
- The housing is protected against moisture ingress
- Secure storage in the supplied case
- 4 x 1.5 V AA (LR6) batteries included



Ref. no.		€
323	1	



Made in Germany



Nebuliser Solution DeadSea Liquid

Dead Sea brine is rich in minerals and trace elements. The natural brine, which is suitable for nebulisers, spatial inhalation, and air humidifying, provides a pleasant climate for horses and riders.

- salt solution made from Dead Sea salt, rich in minerals and trace elements
- natural brine, prepared under the highest hygiene standards
- with magnesium for a de-cramping, relaxing, and soothing effect
- for air humidification, and to enhance the air with beneficial natural salts
- also suitable for use in ultrasonic nebulisers
- water and salt from the Dead Sea - enriched with minerals



Made in Germany



The use of the products should always be coordinated with the attending veterinary surgeon or therapist.

Ref. no.	Concentration	Contents		€
3228283	1 %	1000 ml / Bottle	1/6	
3228284	2,5 %	1000 ml / Bottle	1/6	

Herbal Liquid

Herbal water for humidifying the air

Recommendations for use:

- 1 x daily, mix 10 ml of Herbal Liquid with 30 - 40 ml of sterile 0.9 % saline solution and mist or moisten
- the solution is also suitable for use in ultrasonic nebulisers



Made in Germany



Composition

Water, plant extract (marshmallow, ribwort, sage, watercress, Icelandic moss, liquorice, ivy), NaCl, Potassium sorbate, Citric acid

Ref. no.	Contents		€
3211820	500 ml / Dispenser Bottle	1/14	

Ultrasound Inhaler for Horses AirOne

AirOne sets the standard in equine respiratory treatment and therapy. When inhaled at rest, optimal wetting of the bronchial area is facilitated.

- one of the most effective inhalation devices on the market for decades
- maximum nebuliser output combined with optimal particle size ensures effective inhalation
- very simple operation and almost maintenance-free operation
- splash-proof construction (IP54) and impact-resistant materials ensure safe operation
- transparent horse mark for easy control of correct inhalation
- optimised fit of the mask thanks to soft and flexible rubber seal
- mask is easy to clean thanks to removable valves
- Fault indication in case of low water level or overheating
- permanent operation through 230 Volt operation
- Protection class: IP54
- nebuliser performance up to 15 ml/min and 2-5 ml/ breath
- particle size between 0.5-6 µm
- 2-chamber cold nebulisation



3211802

Includes 3211800 / 3211802: AirOne Nebuliser 230 Volt, elastic connection hose, Wall bracket for Nebuliser, Contact liquid, 30 x nebuliser cups, protective transport container, Operating instructions, 3211802: including inhalation mask with silicone seal for horses, head strap for horses, and disinfection

Made in Germany



Size guide:

Bit size	Mask size
< 11,0 cm	Shetty / foal
11,0 - 12,0 cm	Pony
12,5 - 14,5 cm	warmblood
> 14,5 cm	coldblood



Ref. no.	Description		€
3211802	AirOne incl. Warmblood Mask	1	
3211800	AirOne without Mask	1	

Ref. no.	Description	Contents	Contents		€
3211810	Inhalation Mask incl. Accessories Shetty mask for AirOne			1	
3211861	Inhalation Mask incl. Accessories Pony mask for AirOne			1	
3211807	Inhalation Mask incl. Accessories Warmblood mask for AirOne			1	
3211809	Inhalation Mask incl. Accessories Coldblood mask for AirOne			1	
3211818	Nebuliser cup 30 items			1/75	
3211819	Contact liquid	1.000 ml	1000 ml	1/24	
299310	cit Surface Disinfection Spray Erazer RTU	1.000 ml	1000 ml / Spray bottle	1/12	

Use disinfectants with care. Always read the label and product information before use.



Rubber Tying Rope

- durable elastic tying rope with rotary bull snap and panic release hook
- for various tying needs in stables, wash rooms, trailers etc.
- Breaking load : approx. 350 kg

Ref. no.	Colour	Length		€
3230302	black	40 cm	1/50	
3210370	black	50 cm	1/60	
3230303	black	60 cm	1/50	
3210371	black	70 cm	1/50	
3210372	black	90 cm	1/50	

NEW

NEW



Made in Germany



Tie Strap adjustable

- extremely heavy-duty
- Adjustable length
- with panic snap and carabiner hook

Ref. no.	Colour	Length		€
32089	blue	35 - 90 cm	1/10	

Tether Chain

- chain with plastic coating
- with panic snap and carabiner hook

Ref. no.	Length		€
321414	50 cm	1/30	
321415	70 cm	1/20	
321416	140 cm	1/15	



Tie Strap with Chain

- extremely heavy-duty
- with panic snap and carabiner hook

Ref. no.	Colour	Length		€
32161	blue	70 cm	1/10	

Made in Germany



Rubber Tether Strap

- with sturdy rings

Ref. no.	Colour	Length		€
32835	black	50 cm	1/50	



Rubber Ball Tether Protection

- for protection when tethering the horse, to prevent entangling and biting
- low-noise protection which prevents the fastening hook from striking the wall
- strong, flexible rubber material
- easy to clean

New product

NEW

Ref. no.	Colour		€
3230304	black	1/30	

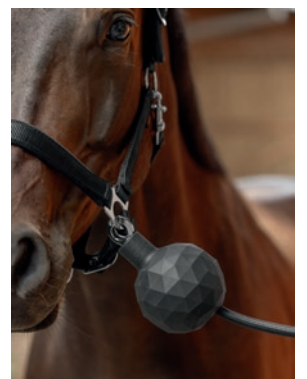

Reins Snap

• for reins up to 20 mm width • Material: galvanised metal

Ref. no.	MOQ	Pieces / unit		€
326140			1/150/600	
326140/2	1 blister pack	2 / blister pack	1	

Tether Ring

• for screwing in to the box or stable wall • sturdy plate with 4 screw holes • Material: galvanised metal

Ref. no.	MOQ	Pieces / unit		€
32163			1/50/100	
32163/1	1 blister pack	1 / blister pack	1	

Panic hook

• for tether ropes • 14 mm eye • Material: galvanised metal

Ref. no.	MOQ	Pieces / unit		€
32149			1/40/160	
32149/1	1 blister pack	1 / blister pack	1	

Spring Hook

• including for lunging attachments and side reins • Material: stainless steel

Ref. no.	MOQ	Pieces / unit		€
32188/2	1 blister pack	2 / blister pack	1	

Snap-hook

• with angular swivel • Material: galvanised metal

Ref. no.	MOQ	Pieces / unit		€
32100/1	1 blister pack	1 / blister pack	1	

Snap-hook

• heavy duty design • Material: brass

Ref. no.	MOQ	Pieces / unit		€
32187			1/10/300	
32187/1	1 blister pack	1 / blister pack	1	

Snap-hook

• heavy duty design • Material: galvanised metal

Ref. no.	Description	MOQ	Pieces / unit		€
12507	with round swivel for chain	10 pieces	10 / pack	1/10/150	
12507/1	with round swivel for chain	1 pack	1 / pack	1	



Top Seller



Saddle Cabinets, Saddle and Bridle Racks

Saddle cabinet

- high-quality saddle cabinet as a construction kit
- with a storage compartment
- with two saddle holders
- hook and holder providing plenty of space for hanging up e.g. snaffles
- with air vent, lockable and stackable
- Material: steel plate, galvanised



326132



32707



Ref. no.	Width	Depth	Height	Weight		€
32707	60 cm	60 cm	106 cm	30 kg	1	
326132	60 cm	60 cm	150 cm	38 kg	1	

Ref. no.	Description	Material		€
32708	Spare Lock with Key	metal	1/50	
32723	Saddle Holder for Saddle Cabinet		1/20	
32724	Bridle Rack for Saddle Cabinet		1/20	
32725	Hanging Hook for Saddle Cabinet		1	



326132



32707

Saddle cabinet attachment

- ideal extension for your Saddle Cabinet!
- with two compartments for even more storage space
- with air vent, lockable and stackable
- Material: steel plate, galvanised



32708

Ref. no.	Width	Depth	Height	Weight			€
32729	60 cm	60 cm	60 cm	18 kg	1	20	

Ref. no.	Description	Material		€
32708	Spare Lock with Key	metal	1/50	



Saddle Cabinets, Saddle and Bridle Racks

Kick pad

- to protect the horse from injuries in the box, on the transporter or in the lorry
- very easy to clean thanks to water-resistant material
- filled with shock-absorbing foam with a thickness of 4 cm
- Edging with reinforced rings for easy attachment to the box wall
- low weight

New product

NEW



Ref. no.	Colour	Length	Width	Height		€
3230533	black	120 cm	100 cm	4 cm	1/3	

Saddle Stand

- durable and stable saddle stand with bridle rack and large storage compartment
- flexible, space-saving and easy to fold up
- suitable for English and Western saddles
- powder coated metal for a long service life



Ref. no.	Colour	Width	Height	Depth			€
3211640	black	46 cm	89 cm	71 cm	1/2	20	



Saddle caddy

- stable saddle carrier made from powder-coated metal tubes
- saddle, bridle and grooming box holder, as well as two hooks
- mobile and foldable
- suitable for stables, tournaments and on the move
- Dimensions of grooming box top and bottom: width 38 cm x depth 28 cm

The following grooming boxes fit into the grooming box frame:



- Siena (321757, 328267, 328268, 321788) • Arrezzo (321747, 321789)
- Roma (321770) • AluSafe (320137)



Ref. no.	Colour	Width	Height	Depth	Weight			€
321000	black	48 cm	127 cm	78 cm	15 kg	1	18	

Western Saddle Holder

- made from sturdy powder-coated metal tubes
- extra-wide rest for Western saddles
- incl. bridle rack hook
- for wall mounting

Ref. no.	Colour	Length			€
32953	black	55 cm	1/10	160	



Saddle Cabinets, Saddle and Bridle Racks

Climbing aid

The folding climbing aid with lock function and non-slip bobbles on the step surface allows comfortable climbing with additional safety.

- space-saving
- integrated carrying handle
- with anti-slip bobbles on the step surface
- made of robust plastic
- Safety closure prevents folding
- load capacity up to 120 kg

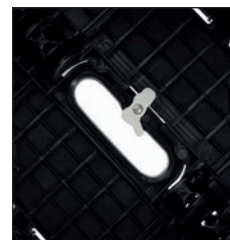

Ref. no.	Colour	Width	Depth	Height		€
3228281	black	36 cm	28 cm	39 cm	1/12	

Helmet storage

- a practical accessory for any rider's den, tack room or just for at home
- easy to assemble
- stable wire frame, powder-coated
- screw-on fastening

Ref. no.	Colour			€
321355	black	1/100	1.200	

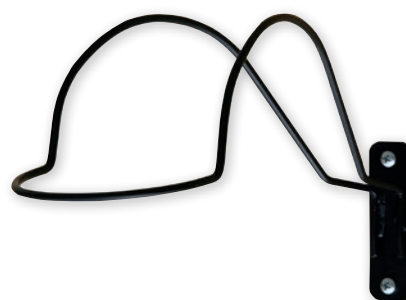

Saddle Holder

- made from sturdy powder-coated metal tubes
- with additional support
- English Model
- screw-on fastening



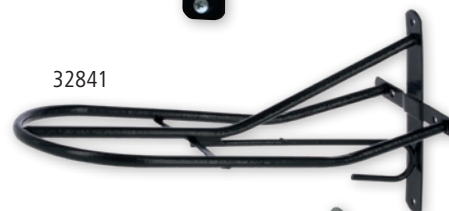

3284



32841



32884



Ref. no.	Colour	Length			€
3284	red	54 cm	1/12	96	
32841	black	54 cm	1/12	96	
32884	grey	54 cm	1/12	96	



Top Seller

Saddle Holder



- round design • with integrated bridle holder • folding • screw-on fastening

Ref. no.	Colour	Length	Material			€
32842	red	44 cm	metal, varnished	1/20	360	
32845	black	44 cm	metal, varnished	1/20	360	



Saddle Holder

- folding • screw-on fastening

Ref. no.	Colour	Length	Material			€
32360	red	38 cm	metal, varnished	1/10/20	840	



Saddle Cabinets, Saddle and Bridle Racks

Saddle Holder with Saddle Cloth Holder

- with integrated saddle pad holder
- made from sturdy powder-coated metal tubes
- English Model
- screw-on fastening
- Length of saddle holder: 40 cm
- Length of saddle pad holder: 60 cm

New product

NEW



Ref. no.	Colour		€
3230305	black	1/10	

Blanket rack

- galvanised chain with two carabiners and plastic coating
- for hanging up horse or saddle blankets



Ref. no.		€
325817	1/25	

Blanket rack

- high quality metal design
- made from sturdy powder-coated metal tubes
- ceiling bracket for stable doors or tack rooms
- with two hooks
- screw-on fastening



Ref. no.	Colour	Length	Width			€
325842	black	91 cm	20 cm	1/10	100	

Blanket Rack, 4-tier

- made from stable powder coated metal rods
- practical and flexible to use
- for hanging up and drying horse or saddle blankets



Ref. no.	Width	Height			€
3297676	60,6 cm	117,5 cm	1/20	300	

Ceiling bracket for hanging

The practical blanket holder for the horse box is very easy to mount and does not require any assembly. It is adjustable in length and has two hooks for accessories.

- with two hooks for easy attachment to the box or stable door
- with two suspension hooks for snaffles, halters etc.
- high-quality design made of metal with powder coating for high durability



Ref. no.	Colour	Length adjustable	Width		€
3228263	black	60 - 94 cm	20 cm	1/10	





Saddle Cabinets, Saddle and Bridle Racks

Blanket and saddle cloth holder

- extra-sturdy design with swivel-mounted brackets for saddle pads and/or saddle and horse blankets
- with 5 saddle cloth clips and 4 horse blanket holders
- made from sturdy powder-coated metal tubes





Ref. no.	Colour			€	
32688	black	1	24		

Ceiling Mount, 3-arm

- sturdy, pivotable ceiling bracket for storing up to 3 horse blankets
- dimensions: small clip approx. 86 x 63 cm, large clip approx. 70 x 95 cm
- made from sturdy powder-coated metal tubes



Ref. no.	Colour			€	
32686	black	1	24		

Bridle Rack

- high quality metal design
- with 4 hooks for hanging halters, bridles etc.
- for hanging



Ref. no.	Colour			€
321362	black	1/10/20	360	



Bridle Rack

- made of high-grade plastic
- for wall mounting



Made in Germany





Ref. no.	Colour			€
324464	black	1/144	1.296	
324465	red	1/144	1.296	

Bridle Rack

- for wall mounting



Ref. no.	Colour	Material			€
32361	red	metal, powder-coated	1/100	2.000	
323615	black	metal, powder-coated	1/100	1.200	
32885	dark grey	metal, powder-coated	1/100	1.200	



Top Seller

Feeding Trough Stainless Steel

- Round trough made from rust-proof stainless steel
- support structure made of galvanised metal for wall mounting
- no sharp corners or edges that can cause injury
- with drain plug 15 mm



Stainless Steel Bowl

Ref. no.	Length	Width	Height	Capacity			€
32490	44 cm	38 cm	23 cm	18 L	1	36	

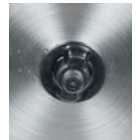

Aluminium feed trough

- extremely light feed trough weighing only approx. 3.5 kg
- Ø 35 cm bowl made of high-quality aluminium
- exceptionally simple cleaning thanks to drainage plugs
- support structure made of galvanised metal
- no sharp corners or edges that can cause injury
- with drain plug



Ref. no.	Description	Length	Width	Height	Ø	Capacity			€
32495	for straight mounting	44 cm	38 cm	23 cm	35 cm	18 L	1	36	
32496	for corner mounting	37 cm	37 cm	24 cm	35 cm	18 L	1	45	

Rectangular Trough

- extremely durable and keeps its shape
- additional protection against injuries due to continuous round tubes
- Material: hot-dip galvanised metal
- with drain plug 15 mm



Ref. no.	Length	Width	Height	Capacity			€
32483	45 cm	34 cm	24 cm	35 L	1	16	

Triangular Trough

- extremely durable and keeps its shape
- additional protection against injuries due to continuous round tubes
- Material: hot-dip galvanised metal
- for corner mounting
- with drain plug 15 mm



Ref. no.	Length	Width	Height	Capacity			€
32482	44 cm	44 cm	24 cm	35 L	1	16	

Round Trough

- extremely durable and keeps its shape
- additional protection against injuries due to continuous round tubes
- Material: hot-dip galvanised metal
- with drain plug 15 mm



Ref. no.	Length	Width	Height	Capacity			€
32484	55 cm	35 cm	24 cm	28 L	1	16	



Feed Troughs and Buckets

Feed Trough Long

for hanging

- especially stable with glass fibre reinforced plastic
- extra-strong loops
- fits plug trays and nearly every device of up to 50 mm size
- Dimensions: Depth 35 cm (28 cm without mounting bracket)
- for hanging



Ref. no.	Colour	Width	Depth	Height	Capacity			€
3268	green	100 cm	35 cm	24 cm	42 L	1	120	

Ref. no.	Description	Material	Length	Width	Height		€
14526	Trough Holder for Long Feed Trough	galvanised metal	82 cm	13,5 cm	18 cm	1	

Feed trough

- shatter-proof plastic
- square



Top Seller

Made in the EU



Ref. no.	Description	Colour	Width	Depth	Height	Capacity			€
3258	without protective edge	green	42 cm	30 cm	32 cm	15 L	1	100	
32582	with protective edge (unmounted!)	green	42 cm	30 cm	32 cm	15 L	1	100	

Ref. no.	Description	Colour	Material		€
32581	Protective Edge	green	Plastic	1/25	

Feeding Trough with Metal Bars

- shatter-proof plastic
- the metal rods can be removed with a few simple steps
- with drain plug



Made in the EU



Ref. no.	Colour	Width	Depth	Height	Capacity			€
32465	green	33 cm	28 cm	33,5 cm	9 L	1	30	

Feed Troughs and Buckets

Trough for concentrated feed

- shatter-proof plastic • with drain plug



Top Seller

Made in the EU



Ref. no.	Colour	Width	Depth	Height	Capacity			€
32460	dark green	33 cm	28 cm	33,5 cm	9 L	1	150	

Feed trough

Plastic Feed Trough in a half-round shape without corners and edges. Very lightweight yet stable!

- half round design for mounting on straight walls
- with feed saver lip
- rounded transitions in the interior for better hygiene
- with cleaning plug for easy cleaning
- Material: polyethylene
- for wall mounting
- with drain plug



Made in the EU



Ref. no.	Colour	Length	Width	Height	Capacity			€
324825	green	55 cm	35 cm	17,7 cm	25 L	1	66	

Feeding Trough Corner Model

- complete with feed saver and bite protecting edge (not mounted)
- Material: Plastic
- for corner mounting



Made in the EU



Ref. no.	Colour	Width	Depth	Height	Capacity			€
32592	green	60 cm	45 cm	30 cm	31 L	1	50	

Ref. no.	Description	Colour	Material		€
32591	Protective Edge for Feeding Trough Corner Model	green	Plastic	1/25	



Tyre Trough

- high-quality sturdy feeding trough made from polyethylene
- ideal for feeding horses in large and/or open stables
- for proper feeding, as horses can feed in a natural stance
- suitable for tyres 175/14 or larger



Made in the EU



Ref. no.	Colour	Height	Ø	Interior diameter	Capacity			€
324826	green	19,5 cm	51 cm	35 cm	15 L	1	108	





Feed Troughs and Buckets

Feed trough HangOn 8L

for hanging

- made from sturdy, impact resistant plastic
- practical shape with spout and handle
- portable feed trough mountable on fixtures up to 40 mm in size
- with stable plastic brackets for mounting





Ref. no.	Colour	Width	Depth	Height	Capacity			€	
3211696	royal blue	27 cm	35 cm	25 cm	8 L	1	180		NEW
3211697	pink	27 cm	35 cm	25 cm	8 L	1	180		NEW
323481	green	27 cm	35 cm	25 cm	8 L	1	180		

Feed trough HangOn 13L

for hanging

- portable feed trough mountable on fixtures up to 40 mm in size
- made from sturdy, impact resistant plastic
- with stable plastic brackets for mounting



Ref. no.	Colour	Width	Depth	Height	Capacity			€	
3211694	royal blue	28 cm	37 cm	32 cm	13 L	1	136		NEW
3211695	pink	28 cm	37 cm	32 cm	13 L	1	136		NEW
323480	green	28 cm	37 cm	32 cm	13 L	1	136		

Feed trough HangOn 22L

- portable feed trough mountable on fixtures up to 40 mm in size
- made from sturdy, impact resistant plastic
- with stable plastic brackets for mounting



New product 



Ref. no.	Colour	Width	Depth	Height	Capacity		€
325819	green	38 cm	37 cm	33 cm	22 L	1	

Feed trough

for hanging

- transportable feed trough mountable on fixtures up to 50 mm in size
- almost indestructible rubber blend for the toughest situations
- ideal for stable or pasture
- tested quality: suitable for use in the food industry!
- rinse thoroughly with neutral soap-based cleaner before first use



Ref. no.	Colour	Capacity			€
323466	black	20 L	6	24	

Feeding Bowl

- universal bowl for food • impact- and temperature-resistant plastic • bowl and lid can be printed on request • food safe

14711:

- large capacity • with filling scale in litres and US gallons • with ring recess • easy to clean thanks to round recess



Available in customer-specific composition.

Ref. no.	Colour	Height	Ø	Capacity		€	
324817	grey	10 cm	21 cm	2 L	1		
324818	green	10 cm	21 cm	2 L	1		
324997	royal blue	10 cm	21 cm	2 L	1		NEW
324998	pink	10 cm	21 cm	2 L	1		NEW
324811	grey	12,5 cm	31,5 cm	6 L	1		
324812	green	12,5 cm	31,5 cm	6 L	1		
324813	olive green	12,5 cm	31,5 cm	6 L	1		
324995	royal blue	12,5 cm	31,5 cm	6 L	1		NEW
324996	pink	12,5 cm	31,5 cm	6 L	1		NEW
14711	olive green	18,5 cm	31,5 cm	8 L	1		



Ref. no.	Description	Colour		€
324810	Lid for Feeding Bowl 2 litres	white	1/5/50	
324820	Lid for Feeding Bowl 6 litres and 8 litres	white	1/5/50	

Made in the EU



All-Purpose Bucket

- very sturdy design
- Material: Plastic





Top Seller



Made in the EU





Ref. no.	Description	Colour	Ø	Capacity			€
29881		olive green	33 cm	12 L	1	350	
298800	food safe	blue transparent	33 cm	12 L	1	350	
298801	food safe	transparent pink	33 cm	12 L	1	350	

Ref. no.	Description	Colour	Material		€
29935	Lid for Stable and Construction Bucket	black	Plastic	1/30	

Feed Troughs and Buckets

All-Purpose Bucket Jumbo

- extra-sturdy design
- break-proof plastic
- extra smooth inner floor for complete draining
- with metal carry handle

Ref. no.	Colour	Capacity			€
29882	green	20 L	1	180	



Made in the EU



Cover for Buckets and Feeding Bowls

- the flexible cover for all containers up to Ø 40 cm
- water-repellent
- includes casing for label card 324483
- index cards not included

Ref. no.	Colour	MOQ	Pieces / unit		€
324482	black	1 pack	2 / pack	1/100	



Ref. no.	Description	Length	Width	MOQ	Pieces / unit		€
324483	Labelling Cards for Bucket Cover	12 cm	6 cm	1 pack	20 / pack	1/100	



Bucket Mount

- robust • for hanging buckets and food bowls • for wall mounting

321216:

- Bucket ring can be folded away when not in use • for wall mounting





Ref. no.	Description	Ø	Material			€
321216	foldable, for wall mounting	28 cm	galvanised metal	1/10	240	
1444	Standard	29,5 cm	galvanised metal	1	310	
1445	Dutch model	28 cm	galvanised metal	1	340	

Bucket Holder

- ideal for general purpose bucket 12 l



Ref. no.	Description	Material			€
32473	for hanging	galvanised metal	1	100	
32474	screw-on fastening	galvanised metal	1	100	



Feed Troughs and Buckets

Flexible Trough FlexBag

Multifunctional, robust plastic basket with two handles, characterised by its flexible material. It can be transported with either one hand, like a bag, or two hands. Ideally suited as a feed bucket, garden basket for leaves and waste, or as a carrying basket in the home.

- trough with two handles, made of robust but extremely flexible plastic
- flexibility of the material allows single-handed transport, like a bag
- universally usable as a food, transport, or cleaning materials bucket
- practical in field and stable, and also in house and garden



Ref. no.	Colour	Capacity			€	
3228293	royal blue	12 L	1/10	480		NEW
3228294	pink	12 L	1/10	480		NEW
3228264	black	12 L	1/10	480		
323530	green	12 L	1/10	480		
323531	purple	12 L	1/10	480		
323532	red	12 L	1/10	480		
3228265	black	15 L	1/10	960		
3210247	red	15 L	1/10	960		
3210248	blue	15 L	1/10	960		
3228295	royal blue	28 L	1/10	240		NEW
3228296	pink	28 L	1/10	240		NEW
3228266	black	28 L	1/10	240		
323533	blue	28 L	1/10	240		
323534	yellow	28 L	1/10	240		
323535	red	28 L	1/10	240		
3228267	black	42 L	1/10	240		
323536	blue	42 L	1/10	240		
323537	yellow	42 L	1/10	240		
323538	red	42 L	1/10	240		
3228268	black	60 L	1/10	400		
326197	red	60 L	1/10	400		
326198	blue	60 L	1/10	400		

Ref. no.	Description	Colour	Material		€
3228282	Lid for FlexBag 12 L	white	Plastic	1/40	





Top Seller



Rubber Trough

- universal rubber troughs in various sizes and designs
- flexible and also extremely durable
- tested quality: suitable for use in the food industry!
- rinse thoroughly with neutral soap-based cleaner before first use



Ref. no.	Colour	Height	Ø	Capacity			€
323462	black	14 cm	40 cm	11 L	1/8	144	
323463	black	18 cm	48 cm	20 L	1/6	48	



Food Box Stackable

- stackable box for storage of animal feed foodstuffs, etc.
- made from food-safe plastic
- perfect for stacking, because each box can be loaded up to 90 kg
- simple to remove content because of fixed positioning of cover
- box is easy to fill, because the cover opens completely and can be held in the open position through a special mechanism
- cover provides sufficient area for individual marking of food box
- cover can be locked by means of a padlock
- sophisticated anti-theft protection: the cover cannot be raised from the rear when closed
- with feed shovel on side
- universal cover, suitable for both sizes (40 and 60 litres)
- special cover design with water drainage channels



New product

NEW

available from: March 2025

Ref. no.	Description	Capacity		€
3210252	incl. lid	40 L	1	
3210253	incl. lid	60 L	1	

Ref. no.	Description	Material	suitable for		€
3210254	Cover for Stackable Food Box	Plastic	3210253, 3210252	1	

Mash Spoon

- practical help for mixing and stirring mash
- extremely robust and durable

New product

NEW

Ref. no.	Colour	Material		€
3230306	black	Plastic	1/100	
3230307	pink	Plastic	1/100	
3230308	purple	Plastic	1/100	



Water and feed trough

- equipped with 2 tear-resistant handles
- with a capacity of up to 45 litres, this trough is ideal for all manner of uses in the field or in the stable / sty
- made from stable, nearly unbreakable and impact-resistant plastic

Ref. no.	Colour	Capacity			€
323539	green	45 L	1/10	160	



Feed Troughs and Buckets

Petfood Container

The food container made from food-grade plastic provides a secure, airtight storage location for dry feed for dogs, horses, cats, etc.



- the cover can be closed tightly with the sturdy clip closure to protect against insect infestation and self-service
- airtight storage due to rubberised seal for long-lasting freshness
- Material: Plastic
- food safe

80830: for approx. 6 kg of dry feed

80831: for approx. 10 kg of dry feed

80832: for approx. 15 kg of dry feed, with rollers



Ref. no.	Colour	Length	Width	Height	Capacity			€
80830	white / brown	33 cm	22 cm	41 cm	15 L	1/6	198	
80831	white / brown	39 cm	24 cm	51 cm	25 L	1/6	144	
80832	white / brown	45 cm	27 cm	61 cm	40 L	1/6	90	

Feed bin



- for storing dry feed
- includes cover with stable locks
- protects against contamination, insect attacks and „self-service“
- Material: Plastic
- food safe

81329: for approx. 3 kg of dry feed

82268: for approx. 8 kg of dry feed

82269: for approx. 16 kg of dry feed



Ref. no.	Description	Colour	Height	Ø	Capacity			€
81329	Speedy	silver	31 cm	27 cm	8 L	1/8	288	
82268	Jerry	silver	46 cm	32 cm	23 L	1/6	108	
82269	Tom	silver	61 cm	40 cm	46 L	1/6	84	

Feed bin

- made from durable plastic for use as a feed bin or similar
- extremely light when empty and easy to carry thanks to the handles
- incl. cover to protect against contamination and insect infestation

Ref. no.	Colour	Height	Ø	Capacity		€
3210251	black	64 cm	45 cm	70 L	1	



Feed bin

- semi-transparent for immediate recognition of the level
- for storing dry feed
- includes cover to protect against contamination and insect infestation
- Material: polyethylene
- food safe

Ref. no.	Colour	Height	Ø	Capacity		€
3210249	white	60 cm	45 cm	70 L	1	
3210250	white	65 cm	52 cm	100 L	1	





Feed Troughs and Buckets

Feed and Water Pail FlatBack

- for pasture and stable as well as on the road while in transport • extremely sturdy bucket from nearly indestructible plastic • flattened back allows use as a feed bucket (wall mount 321215) • with measuring scale



Ref. no.	Colour	Capacity			€
323573	royal blue	20 L	1	180	
323574	pink	20 L	1	180	
323489	blue	20 L	1	180	
323490	green	20 L	1	180	
323493	black	20 L	1	180	

NEW
NEW





Made in the EU



Safety Wall Bracket FlatBack

- made of sturdy metal for extreme loads
- with safety lock for fixing the bucket
- also suitable for buckets having the same shape



Ref. no.	Colour	Material			€
321215	black	metal	1/45	540	

TV



Transport Manger with Hanging Bracket

- made from shatter-proof plastic
- with metal brackets for hanging
- also suitable for attaching in the horsebox

Ref. no.	Colour	Capacity			€
328165	royal blue	12 L	1	100	
328166	pink	12 L	1	100	
32851	red	12 L	1	100	
32852	dark green	12 L	1	100	
32853	blue	12 L	1	100	
32855	black	12 L	1	100	
32859	light green	12 L	1	100	

NEW
NEW





Made in the EU



Tournament feed manger with hanging bracket and carrying handle

- stable plastic
- with metal brackets for hanging in transporters or horse boxes
- additional metal handle



Ref. no.	Colour	Capacity			€
328167	royal blue	12 L	1	100	
328168	pink	12 L	1	100	
32871	red	12 L	1	100	
32872	dark green	12 L	1	100	
32873	blue	12 L	1	100	
32875	black	12 L	1	100	
32876	light green	12 L	1	100	

NEW
NEW



Top Seller

Made in the EU



Water container for wheelbarrow H2GoBag

for stable and pasture

- to store and transport water (for places where a hose will not reach)
- simple, practical and flexible to use. For example, in stables, pastures or gardens
- incl. antislip mat for the wheelbarrows



Ref. no.	Colour	Length	Width	Capacity			€
29382	blue	100 cm	70 cm	80 L	1/12	600	

Stabilising Wheels for Wheelbarrow

- in pairs
- wheel set for retrofitting on any standard garden and construction wheelbarrows, also suitable for older wheelbarrows or those already in use
- with the additional stabilising wheels on the back stand bars, the wheelbarrow can be pushed without much effort - especially under a heavy load. This relieves the back and the arms, making everyday work so much easier
- for gardening, landscaping and construction
- very easy to fit using the mounting clips provided - no drilling required
- patented



The kit and the solid rubber tyres are not licensed for road use!

Now with solid rubber tires!

Ref. no.	Colour	Diameter		€
29396	black	25 cm	1	

Bag BarrowBag

- versatile carrying bag for stable, yard and garden
- ideal for increasing the filling volume of the wheelbarrow
- suitable for e.g. hay, straw, leaves or grass cuttings
- robust and tear-resistant
- with handle



Ref. no.	Colour	Length	Width	Height	Capacity		€
29388	green	90 cm	60 cm	50 cm	270 L	1/12	

Bag GoBag

- versatile carrying bag for stable, yard and garden
- suitable for garden waste, animal feed and much more
- robust and tear-resistant
- self-supporting
- handle on the underside for emptying



Ref. no.	Colour	Length	Width	Height	Capacity		€
29387	green	45 cm	45 cm	60 cm	120 L	1/12	



Hay Racks and Hay Nets

Hay net with ring

- close-mesh hay net offers various advantages: Prolongation of feeding times, avoidance of food jealousy, etc.
- easy filling of the hay net thanks to integrated plastic ring
- without metal rings
- Material: Polypropylene





New product 

Ref. no.	Colour	Height	Ø	Mesh size	loose hay capacity		€
3230534	green	90 cm	40 cm	4,5 x 4,5 cm	approx. 5 kg	1/18	
3230535	green	120 cm	40 cm	4,5 x 4,5 cm	approx. 7 kg	1/15	

Hay Net, Tunnel Shape

- practical hay tunnel that can be filled from both sides
- sturdy belts with spring snap hooks to the sides for easy mounting
- Metal inserts at the end and in the middle for easy filling
- easy opening via zip for filling and refilling
- tear-resistant and durable





Ref. no.	Colour	Length	Width	Mesh size	loose hay capacity			€
3282836	black	150 cm	50 cm	5 x 5 cm	approx. 11 kg	1/5	20	

Hay Net with Filling Aid

- reinforced hook-and-loop fastener to the opening prevents accidental opening of the hay bag
- practical hanging hook, can also be used as a filling aid
- extremely tear-resistance and durable





Ref. no.	Colour	Length	Width	Mesh size	loose hay capacity			€
3211645	white	83 cm	83 cm	3 x 3 cm	approx. 5,5 kg	1/20	200	
3222179	white	90 cm	110 cm	3 x 3 cm	approx. 8 kg	1/16	160	
3222180	white	100 cm	150 cm	3 x 3 cm	approx. 12 kg	1/12	120	

Hay Racks and Hay Nets

Hay Net Set of 5

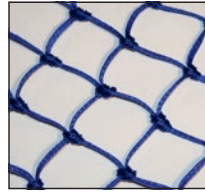
- small-mesh hay net offers many benefits: longer feeding times, prevention of food jealousy etc.
- with rings



Ref. no.	Colour	Mesh size			€
321284	black	5 x 5 cm	1/30	240	
321296	red	5 x 5 cm	1/30	240	
321297	green	5 x 5 cm	1/30	240	
321298	blue	5 x 5 cm	1/30	240	





Top Seller

Hay Net Set of 10

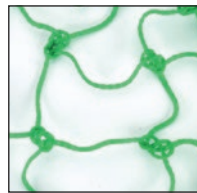
- with rings





Ref. no.	Colour	Mesh size			€
32695	red	10 x 10 cm	1/60	720	
32696	green	10 x 10 cm	1/60	720	
32697	blue	10 x 10 cm	1/60	720	
32698	black	10 x 10 cm	1/60	720	



Hay net Nova

- small-mesh hay net offers many benefits: longer feeding times, prevention of food jealousy etc.
- handwoven design
- without metal rings

Ref. no.	Colour	Mesh size			€
3224659	black	50 x 50 mm	1/30	240	
3227321	blue	50 x 50 mm	1/30	240	
3224661	black	30 x 30 mm	1/30	240	
3227323	blue	30 x 30 mm	1/30	240	



Hay Net Retaining Hook

Easy, one-handed mounting of hay nets and much more.

- hook-in and remove products on the rope without tools
- can be mounted directly onto a wall or pipes with a diameter of 10 to 40 mm
- with integrated thread and screws for mounting on pipes
- no risk of injury to horses thanks to smooth surface
- Material: Aluminium

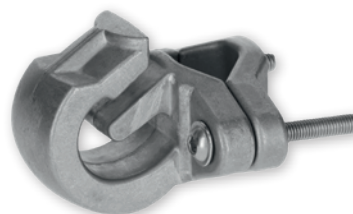

Ref. no.		€
3224775	1/50	



Hay Net for Round Bales

- Feeding net for hay and silage bales for feed-saving roughage supply to horses
- Hay is no longer dispersed
- secure attachment by elastic cord
- tear-resistant and durable
- soft material, protects the horse's mouth
- universal use
- Rope thickness: 6 mm
- not recommended for horses with horseshoes due to risk of fouling
- Material: Polypropylene





Ref. no.	Colour	Height	Ø	Mesh size			€
3227439	green	140 cm	140 cm	4,5 x 4,5 cm	1/4	48	
321603	green	150 cm	150 cm	4,5 x 4,5 cm	1/4	32	
3227440	green	160 cm	160 cm	4,5 x 4,5 cm	1/4	40	
321604	green	180 cm	180 cm	4,5 x 4,5 cm	1/3	30	

Hay Net for Round Bales

Hangable feeding net for hay and silage bales for feed-saving roughage supply to horses.

- Hay is no longer dispersed
- Fastening with integrated cable
- tear-resistant and durable
- soft material, protects the horse's mouth
- universal use
- Rope thickness: 6 mm
- Material: Polypropylene



Ref. no.	Colour	Height	Ø	Mesh size			€
321605	green	160 cm	125 cm	4,5 x 4,5 cm	1/5	40	
321606	green	180 cm	150 cm	4,5 x 4,5 cm	1/3	36	

Hay Bag

- ideal for tournaments, transport or in the stable
- with 2 hanger rings
- Material: Polyamide

Ref. no.	Colour	Length	Width		€
3280	black	65 cm	50 cm	1/10/50	
3222320	black	90 cm	63 cm	1/50	





Hay net FlexiStrong

The practical and fast-fill hay net bag made from extra strong material

- easy to attach with quick release buckles
- thick 6 mm cord for long life
- for the box, paddock or pasture
- easy to fill
- Material: Polypropylene





Ref. no.	Colour	Length	Width	Mesh size	loose hay capacity			€
3223400	green	90 cm	90 cm	4,5 x 4,5 cm	approx. 7 kg	1/20	200	
3223401	green	150 cm	100 cm	4,5 x 4,5 cm	approx. 10 kg	1/10	100	
3223402	green	200 cm	120 cm	4,5 x 4,5 cm	approx. 20 kg	1/8	80	

Hay net

- promotes proper feeding
- extremely tear-resistance and durable
- small-mesh hay net offers many benefits: longer feeding times, prevention of food jealousy etc.
- up to 30 % less feed wastage



Ref. no.	Description	Colour	Length	Width	Mesh size	loose hay capacity			€
321999	for ponies and trailers	white	90 cm	60 cm	3 x 3 cm	approx. 4 kg	1/25	250	
321998	for 12 hour feed	white	120 cm	90 cm	3 x 3 cm	approx. 8,5 kg	1/25	150	
322000	for 24 hour feed	white	160 cm	100 cm	3 x 3 cm	approx. 16 kg	1/15	90	

Filling Aid for Hay Nets

- practical aid for filling hay nets
- with legs for easy handling and flexible placement
- easy and fast to assemble with just a few hand movements
- sturdy design with opening for easy removal of the filled net



Ref. no.	Colour	Height	Ø			€
32694	black	90 cm	51 cm	1	42	

Hay Racks and Hay Nets

HayBag

The HayBag brings together many benefits in one product.

- up to 15 % less feed wastage
- easy to fill and clean
- ideal for species-appropriate feeding of hay
- universally usable and easy to mount in stables or pasture

326102: 12 side holes with 20 cm spacing

326103: 15 side holes with 20 cm spacing

3224774: 12 side holes with 20 cm spacing

3230309: 20 side holes with 20 cm spacing



Ref. no.	Description	Colour	Height	Material	Ø	Capacity		€
326102	Small	black	70 cm	PVC	37 cm	85 L	1/10	
326103	Big	black	90 cm	PVC	48 cm	195 L	1/6	
3224774	Small	grey	70 cm	Cotton	37 cm	85 L	1/12	
3230309	Big	grey	90 cm	Cotton	55 cm	210 L	1/12	NEW

Ref. no.	Description	Material	suitable for		€
3224775	Hay Net Retaining Hook	Aluminium		1/50	
323506	Wall Mount	galvanised metal	323500, 326102, 326103, 3224774, 323509, 299135	1/10	
326104	Floor bracket	galvanised metal	323520, 326102, 326103, 3224774, 299135, 3230309	1	

Hay bag

The hay bag promotes the slow and digestible intake of roughage and prevents the animals from spreading the hay on the ground. Made of polypropylene material, the bag is tearproof and durable, perfect for use in the box or on the go.

- hay bag for the economical feeding of horses with roughage
- for a calm, digestible eating behaviour
- prevents horses from spreading the hay on the ground
- tear-resistant and durable
- secure fastening through loops and snap hooks
- easy to fill and can be attached in various ways
- for stable, transport or tournaments



Ref. no.	Length	Width	Height	Mesh size			€
3228273	68 cm	55 cm	18 cm	5 x 5 cm	1/12	96	

Wall Rack SlowFeed Plus

- stable wall rack for horses, for breed-appropriate feeding
 - grille spacing of 5 cm ensures slow eating and increases the well-being of the animals
 - with flap cover for simple rapid filling with up to 14 kg hay (depending on structure and compression)
 - inclined base plate ensures the remaining hay slides down
 - footboard protection due to the bars reaching down to the floor
 - delivered as a kit, and very easy to assemble
 - for wall-mounting (fastenings included in scope of delivery)
 - Material: galvanised metal
- 3226: retrofittable attachment, can accommodate up to approx. 25 kg of hay
 - Front door makes opening and closing easy while preventing the animals from opening it accidentally
 - Front door can be hung on either side (right-hand hinge or left-hand hinge)



Ref. no.	Width	Height	Depth	Weight	Rod distance		€
3225	81 cm	114 cm	41 cm	32 kg	5 cm	1	



Ref. no.	Description	Material	Width	Depth	Height		€
3226	attachment for wall rack SlowFeed Plus	galvanised metal	81 cm	41 cm	81 cm	1	

NEW

Hay Rack

- heavy-duty design
- Material: galvanised metal
- for wall mounting



Ref. no.	Description	Length	Width	Height	Rod distance	Bar thickness			€
3230	small model	56 cm	29,5 cm	23 cm	80 mm	10 mm	1	78	
3231	large model	75,3 cm	47,5 cm	46,5 cm	85 mm	10 mm	1	44	





Hay Racks and Hay Nets

Double Hay Rack

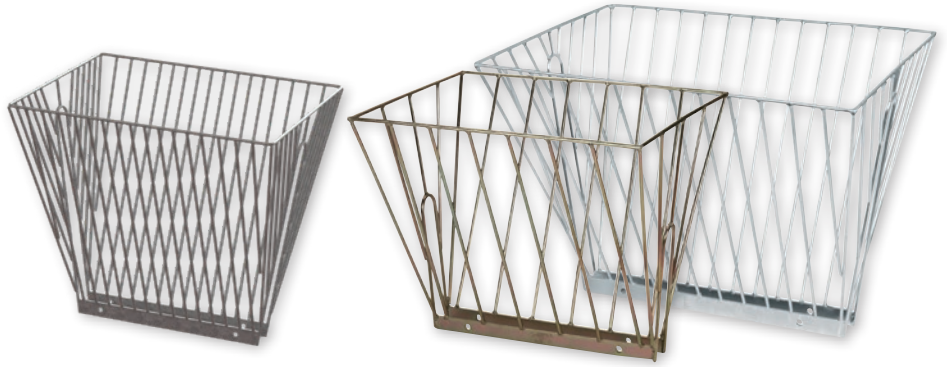
- for mounting on boxes or sides up to max. 43 mm width
- Material: galvanised metal





Ref. no.	Length	Width	Height	Rod distance	Bar thickness			€
3232	53 cm	44 cm	48 cm	22 mm	6 mm	1	50	
32704	62,5 cm	51 cm	48 cm	40 mm	6 mm	1	50	
32702	61,5 cm	50 cm	48 cm	80 mm	8 mm	1	30	

Feed Storage Rack

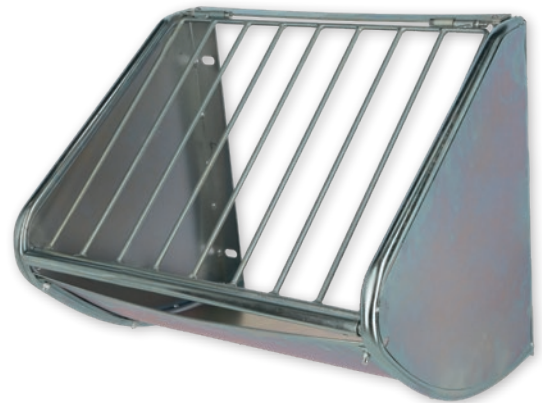
- high-quality sturdy feed storage rack made from galvanised metal for wall mounting
- the design allows the horse to eat appropriately and slowly
- the grid is pressed against the food by the rotary hinge when the horse eats, so it receives small portions and is engaged for a long period
- Raw food can be easily refilled by lifting the grid from the front or from behind as required and through an opening in the box partition
- supplied as a kit
- incl. assembly instructions, easy assembly





Ref. no.	Length	Width	Height	Weight	Rod distance	Capacity			€
32706	60 cm	47 cm	53 cm	14 kg	6 cm	90 L	1	20	

Ref. no.	Description	Material		€
3210599	Replacement Feed Grille	galvanised metal	1/10	

Hay Rack Half-round

- Bar spacing: top 115 mm, bottom 30 mm
- Material: galvanised metal
- for wall mounting





Ref. no.	Length	Width	Height	Bar thickness			€
32701	75 cm	41,5 cm	64,5 cm	10 mm	1	25	

Corner hay rack

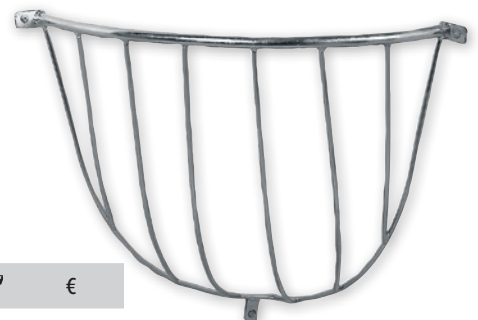
- Material: galvanised metal
- for wall mounting



Ref. no.	Length	Width	Height	Rod distance	Bar thickness			€
3271	70 cm	52 cm	61 cm	105 mm	10 mm	1/5	50	

Fodder rack HayBox

The hay box for the humanely feeding horses. Food intake is slow but steady and can thus contribute to the well-being of the horse.



- fewer digestion problems through slow eating
- very fast to fill and easy to clean
- sturdy, galvanised metal grid with 6 cm bar spacing
- Horses eat in their natural position - for stable, paddock etc.
- for approx. 8 - 10 kg hay (depending on the structure and pressing)
- if required, a floor or wall mount is available as an accessory for better mounting
- the hay dust falls to the floor through the perforated base plate – also ideal for wet or damp hay (excess water can drain)
- supplied with metal grille
- Material: HDPE
- incl. assembly instructions, easy assembly
- supplied as a kit



Made in the EU



ideal for dust allergy sufferers

Ref. no.	Width	Height	Depth			€
3210373	80,8 cm	56 cm	61 cm	1	22	

Ref. no.	Description	Material		€
3210375	Floor Mounting Set	galvanised metal	1/12	
3210376	Wall Mounting Kit	galvanised metal	1	
3210377	Base Plate	polyethylene	1/25	
3210378	Closure Set for Net Frame Opening	galvanised metal	1/250	
3210379	Hay grid	galvanised metal	1/10	

Hay Cutter TF 2000 M

- suitable for vertical as well as horizontal cutting of hay bales, allows for dust free working
- its perfect cutting, handling and ease of use without maintenance requirements reduce labour costs
- the TF 2000 M hay cutter is perfect for cutting hay bales, pressed fodder and silage (e.g. hay, corn, millet, beet leaves or grass silage in a clamp silo)
- with closed blade
- cuts round hay bales without raker
- Sound pressure level: 103.5 LWA
- Vibration level ISO 5349: 5.9 m/sec²

Technical data	29190
Voltage	230 V AC
Mains frequency	50 Hz
Output	1.400 W
Plug type	Safety Plug E + F
Weight	13,4 kg
Cutting width	25 cm
Cutting height	60 cm
Sound pressure level	89,9 LpAm

Ref. no.	Colour	Plug type		€
29190	black / blue	Safety Plug E + F	1	



Mistboy® Mini

Finally, a Mistboy that also gives kids a great deal of pleasure when collecting horse and dog droppings. The optimal size of the shovel and the height of the handle were designed so that the filling volume and carrying comfort are perfect for young animal lovers.

- extremely lightweight at only 1200 g
- total height of 60 cm is perfect for children
- new type of rake made from ABS - break-proof and hard-wearing
- optional accessory 328034 for secure and space-saving storage



Made in the EU



Ref. no.	Colour	Height	Weight approx.			€
328998	royal blue	60 cm	1.200 g	1	100	
328999	pink	60 cm	1.200 g	1	100	
328035	light green	60 cm	1.200 g	1	100	

NEW
NEW



Ref. no.	Description	Colour	Material	Length		€
328038	Crook for Mistboy®	anthracite	Plastic	60 cm	1	

Holder for Wall Mounting Mistboy

- practical wall bracket for space-saving storage of our Mistboy
- easy assembly
- break-proof plastic

Made in the EU



Ref. no.			€
328034	1/100	1.200	



Mistboy®

- the Mistboy features an even more stable shovel and a multi-functional crook
- the new shovel shape holds more volume and is easier to stack
- Crook with a closed plate on the reverse, allowing easier scraping and faster working
- ideal for cleaning out boxes, for horse transporters or for quickly clearing out the paddock

328068



Ref. no.	Colour	Length			€
328146	royal blue	75 cm	1	70	
328147	pink	75 cm	1	70	
32808	light green	75 cm	1	70	
3281	black	75 cm	1	70	
328148	royal blue	90 cm	1	60	
328149	pink	90 cm	1	60	
324110	light green	90 cm	1	60	
324107	black	90 cm	1	60	

NEW
NEW

NEW
NEW



Top Seller

Made in the EU



Ref. no.	Description	Colour	Material	Length		€
328068	Crook for Mistboy®	anthracite	Plastic	75 cm	1	
32811	Shovel for Mistboy®	black	Plastic	75 cm	1	
32812	Crook for Mistboy®		metal	75 cm	1/10	
324111	Shovel for Mistboy®	black	Plastic	90 cm	1	
324112	Crook for Mistboy®		metal	90 cm	1/10	

Muck Scraper

- multi-functional tool can also be used with the Mistboy and as a general rake
- Adjustable tine width 20 - 45 mm
- with telescopic handle, max length 140 cm



Ref. no.	Handle	Tines			€
3210380	140 cm	15	1/6/12	240	

Stable, Spreading and Manure Forks

- sturdy straw and dung fork made from high-quality plastic
- a total of 13 flexible tines with edge reinforcement
- matching handle: 2959



Made in the EU



made from shatterproof ABS plastic

Ref. no.	Handle	Colour	Length	Width	Tines			€
32889	with ash handle	black	45 cm	40 cm	13	1	50	
32882	without handle	black	45 cm	40 cm	13	1/8	168	

Ref. no.	Description	Material	Length		€
2959	Bedding and Manure Fork Handle	ash	135 cm	1/25	



Litter fork Premium

THE new muck fork made from innovative indestructible plastic!

Made from a special mixture of various different plastics to ensure optimum flexibility both at high and low temperatures.

- conceived for the hardest of applications when mucking out in the horsebox or in the trailer
- special tine shape ensures easy muck pick-up
- especially light, even with the shaft fitted, by the use of an aluminium shaft
- made in Europe - individually tested to the most stringent of quality requirements with regard to impact resistance, fracture load and temperature resistance (-20 to +50 °C)
- increased UV stability
- matching handle: 323477



Top Quality

Made in the EU



Ref. no.	Handle	Colour	Tines			€
323475	without handle	black	17	1/12	324	
323476	without handle	green	17	1/12	324	
323473	with aluminium handle and D-grip	black	17	1	120	
323478	with aluminium handle and D-grip	green	17	1	120	

Ref. no.	Description	Material	Length	Length adjustable		€
3230536	Aluminium Telescopic Handle	Aluminium		85 - 150 cm	1/20	
323477	Aluminium shaft with D-grip	Aluminium	125 cm		1/20	
32809	Aluminium Telescopic Handle	Aluminium		85 - 150 cm	1/48	

323473



NEW



Litter fork EcoFork Mini

The EcoFork Children's Litter Fork, a robust and lightweight tool in vibrant colours with lightweight aluminium handle, enables little farm helpers aged 5 and over to take part in farm work in a playful way.

- robust and durable, made from virtually unbreakable plastic
- lightweight aluminium handle for small hands
- suitable for children aged 5 and over
- child-friendly size, ideal for playful help on the farm
- safe and functional, specially developed for the needs and abilities of children

New product 

available from: March 2025

Ref. no.	Handle	Colour	Length	Width	Tines		€
3230573	without handle	pink	27,2 cm	31 cm	14	1	
3230574	with handle	pink	113 cm	31 cm	14	1	
3230576	without handle	royal blue	27,2 cm	31 cm	14	1	
3230577	with handle	royal blue	113 cm	31 cm	14	1	



Ref. no.	Description	Material	Length	Length adjustable		€
3230536	Aluminium Telescopic Handle	Aluminium		85 - 150 cm	1/20	
3230575	Aluminium shaft with D-grip	Aluminium	93 cm		1/20	



NEW

Litter fork EcoFork

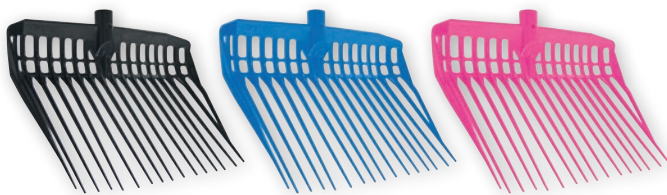
- Litter Fork with a completely new shape and design
- made from nearly unbreakable plastic
- with 16 highly elastic and rear-reinforced tines
- also available with a light and sturdy Metal Curry Comb incl. a non-slip D handle
- matching handle: 32809, 323477, 3299, 3230536



Top Seller

Ref. no.	Handle	Colour	Length	Width	Tines			€
326052	without handle	black	38 cm	30 cm	16	1/40	560	
326053	without handle	royal blue	38 cm	30 cm	16	1/40	560	
326054	without handle	pink	38 cm	30 cm	16	1/40	560	
326055	with metal handle with D-grip	black	38 cm	30 cm	16	1		

Ref. no.	Description	Material	Length	Length adjustable		€
3230536	Aluminium Telescopic Handle	Aluminium		85 - 150 cm	1/20	
323477	Aluminium shaft with D-grip	Aluminium	125 cm		1/20	
32809	Aluminium Telescopic Handle	Aluminium		85 - 150 cm	1/48	
3299	Metal handle with D-grip	steel, powder-coated	125 cm		1/20	

NEW

Litter fork Maxi

- deep litter fork in a compact design
- mucking out goes faster than with flat forks due to the large filling volume
- made from nearly unbreakable plastic
- with 17 highly elastic and rear-reinforced tines
- matching handle: 3299, 32809, 323477, 3230536



326056



Top Seller

Ref. no.	Handle	Colour	Material	Length	Width	Tines			€
326056	without handle	black	Plastic	38 cm	30 cm	17	1/16	320	

Ref. no.	Description	Material	Length	Length adjustable		€
3230536	Aluminium Telescopic Handle	Aluminium		85 - 150 cm	1/20	
323477	Aluminium shaft with D-grip	Aluminium	125 cm		1/20	
32809	Aluminium Telescopic Handle	Aluminium		85 - 150 cm	1/48	
3299	Metal handle with D-grip	steel, powder-coated	125 cm		1/20	

NEW

Litter fork Aubiose

- proven branded product
- laterally raised prongs
- heavy-duty design
- matching handle: 3298



Ref. no.	Handle	Colour	Material	Length	Width			€
321	with aluminium handle and D-grip	black	Plastic	40 cm	30 cm	1/5		
3290	without handle	black	Plastic	40 cm	30 cm	1/30	450	

Ref. no.	Description		€
3298	Handle Aubiose	1/20	

Litter fork

- Tine length: approx. 31 cm • with spring sleeve



Ref. no.	Handle	Colour	Material	Tines			€
3297	without handle	black	metal	20	1/5	250	

Leaf rake

Combined tool, one side for leaf raking and, by turning over through 180°, can also be used as a fork to move the collected items to a container without having to bend over.

- with handle halter
- matching handle: 29603



Ref. no.	Handle	Colour	Width	Tines	Ø handle holder			€
29365	without handle	yellow	45 cm	20	27 mm	1/25	300	
29366	without handle	yellow	60 cm	26	27 mm	1/25	300	
293660	with handle	yellow	60 cm	26	27 mm	1	50	

Ref. no.	Description	Material	Length		€
29603	Device and Broom Handle with cone	Aspen Wood	140 cm	1/25	

Aluminium Telescopic Handle

• with screw and self-locking nut • suitable for manure fork 3287, 323475, 323476, 3290 and Maxi and EcoFork



Ref. no.	Material	Length adjustable			€
32809	Aluminium	85 - 150 cm	1/48	576	
3230536	Aluminium	85 - 150 cm	1/20		

NEW

Device and Broom Handle



Ref. no.	Description	Material	Length	Diameter			€
29603	with cone	Aspen Wood	140 cm	27 mm	1/25	1.000	
2961	with cone	Aspen Wood	150 cm	27 mm	1/25	1.000	
29604	with cone	Aspen Wood	160 cm	27 mm	1/25	1.000	
29611	with cone	Aspen Wood	180 cm	27 mm	1/25	1.000	
2962	without cone	Aspen Wood	130 cm	24 mm	1/25	1.000	
29602	without cone	Aspen Wood	140 cm	24 mm	1/25	1.000	

Aluminium Shovel Profi

- abutment edge, galvanized
- extra-thick material approx. 2.5 mm
- with handle halter
- matching handle: 29581, 29589, 29674, 29585

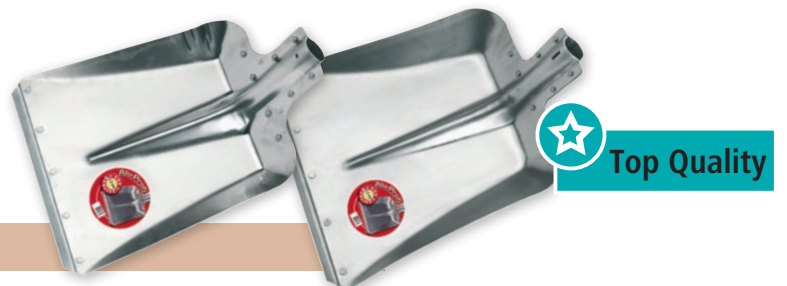

2.5 mm material thickness

Ref. no.	Handle	Size	Material	Width	Ø handle holder			€
29675	without handle	9	Aluminium	36 cm	38 mm	1/10	200	
2977	without handle	7	Aluminium	32 cm	38 mm	1/10	280	

Snow and grain shovel

- various grip options
- working positions that are gentle on the body
- light and stable
- Edge material: aluminium
- with handle halter
- matching handle: 29589, 29581

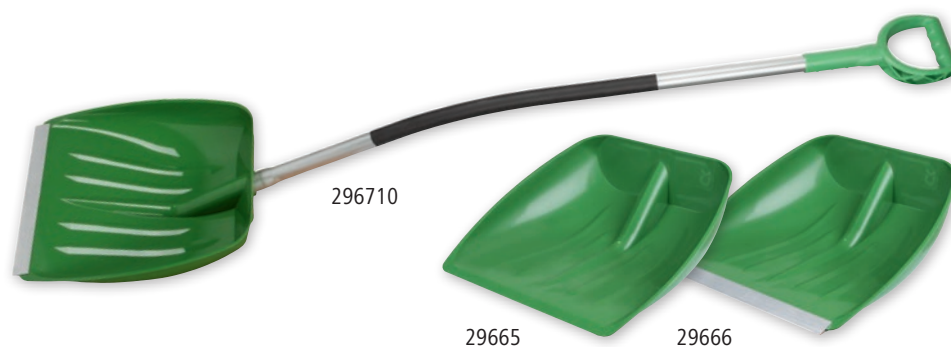

Ref. no.	Description	Handle	Colour	Material	Length	Width	Height	Ø handle holder			€
29665	without protective edge	without handle	green	Plastic	41 cm	39 cm	11 cm	39 mm	1/5	150	
29666	with protective edge	without handle	green	Plastic	44 cm	39 cm	17 cm	39 mm	1/5	150	
296710	with protective edge	with aluminium handle and D-grip	green	Plastic	42 cm	40 cm	10 cm	39 mm	1/5	50	

Aluminium Shovel

- with protective edge
- Material thickness: 2 mm
- with handle halter
- matching handle: 29583



Ref. no.	Handle	Size	Material	Width			€
29691	with beech handle 135 cm	9	Aluminium	36 cm	1/5	70	

Snow and grain shovel

- various grip options
- working positions that are gentle on the body
- Material thickness: 2 mm
- with handle halter
- matching handle: 29589, 29674, 29585, 29581

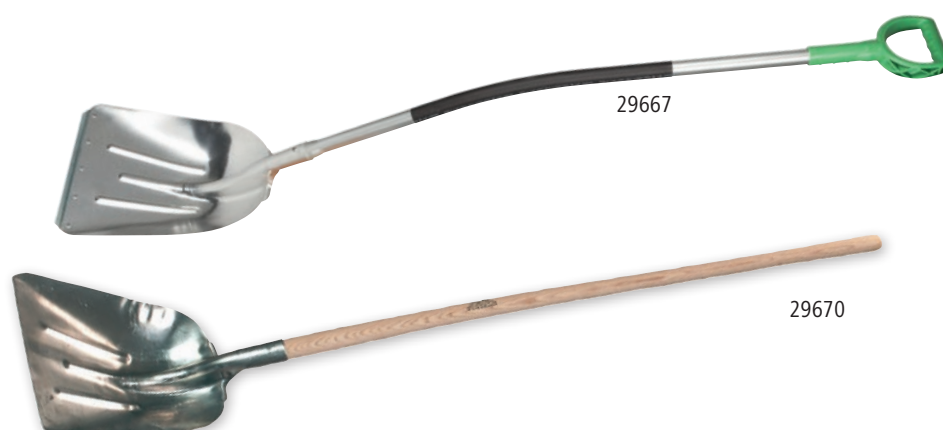

Ref. no.	Description	Handle	Material	Length	Width	Ø handle holder			€
29670	without protective edge	with beech handle	Aluminium	41 cm	33 cm	39 mm	1/5		
29671	with protective edge	without handle	Aluminium	41 cm	33 cm	39 mm	1/10	160	
29667	with protective edge	with aluminium handle and D-grip	Aluminium	41 cm	33 cm	39 mm	1/5	25	

Ref. no.	Description	Material		€
29673	Edge with Rivets	metal	1/10/150	



Feed Scoop

- Material: Plastic
- with embossed measuring scale



New product



NEW

Ref. no.	Colour	Capacity			€
29726	transparent	2 L	1/48	576	
29800	royal blue	2 L	1/48	576	
29801	pink	2 L	1/48	576	

Feed Scoop

- break-proof plastic





Ref. no.	Colour	Capacity			€
29624	light green	500 g	1/80	960	NEW
29625	light green	2000 g	1/40	480	NEW
29694	light green	2000 g	1/60	720	

Weigh Scoop



- for weighing concentrated feed



Ref. no.	Description	Material	Capacity			€
29758	angular	Aluminium	900 g	1/50	800	
29796	round	Aluminium	900 g	1/80	800	
29760	angular	Aluminium	1600 g	1/75	600	
29797	round	Aluminium	1600 g	1/50	400	
29761	angular	Aluminium	2500 g	1/50	400	
29798	round	Aluminium	2500 g	1/40	320	

Weigh Scoop Inverted Handle

- Handy
- versatile application

Ref. no.	Material	Capacity			€
29762	Aluminium	1250 g	1/50	300	
29763	Aluminium	2000 g	1/40	240	



29763

Feed Scoop

- rectangular shape • robust construction • with ergonomic handle
- very versatile

Available in customer-specific composition.

Ref. no.	Colour	Material	Capacity			€
29689	green	Plastic	1000 g	1/64	768	



Feed shovel digital

- for weighing feed for horses, dogs, cats, chickens, etc. • digital, easy-to-read on-screen display • different measurement units (grams, millilitres, cups and oz) • Tare function for easy add-on weighing • Shovel part is removable and dishwasher-safe for easy cleaning • made from feed-safe plastic • immediately ready for use thanks to supplied battery • operated with: 1 x 3 V - CR2032 • Battery included



Technical data

Battery Operation 1 x 3 V - CR2032

Ref. no.	Length	Weighing range		€
3228274	23 cm	0 - 800 g	1/60	

Ref. no.	Description		€
29918	Button Battery 3 Volt	1/20	

Street Brush extra-coarse

- extra strong, red plastic bristles made from elastane • quality design • with reinforced wooden back • with handle hole • matching handle: 2961



Ref. no.	Handle	Colour	Width	Ø handle holder		€
29519	without handle	red	35 cm	25 mm	1/10	
29520	without handle	red	42 cm	25 mm	1/10	



Top Quality

Made in Germany



Street Broom Kompakt

- wooden back • with elastane bristles • with handle hole • matching handle: 2961

Ref. no.	Handle	Colour	Width	Ø handle holder		€
29521	without handle	red	35 cm	25 mm	1/10	
29475	without handle	red	42 cm	25 mm	1/10	



Made in Germany



Large broom

- wooden back • suitable handle for handle holder Ø 24 mm: 2962
- suitable handle for handle holder Ø 27 mm: 2961 • with elastane bristles • with bolted handle holder



Our most sold product!

Ref. no.	Handle	Colour	Width	Ø handle holder		€
2943	without handle	red	40 cm	24 mm	1	
2944	without handle	red	50 cm	24 mm	1	
2945	without handle	red	60 cm	27 mm	1	
2946	without handle	red	80 cm	27 mm	1	
29461	without handle	red	100 cm	27 mm	1	





Top Quality

Made in Germany



Rice straw broom

- premium quality • with wooden handle

Ref. no.	Description	Handle			€
29489	4-joint	135 cm	1/10	220	
29488	5-joint	135 cm	1/10	220	



Made in Germany



Universal Broom

- Plastic Back • matching handle: 29437

The ideal universal broom for stable, yard and house!



Ref. no.	Handle	Colour	Width			€
29435	with metal handle 150 cm	green	40 cm	1	100	

Ref. no.	Description	Colour	Material	Length		€
29437	Handle single	green	metal	150 cm	1/10	



Besom made from bamboo

- Brush head made from sustainable bamboo • Broom with integrated stem aid • ideal for stall and farmyard, because no straw becomes entangled • reduced effort when sweeping • light and durable • Bamboo brush head is environmentally friendly, made from compostable, renewable raw materials • matching handle: Bamboo 29498 or Aspen 2962, 29602

Ref. no.	Length			€
29497	110 cm	1	240	

Ref. no.	Description	Length		€
29498	Bamboo stem for brush-head broom	100 cm	1/25	



29497



29498

Strip Curtain

Protection against cold and draughts exclusively for use in agriculture, industry or outdoors in other areas of application.

- dust, spray and sound protection for machinery and equipment • avoid draughts • Use in agricultural and industrial halls and stables as well as paddocks • high light permeability • rounded long edges • high wear resistance • problem-free and simple fastening thanks to hook strips (available in four length) and hanging panels in 20 cm and 30 cm • metal parts made from high-quality AISI 304 stainless steel • Material: PVC, UV-stabilised
- Operating ambient temperature: -20 - 50 °C

291177: Special Polar version - particularly suitable for areas with long cold periods below -20 °C

Our recommendation for optimised fastening:

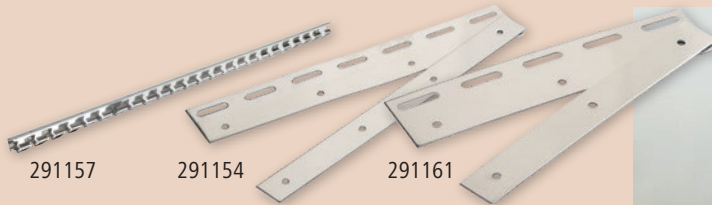

Hook strip / passage width	Strip width 30 cm	Strip width 20 cm
1 m	5 panels	8 panels
1,25 m	6 panels	10 panels
1,5 m	7 panels	12 panels
2 m	10 panels	16 panels

Ref. no.	Colour	Roll length	Strip width	Material thickness			€
291156	transparent	25 m	20 cm	2 mm	1	40	
291155	transparent	50 m	20 cm	2 mm	1	24	
291177	transparent	25 m	20 cm	3 mm	1	30	NEW
291150	transparent	25 m	30 cm	3 mm	1	18	
291151	transparent	50 m	30 cm	3 mm	1	6	

Ref. no.	Description	Material	Length	MOQ	Pieces / unit		€
291157	Hook Strip for PVC Strip Curtain	Stainless Steel AISI 304	100 cm			1/10	
291158	Hook Strip for PVC Strip Curtain	Stainless Steel AISI 304	125 cm			1/10	
291159	Hook Strip for PVC Strip Curtain	Stainless Steel AISI 304	150 cm			1/10	
291160	Hook Strip for PVC Strip Curtain	Stainless Steel AISI 304	200 cm			1/10	
291161	Hanging Panel for PVC Strip Curtain	Stainless Steel AISI 304	20 cm			1/60	
291154	Hanging Panel for PVC Strip Curtain	Stainless Steel AISI 304	28,5 cm			1/40	
291154-1	Screw and Nut Set for Hanging Panels			1 pouch	8 / pouch	1	

Strip Curtain Set

Protection against cold and draughts exclusively for use in agriculture, industry or outdoors in other areas of application.

- dust, spray and sound protection for machinery and equipment • avoid draughts • Use in agricultural and industrial halls and stables as well as paddocks • high light permeability • rounded long edges • high wear resistance • metal parts made from high-quality AISI 304 stainless steel

Set consisting of: 5 x PVC strips 30 x 225 cm, 3 mm thick, 5 x hanging panels 30 cm, 2 x hook strips (total length 130 cm)



Hanging panels pre-mounted on PVC strips

Ref. no.			€
291162	1	16	

Ref. no.	Description	Length	Width	MOQ	Pieces / unit		€
291154-1	Screw and Nut Set for Hanging Panels			1 pouch	8 / pouch	1	
291163	PVC Strips punched and assembled	225 cm	30 cm			1	



Fly Strip Curtain Set PVC

Protection against flies exclusively for use in agriculture or outdoors in other areas of application.

- airy strip curtain for keeping insects away from the stables
- with punched openings for more air circulation in summer
- high light permeability
- rounded long edges
- high wear resistance
- problem-free and easy fastening thanks to hook strips and hanging panels
- metal parts made from high-quality AISI 304 stainless steel
- Operating ambient temperature: -20 - 50 °C



Set consisting of: 5 x PVC strips punched, 30 x 225 cm, 3 mm thick, 5 x hanging panels 30 cm, 2 x hook strips (total length 130 cm)

Hanging panels pre-mounted on PVC strips

Ref. no.			€
291165	1	16	



Ref. no.	Description	Length	Width	MOQ	Pieces / unit		€
291154-1	Screw and Nut Set for Hanging Panels			1 pouch	8 / pouch	1	
291166	PVC Strips punched and assembled	225 cm	30 cm			1	



Scratch Mat

- made from natural rubber material
- mobile and soft nubs provide optimum coat care without risk of skin irritation
- rectangular shape with many mounting holes for stable mounting
- multi-functional applications such as flat on the wall or around pillars, posts or corners
- not suitable for adult cattle



Ref. no.	Colour	Length	Width			€
32678	black	40 cm	30 cm	1/12	240	
32689	black	60 cm	40 cm	1/6	168	

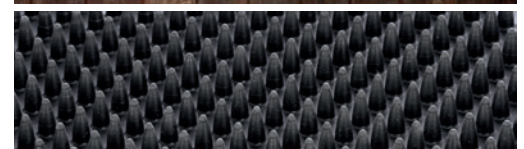

Scratch and Cleaning Mat

KratzPad

the flexible mat for natural coat care - without any tools

Simple, flexible and safe: the scratch and cleaning mat for horses and other animals with the skin-protecting structure. Thanks to its flexible design, can be easily installed on flat surfaces, over corners or on trees or posts.

- the mat's special structure prevents wounds and scratches to the animal, even with constant rubbing
- easy to install in stables, on fences, on tree trunks, on posts, on walls, etc.
- protects your infrastructure: nibbled box doors, damaged fence posts or nibbled tree bark can be easily avoided with the mat
- made from durable polyethylene
- not suitable for adult cattle



Made in the EU



easy mounting with screws or nails

Ref. no.	Colour	Length	Width			€
3282838	green	40 cm	60 cm	1/10	400	
3282839	green	55 cm	90 cm	1/10	120	

Scratch Brush

- ensures ideal fur cleaning and care
- head and throat in particular can be cleaned
- high-quality bristles firmly anchored in the body guarantee long-lasting use
- suitable for cattle and calves, horses, etc.
- proven many times over
- suitable for indoor and outdoor use
- various mounting options (walls, corners, stables, posts)
- countersunk fastening holes prevent possible injury to the animals

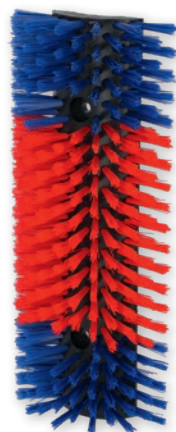

TV

Made in Germany



Ref. no.	Colour	Width	Height	Depth	Bristle material	Bristle length			€
293100	red / blue	22 cm	50 cm	9 cm	Polyamide	5 cm	1	100	



Scratch brush flexible

- allows breed-specific scrubbing of head and body sides • ensures ideal fur cleaning and care
- 3-part design offers flexible adaptation to different mounting locations • can be mounted flat on the wall or curved around corners, posts • suitable for cattle and calves, horses, etc.
- includes fastening material

New product NEW



Ref. no.	Colour	Width	Height	Depth	Bristle material	Bristle length		€
293111	red	30 cm	43 cm	9,5 cm	Polyamide	5,5 cm	1	

Scratch Brush XL

- allows breed-specific scrubbing of head and body sides • ensures ideal fur cleaning and care • high-quality bristles firmly anchored in the body guarantee long-lasting use • suitable for cattle and calves, horses, etc. • proven many times over • suitable for indoor and outdoor use • various mounting options (walls, corners, stables, posts) • countersunk fastening holes prevent possible injury to the animals



Made in Germany



Ref. no.	Colour	Width	Height	Depth	Bristle material	Bristle length			€
293105	red / blue	32 cm	50 cm	11 cm	Polyamide	6 cm	1	57	

Post Scrubber HAPPYCOW

- Scratch Brush for Outdoor Use
- available in 2 sizes (Maxi and Mini)
- for floor/ground installation on compacted surfaces or pasture land
- robust, hot-dip galvanised metal structure
- high-quality, resistant bristles
- 19 Brush Rings (Maxi) or Brush Rolls (Mini), both replaceable

18650: Base anchor set for pasture Installation optionally available

Technical data	18650	18660
Brush length	1.000 mm	600 mm
Ø brush	500 mm	430 mm
Bristle material	Polypropylene	Polypropylene

Ref. no.	Description	Colour	Height			€
18650	Maxi	red / blue	163 cm	1	2	
18660	Mini	red / blue	100 cm	1	2	



Made in Germany



Ref. no.	Description	Colour	Material	suitable for	MOQ	Pieces / unit		€
18851	Spare Brush HAPPYCOW MidiSwing	red / blue		18850, 18660		1		
18652	base anchor set for post scrubber Maxi		galvanised metal	18650		1		
18651-2	Brush Rings for Post Scrubber Maxi	blue		18650	1 pack	8 / pack	1	
18651-3	Brush Rings for Post Scrubber Maxi	red		18650	1 pack	11 / pack	1	

LED Outdoor Spotlight SolarLED Elio

- Solar battery light with external solar module • incl. motion sensor and brightness sensor
- with remote control for setting brightness and mode • Cable length: 5 m • removable lithium-ion battery • Tilt angle of light and solar module individually adjustable

4 operating modes:

- manual operation (on/off) • Timer operation (light switches on at dusk for the selected period (3 h/5 h/8 h)) • Automatic operation (light switches to 100 % brightness at dusk and gradually reduces to 30 % brightness) • Sensor operation (20 % brightness, 100 % brightness for approx. 15s when motion is detected)

available from: February 2025

Technical data	
Luminous efficacy	150 lm/W
Light angle (half intensity angle)	120 °
Material	ABS plastic / tempered glass
Battery rated voltage	3,7 V
Battery technology	Li-Ion
Battery capacity	15.000 mAh
Battery charge time	4 - 6 h
Hours of light	approx. 11 h
Solar module type	monocrystalline
Output solar module	15 W
Rated voltage solar module	5 V
Protection class	IP65



New product

NEW

Ref. no.	Output	Length	Width	Height	Luminous flux	Colour temperature		€
345696	8 W	27 cm	4,9 cm	30,6 cm	1.200 lm	4.000 K	1/5	

Ref. no.	Description	Length	Width	Height		€
345696-1	Solar Panel	390 mm	235 mm	17 mm	1/10	
345696-2	Replacement/extension cable	5 m			1/20	

LED Outdoor Spotlight SolarLED Solina

- compact solar battery light with integrated solar module • incl. motion sensor • Adjustable light colour (warm white, neutral white, cool white) • removable lithium-ion battery with USB-C charging port • Tilt angle of light and solar module individually adjustable

4 operating modes:

- 3 % brightness, 100 % brightness for approx. 30s when motion is detected
- Light off, 100 % brightness for 30s when motion is detected • 3 % brightness, no motion detection • Light off

available from: February 2025

Technical data	
Luminous efficacy	123 lm/W
Light angle (half intensity angle)	120 °
Material	ABS plastic / Polycarbonate
Battery rated voltage	3,7 V
Battery technology	Li-Ion
Battery capacity	2.600 Ah
Hours of light	approx. 8 h
Solar module type	polycrystalline
Output solar module	2 W
Rated voltage solar module	5,5 V
Protection class	IP54



New product

NEW

Ref. no.	Output	Length	Width	Height	Luminous flux	Colour temperature		€
345695	13 W	16,8 cm	4 cm	19,1 cm	1.600 lm	3.000 K / 4.000 K / 6.500 K	1/20	



LED Flood Light Comfort Pro

The integrated lens optics of the high-quality LED floodlight provide extremely homogeneous illumination, and at the same time reduce glare and light/shade contrasts. This makes it ideal for the focused, convenient illumination of riding areas and other spaces indoors and outdoors.

- integrated lens optic ensures extremely broad and front-facing lighting
- Light is directed to where it is needed – low light pollution
- Reduces glare and light-shadow contrast
- protected against temporary immersion and dust-proof (IP67 protection class)
- flicker-free, so also suitable for animals with high visual acuity
- cover made from hardened glass
- with integrated mounting bracket and access lines 1.5 m
- Can be mounted on floodlight towers with optional adapter (345413)
- suitable for indoor and outdoor use
- 5-year warranty

5-year warranty



New product

NEW



200 W



100 W



50 W

extremely wide beam directed forwards

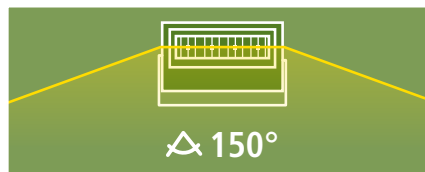
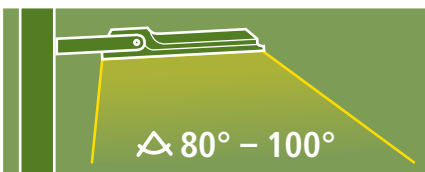

Technical data

Voltage	100 - 277 V AC
Mains frequency	50 - 60 Hz
Luminous efficacy	160 lm/W
Light angle (half intensity angle)	150 °
Chip service life (L70)	> 100.000 h
Dimming function	1...10 V, 10 V PWM, 0 - 100 kΩ resistance
Material	Aluminium, powder-coated / Polycarbonate / stainless steel / tempered glass
Operating ambient temperature	-40 - 50 °C
Colour rendering (CRI)	Ra > 80
Power factor	> 0,9
Impact resistance	IK08
Protection class	IP67



Perfect light for horse and rider with Comfort Pro 200 W

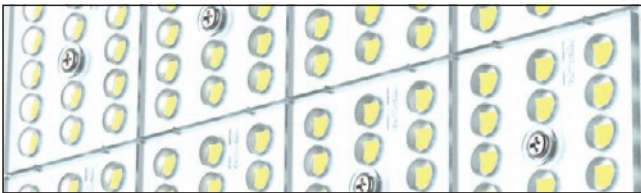

As steppe animals, horses have a high need for light and, as prey animals, have a very wide field of view (340 °). They see in mainly shades of green and blue and only adapt slowly to changes between light and dark. The LED floodlight Comfort Pro 200 W is adapted to these needs and special features and is therefore perfectly suited as a riding arena light. It provides high light intensity within a horse-friendly light spectrum. Homogeneous illumination reduces glare and light/shadow contrast, only directing the light to where it is needed. Perfect lighting for horse and rider! Find out more in the "LED Lighting for Horses" brochure.

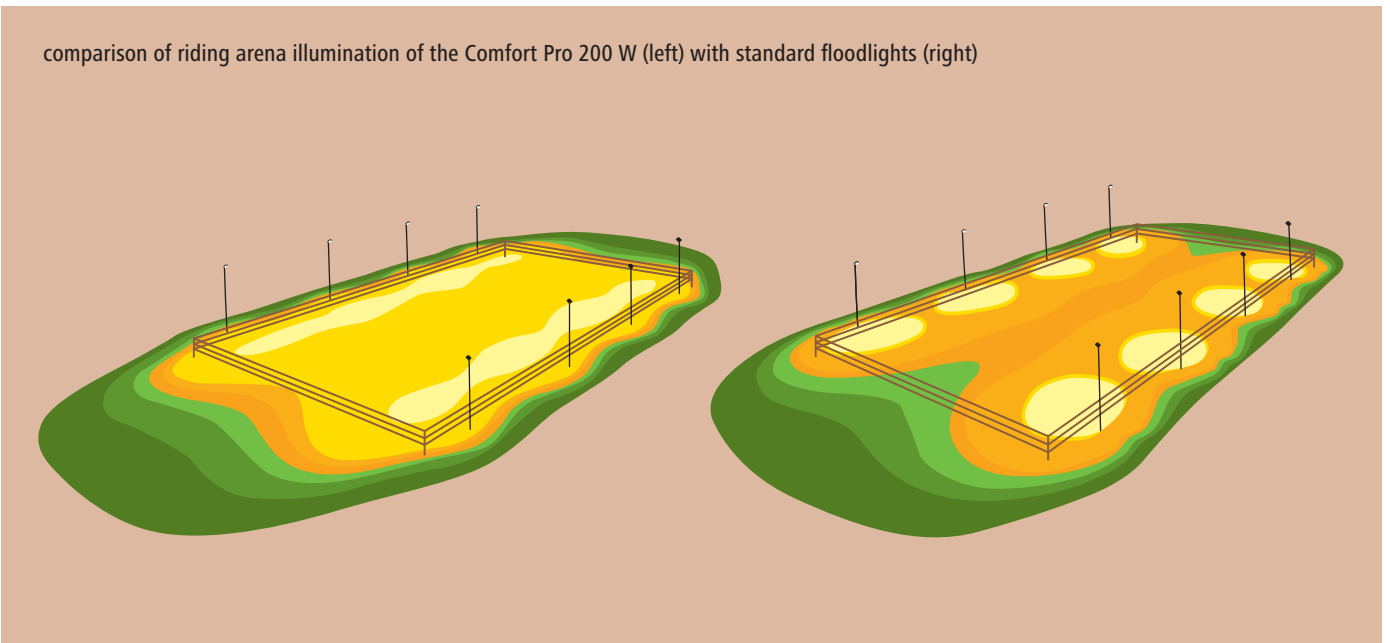

comparison of riding arena illumination of the Comfort Pro 200 W (left) with standard floodlights (right)



available from: February 2025

Ref. no.	Output	Length	Width	Height	Dimming function	Luminous flux	Colour temperature		€
345410	50 W	21,7 cm	32,3 cm	5,1 cm	dimnable	8.000 lm	5.700 K	1/5	
345411	100 W	34,3 cm	36,9 cm	5,6 cm	dimnable	16.000 lm	5.700 K	1/3	
345412	200 W	39,3 cm	42,2 cm	5,8 cm	dimnable	32.000 lm	5.700 K	1/2	
Ref. no.	Description								€
345413	Mounting adapter for flood light towers							1/20	



LED Outdoor Spotlight

- for even lighting of stalls, barns, sheds, farmyards, gardens etc.
- with energy-efficient, SMD LED chips
- up to 90 % less power consumption
- high light power - 120 lm/W
- adjustable angle, thanks to movable installation bracket
- robust housing made from cast aluminium with safety glass
- protected against dust and spray
- incl. 1 m connection cable
- Detection area, switch-on duration and switch-on brightness adjustable (models with motion detector)
- GS-tested
- 2-year warranty



Technical data	
Voltage	220 - 240 V
Mains frequency	50 - 60 Hz
Luminous efficacy	120 lm/W
Light angle (half intensity angle)	110 °
Chip service life (L70)	~ 30.000 h
Material	Die-cast aluminium
Colour rendering (CRI)	Ra > 80
Cable length	100 cm
Protection class (without motion sensor)	IP65
Protection class (with motion sensor)	IP44

Ref. no.	Description	Output	Width	Height	Depth	Dimming function	Luminous flux	Colour temperature			€
345660	without motion sensor	10 W	8,8 cm	3,2 cm	6,2 cm	cannot be dimmed	1.200 lm	5.000 K	1/50	1.200	
345661	without motion sensor	20 W	10 cm	3,5 cm	7 cm	cannot be dimmed	2.400 lm	5.000 K	1/30	1.200	
345662	without motion sensor	30 W	13,5 cm	3,5 cm	11 cm	cannot be dimmed	3.600 lm	5.000 K	1/20	600	
345663	without motion sensor	50 W	18 cm	3,5 cm	14,3 cm	cannot be dimmed	6.000 lm	5.000 K	1/18	648	
345664	without motion sensor	100 W	21 cm	16,5 cm	3,5 cm	cannot be dimmed	12.000 lm	5.000 K	1/10	350	
345665	with motion detector	10 W	8,8 cm	4,5 cm	12,5 cm	cannot be dimmed	1.200 lm	5.000 K	1/40	960	
345666	with motion detector	20 W	10 cm	5 cm	14 cm	cannot be dimmed	2.400 lm	5.000 K	1/30	540	
345667	with motion detector	30 W	13,5 cm	5 cm	17,5 cm	cannot be dimmed	3.600 lm	5.000 K	1/30	540	
345668	with motion detector	50 W	18 cm	5 cm	20,7 cm	cannot be dimmed	6.000 lm	5.000 K	1/16	384	

LED Oval Light

- ideal for passage areas, garage, basement, etc.
- sturdy plastic housing with glazed cover
- splash-proof
- ceiling or wall mounting
- with energy-efficient, SMD LED chips
- up to 80 % less power consumption
- suitable for outdoor use
- 2-year warranty

Technical data	345606
Voltage	220 - 240 V AC
Mains frequency	50 - 60 Hz
Luminous efficacy	80 lm/W
Light angle (half intensity angle)	100 °
Chip service life (L70)	> 30.000 h
Colour rendering (CRI)	Ra > 80
Protection class	IP54



Ref. no.	Output	Length	Width	Height	Dimming function	Luminous flux	Colour temperature			€
345606	5,5 W	16,9 cm	11,5 cm	7,6 cm	cannot be dimmed	450 lm	6.500 K	1/12/24	432	



Control for LED lighting

This lighting control allows you to switch the artificial lighting on or off, on a timer and regardless of existing daylight, or even achieve a constant light level (e.g. min. 200 lux) through automatic dimming. This means it ensures ideal lighting conditions throughout the day and year while minimising electricity consumption. Comfort for animals and humans!

- controls lighting dependent on time and/or daylight
- four different lighting circuits (groups) can be independently controlled, two of which with a dimming function
- suitable for LED lights with 1...10V interface
- standard surface-mount housing for mounting in the equipment room
- Dust and moisture protection (IP65)
- suitable e.g. for up to 50 150 watt lights (up to 15 lights on the dimmable circuits 1 and 2, and up to 10 lights on circuits 3 and 4)
- supplied with a light sensor (can request up to four light sensors)
- input for up to four button signals
- easy to use with display and three buttons
- with extensive documentation and terminal description
- Housing material: Plastic



easy to install by your electric company

Technical data	345000
Supply voltage	230 V / 400 V
Fuse	B16 A
Pole Connectors	3-pin
Max. current value per output	16 A
Max. total power circuit 3 and 4	16 A
Number of circuits	4
Number of dimmable circuits	2
Max. switching capacity	11 kVA
Dimming function circuit 1 and 2	1...10 V
Number of max. light sensors	4
Number of max. button signals	4
Protection class	IP65

Ref. no.	Material	Width	Height		€
345000	Plastic	300 mm	450 mm	1	

Ref. no.	Description	Length	Width	Height		€
345001	Sensor for control	11 cm	6,5 cm	3,5 cm	1	





LED light HiLED Pro

The high-quality LED light is suitable for agriculture as well as for many other applications in trade and industry.

- resistant to ammonia
- extremely efficient through high lumen output
- special heat sink shape for optimised heat dissipation
- protected against powerful water jets and dust-proof (IP65 protection class)
- flicker-free, so also suitable for animals with high visual acuity
- cover made from hardened glass
- with D marking according to DIN EN 60598-2-24, therefore suitable for areas at risk of fires due to combustible dusts or fibres (hay storage, feed, litter, etc.)
- suitable for outdoor use
- 5-year warranty

5-year warranty



New product

NEW



available from: February 2025

Technical data	
Voltage	100 - 277 V AC
Mains frequency	50 - 60 Hz
Luminous efficacy	160 lm/W
Light angle (half intensity angle)	120 °
Chip service life (L70)	> 80.000 h
LED type	SMD
Dimming function	1...10 V, 10 V PWM, 0 - 100 kΩ resistance
Material	Die-cast aluminium with anti-corrosion coating / tempered glass / stainless steel
Operating ambient temperature	-30 - 50 °C
Colour rendering (CRI)	Ra > 80
Power factor	> 0,9
Protection class	IP65

Ref. no.	Output	Length	Width	Height	Dimming function	Luminous flux	Colour temperature		€
345920	100 W	15,5 cm	23,8 cm	23,8 cm	dimnable	16.000 lm	5.700 K	1/8	
345921	150 W	16,2 cm	25,5 cm	25,5 cm	dimnable	24.000 lm	5.700 K	1/8	
345922	200 W	16,6 cm	29,9 cm	29,9 cm	dimnable	32.000 lm	5.700 K	1/4	

Ref. no.	Description	Colour	Material		€
345923	Mounting bracket for ceiling and wall mounting LED Light HiLED Pro	black	metal	1/20	



LED light MultiLED Pro

The high-quality LED light is suitable for agriculture as well as for many other applications in trade and industry. With the individually rotatable modules, the light offers customisable light distribution and can be used extremely variably as a floodlight or high bay floodlight.

- resistant to ammonia
- extremely efficient through high lumen output
- special heat sink shape for optimised heat dissipation
- protected against powerful water jets and dust-proof (IP65 protection class)
- flicker-free, so also suitable for animals with high visual acuity
- cover made from hardened glass
- with D marking according to DIN EN 60598-2-24, therefore suitable for areas at risk of fires due to combustible dusts or fibres (hay storage, feed, litter, etc.)
- suitable for outdoor use
- 5-year warranty

5-year warranty



New product

NEW



available from: February 2025

Technical data	
Voltage	100 - 277 V AC
Mains frequency	50 - 60 Hz
Luminous efficacy	160 lm/W
Light angle (half intensity angle)	120 °
Chip service life (L70)	> 80.000 h
LED type	SMD
Dimming function	1...10 V, 10 V PWM, 0 - 100 kΩ resistance
Material	Die-cast aluminium with anti-corrosion coating / tempered glass / stainless steel
Operating ambient temperature	-40 - 50 °C
Colour rendering (CRI)	Ra > 80
Power factor	> 0,9
Protection class	IP65

Ref. no.	Description	Output	Length	Width	Height	Dimming function	Luminous flux	Colour temperature		€
345975	2 swivel modules	150 W	12,7 cm	35,3 cm	30 cm	dimnable	19.500 lm	5.700 K	1/4	
345976	3 swivel modules	225 W	13,5 cm	44,1 cm	30 cm	dimnable	36.000 lm	5.700 K	1/3	



LED Tube EcoTUBE Plus

- Lamp tube made out of glass with special plastic coating to prevent sagging while also ensuring optimal splinter protection
- very high light angle ensures particularly uniform illumination
- flicker-free, thus also for poultry with high visual acuity
- very high light output
- extremely efficient through high lumen output
- only suitable for lights with conventional electro-magnetic ballasts (conventional ballasts/low-loss ballasts).
- TÜV tested
- 5-year warranty

New product **NEW**



Technical data	
Voltage	220 - 240 V AC
Mains frequency	50 - 60 Hz
Light angle (half intensity angle)	210 °
Chip service life (L70)	> 50.000 h
Colour rendering (CRI)	Ra > 80
Lamp Base	G13
Bulb shape	T8



flicker-free

5-year warranty **5**



Ref. no.	Output	Length	Dimming function	Luminous flux	Colour temperature		€
345654	24 W	150 cm	cannot be dimmed	4.000 lm	4.000 K	1/10	
345652	24 W	150 cm	cannot be dimmed	4.000 lm	6.500 K	1/10	
345655	18 W	120 cm	cannot be dimmed	3.000 lm	4.000 K	1/10	
345653	18 W	120 cm	cannot be dimmed	3.000 lm	6.500 K	1/10	

LED moisture-proof lamp SlimLINE

- for lighting stables, riding halls, barns, industrial buildings and warehouses, workshops, cellars, etc.
- for low to medium ceiling heights and ideal as a replacement for fluorescent tubes
- flicker-free, so ideally suitable for poultry
- uniform and glare-free illumination due to a frosted cover
- stable, shock-resistant housing made from polycarbonate
- protected against water jets and dust-proof (IP66 protection class)
- incl. connection cable and stainless steel mounting clips
- with D marking according to DIN EN 60598-2-24, therefore suitable for areas at risk of fires due to combustible dusts or fibres (hay storage, feed, litter, etc.)
- 3-year warranty

Technical data	
Voltage	220 - 240 V AC
Mains frequency	50 - 60 Hz
Luminous efficacy	140 lm/W
Light angle (half intensity angle)	120 °
Chip service life (L70)	> 50.000 h
Material	Polycarbonate / stainless steel
Operating ambient temperature	-20 - 40 °C
Colour rendering (CRI)	Ra > 80
Power factor	> 0,9
Protection class	IP66

available from: February 2025

New product **NEW**

3-year warranty **3**



Ref. no.	Output	Length	Width	Height	Dimming function	Luminous flux	Colour temperature		€
345461	35 W	120 cm	5,2 cm	5,4 cm	cannot be dimmed	4.900 lm	6.000 K	1/12	
345462	45 W	150 cm	5,2 cm	5,4 cm	cannot be dimmed	6.300 lm	6.000 K	1/12	

Moisture-proof Diffuser Light for LED Tubes

- only suitable for T8 LED tubes
- no bridging starter required
- protected against powerful water jets and dust-proof (IP65 protection class)
- unbreakable housing with a high resistance to ammonia
- incl. installation clips made of stainless steel
- with D marking according to DIN EN 60598-2-24, therefore suitable for areas at risk of fires due to combustible dusts or fibres (hay storage, feed, litter, etc.)

Technical data	
Voltage	220 - 240 V AC
Mains frequency	50 - 60 Hz
Max. output of the LED tubes used	18 W
Lamp Base	G13
Protection class	IP65
Protection class	I

Light source not included!

Ref. no.	Colour	Length			€
345670	grey	120 cm	1/12	180	
34567	grey	150 cm	1/9	135	



LED moisture-proof lamp FarmLINE

Perfect for rough conditions in wet, moist or dusty environments!

- for lighting stables, riding halls, industrial buildings and warehouses, barns, workshops, etc.
- with integrated high-performance LED chips (no fluorescent or LED tubes required)
- protected against powerful water jets and dust-proof (IP65 protection class)
- with D marking according to DIN EN 60598-2-24, therefore suitable for areas at risk of fires due to combustible dusts or fibres (hay storage, feed, litter, etc.)
- stable, shock-resistant housing made from polycarbonate
- uniform and glare-free illumination due to a frosted cover
- incl. installation clips made of stainless steel
- 3-year warranty

Technical data	
Voltage	220 - 240 V AC
Mains frequency	50 - 60 Hz
Luminous efficacy	128 lm/W
Light angle (half intensity angle)	120 °
Chip service life (L70)	> 50.000 h
Material	Polycarbonate / stainless steel
Operating ambient temperature	-20 - 40 °C
Colour rendering (CRI)	Ra > 80
Power factor	> 0,9
Protection class	IP65
Protection class	I



New product **NEW**



3-year warranty



Ref. no.	Output	Length	Width	Height	Dimming function	Luminous flux	Colour temperature		€
345470	25 W	119 cm	9,5 cm	7,5 cm	cannot be dimmed	3.200 lm	6.000 K	1/6	
345471	50 W	149 cm	9,5 cm	7,5 cm	cannot be dimmed	6.400 lm	6.000 K	1/6	

LED light HiLED Evo

The compact LED light is the perfect choice for particularly cost-effective illumination in many areas of application in moderately used industrial buildings, as well as in commerce and industry.

- not recommended for use in stalls/stables with high concentrations of ammonia
- extremely efficient through high lumen output
- compact and efficient design
- protected against water jets and dust-proof (IP66 protection class)
- Cover made from polycarbonate
- 3-year warranty



available from: February 2025

Technical data	
Voltage	100 - 240 V AC
Mains frequency	50 - 60 Hz
Luminous efficacy	150 lm/W
Light angle (half intensity angle)	120 °
Chip service life (L70)	> 50.000 h
LED type	SMD
Dimming function	1...10 V, 10 V PWM, 0 - 100 kΩ resistance
Material	Die-cast aluminium with anti-corrosion coating / Polycarbonate / stainless steel
Operating ambient temperature	-30 - 50 °C
Colour rendering (CRI)	Ra > 80
Power factor	> 0,9
Protection class	IP66

New product **NEW**

3-year warranty



Ref. no.	Output	Length	Width	Height	Dimming function	Luminous flux	Colour temperature		€
345930	75 W	15,8 cm	26,5 cm	26,5 cm	dimmable	11.250 lm	5.700 K	1/2	
345931	125 W	15,8 cm	26,5 cm	26,5 cm	dimmable	18.750 lm	5.700 K	1/2	
345932	175 W	16 cm	30 cm	30 cm	dimmable	26.250 lm	5.700 K	1/2	

Ref. no.	Description	Colour	Material		€
345933	Mounting bracket for ceiling and wall mounting LED Light HiLED Evo	black	metal	1/36	



LED Torch MiniFire 300

- powerful, rechargeable LED torch with 300 lumens • robust aluminium housing with a very slim design • stepless focus function • with clip for easy attachment to belts, shirt pockets, etc. • ideal for working in dark, cramped workplaces: maintenance work, inspection work, etc.
- USB-C charging interface (rechargeable Li-Ion battery included) • incl. USB cable



Technical data	
Light levels	3 light levels
Light level modes	100 % / 50 % / Flashing
Battery charge time	1,5 h
Hours of light	~ 3 h
Protection class	IP44

New product NEW



Ref. no.	Colour	Length	Width	Luminous flux		€
345624	black	10,3 cm	1,6 cm	300 lm	1/20/40	

LED Torch ProFire 1800

- powerful, rechargeable LED torch with 1,800 lumens • robust aluminium housing • stepless focus function • with wrist loop • ideal for working or activities in dark places: workshop, maintenance work, household, outdoors, camping • USB-C charging interface (rechargeable Li-Ion battery included) • incl. USB cable



Technical data	
Light levels	5 light levels
Light level modes	100 % / 50 % / 25 % / Flashing / SOS
Battery charge time	5 h
Hours of light	~ 5 h
Protection class	IP44

New product NEW



Ref. no.	Colour	Length	Width	Luminous flux		€
345625	black	17 cm	3,9 cm	1.800 lm	1/20/40	

LED Torch FlexFire 1000

- powerful, rechargeable LED torch with 1,000 lumens • robust aluminium housing • Light head with 90° rotation function • with clip for easy attachment to belts, shirt pockets, etc. • with magnet at the end of the housing for flexible attachment to metallic surfaces • ideal for working or activities in dark places: workshop, maintenance work, inspection work, household, outdoors, camping • USB-C charging interface (rechargeable Li-Ion battery included) • incl. USB cable



New product NEW

Technical data	
Light levels	5 light levels
Light level modes	100 % / 50 % / 25 % / Flashing / SOS
Battery charge time	5 h
Hours of light	~ 5 h
Protection class	IP44



Ref. no.	Colour	Length	Width	Luminous flux		€
345626	black	13,7 cm	2,5 cm	1.000 lm	1/20/40	

Mobile LED spotlight WorkFire 2200

- powerful, rechargeable LED spotlight with 2,200 lumens • 90° fold-out stand for standing or hanging • Snap hook ring and integrated magnet for flexible mounting • robust, compact housing with edge protection • with charge status indicator and power bank function • ideal for working in dark places: workshop, construction site, outdoors, camping • USB-C charging interface (rechargeable Li-Ion battery included) • incl. USB cable

New product **NEW**



Technical data	
Light levels	4 light levels
Light level modes	25 % / 50 % / 100 % / Flashing
Battery charge time	2,5 h
Hours of light	approx. 9 h
Protection class	IP54

Ref. no.	Colour	Output	Length	Width	Height	Luminous flux		€
345627	black / grey	20 W	11,5 cm	11,5 cm	4,7 cm	2.200 lm	1/30	

LED hand lamp WorkFire 350

- rechargeable LED hand lamp with two light sources and flexible mounting options • side main light (5 W COB LED, 350 lumens) and additional head light (3 W LED, 120 lumens) • Dimming function: Luminosity levels can be continuously adjusted via push buttons • can be used flexibly and according to the work location thanks to the 360° rotatable hook, 180° foldable holding foot and two integrated magnets • with clip for easy attachment to belts, shirt pockets, etc. • with charge status indicator and power bank function • ideal for working in dark places: workshop, maintenance work, inspection work, household, outdoors, camping • USB-C charging interface (rechargeable Li-Ion battery included) • incl. USB cable

New product **NEW**



Technical data	
Light levels	stepless
Battery charge time	2,5 h
Hours of light	~ 4 h
Protection class	IP22

Ref. no.	Colour	Length	Width	Luminous flux		€
345628	black	19 cm	5,8 cm	350 lm	1/50	



Digital Suspension Scale DigiScale 50

- especially easy handling • high accuracy level • with removable measuring tape (length: 100 cm) • temperature display (°C)
- automatic switch-off function • tare function • Data hold function • can be calibrated • rapid and reliable weighing • for non-calibrated weighing • operated with: 2 x 3 V - CR2032 Lithium • Battery included • includes operating instructions

Technical data	29920
Precision class	OIML III
Display	LCD 4-digit
Number height	15 mm
tare weight function	100 % of the weighing range
Weight	185 g
Operating ambient temperature	0 - 40 °C
Weighing unit can be switched	kg / lb / oz
Battery Operation	2 x 3 V - CR2032 Lithium



up to 50 kg



Ref. no.	Description		€
29918	Button Battery 3 Volt	1/20	

Ref. no.	Colour	Material	Scales readability (d)	Weighing range		€
29920	black	Plastic	20 g	0,4 - 50 kg	1/10/60	

Digital Suspension Scale DigiScale 300

- for professional use: quick, accurate and sturdy • non-breakable casing, rust proof, anti-static and light
- suspension hooks and shackles can be rotated 360° • automatic switch-off function • tare function • rapid and reliable weighing • for non-calibrated weighing • with hook fastening • includes operating instructions

Technical data	29921
Precision class	OIML III
Display	LED 5-digit
Number height	15 mm
tare weight function	100 % of the weighing range
Operating ambient temperature	-10 - 40 °C
Weighing unit can be switched	kg / lb
Battery technology	Li-Ion
Battery voltage	7,4 V
Battery capacity	2 Ah

up to 300 kg



Ref. no.	Material	Scales readability (d)	Weighing range			€
29921	Plastic	100 g	2 - 300 kg	1/10	80	

Digital Suspension Scale DigiScale 1000

- for professional use: quick, accurate and sturdy • non-breakable casing, rust proof, anti-static and light • 360° swivel hook • automatic switch-off function • Hold function • tare function • save, retrieve and sum up values • rapid and reliable weighing • for non-calibrated weighing • with hanging hook • includes operating instructions

Technical data	29922
Precision class	OIML III
Display	LED 5-digit
Number height	30 mm
tare weight function	100 % of the weighing range
Overload capacity	400 %
Operating ambient temperature	-10 - 40 °C
Weighing unit can be switched	kg / lb
Battery voltage	6 V
Battery capacity	10 Ah

up to 1,000 kg



Ref. no.	Scales readability (d)	Weighing range			€
29922	500 g	50 - 1.000 kg	1/4	64	

Animal Scales

The PS animal scale represents simple, easy and precise weighing. It boasts extremely easy installation and operation and is also virtually maintenance-free.

- operated with: 4 x 1.5 V - AAA (Micro) Alkaline
- Battery and power pack included
- includes operating instructions

Platform PS 3000:

- capacity: 1,500 kg • extremely robust, powder-coated steel construction with large surface, designed for large animals • the integrated anti-slip rubber mat offers exceptionally good grip

Display unit:

- LCD (PS 1000/2000) or LED (PS 3000) with digital display • 5 m connecting cable to platform • 230 V mains or battery operation (power pack and batteries included) • RS232 interface (full duplex) for the connection of printers, external displays, etc. (RS232 cable included) • automatic shut-off • housing of stainless steel (PS 1000/2000) or high-quality ABS plastic (PS 3000) • wall bracket included • stand (height 1 m) optionally available

Functions:

- Hold (animal weighing function): The average weight measured in the first seconds after the animal walks onto the scale remains on the display until the next animal walks onto the platform. ideal for weight fluctuations when restless animals are being weighed • Print: Send data via RS232 interface • Units: Toggle display between kg and lb
- Tare: Tare function (display of net weight)

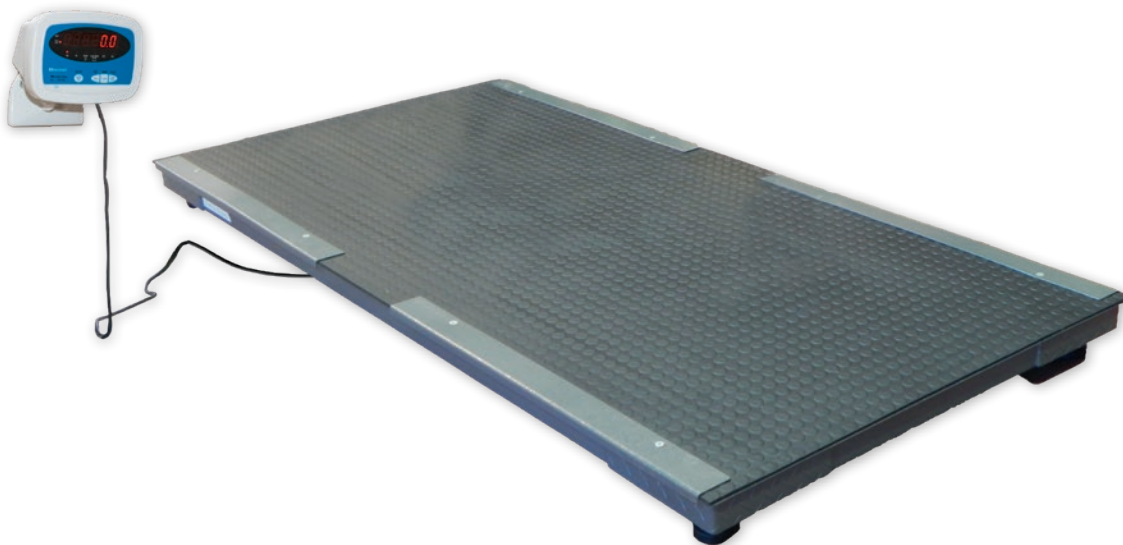

Technical data	291312
Display	LED
tare weight function	100 % of the weighing range
Overload capacity	150 %
Weighing platform	200 x 100 x 10 cm
Weight of weighing platform	135 kg
Weighing precision	+/- 1,5 kg
Weighing unit can be switched	kg / lb
Battery Operation	4 x 1.5 V - AAA (Micro) Alkaline





Ref. no.	Description	Scales readability (d)	Weighing range			€
291312	PS 3000	500 g	1.500 kg	1	7	

Ref. no.	Description		€
291314	Stand for Display Unit	1/5	



Suspended Dial Balance Premium

- for fast weight determination • for the economic control of feed • Mechanism and spring in quality workmanship • sturdy Plexiglass front and stable housing
- with metal hook

Ref. no.	Material	Scales readability (d)	Weighing range			€
29950	metal	20 g	5 kg	1/10	240	
29951	metal	50 g	10 kg	1/10	240	
29952	metal	100 g	25 kg	1/10	240	
29953	metal	200 g	50 kg	1/10	240	
29954	metal	500 g	100 kg	1/10	240	
2994	metal	1 kg	250 kg	1/5	280	

Ref. no.	Description		€
29904	Replacement Glass for Scales 5 - 250 kg	1/160	



Moisture level reader for hay and straw

- Portable digital device for the determination of moisture and temperature in pressed hay and straw • incl. 55 cm long measuring probe that registers changes in the electrical conductivity of hay and straw and turns them into moisture percentages • can store up to 50 measurement results
- operated with: 1 x 9 V - Block 6LF22 Alkaline-manganese • Battery included • 3-year warranty

Technical data		29356
Battery Operation		1 x 9 V - Block 6LF22 Alkaline-manganese
Display		LCD 3-digit
Temperature measuring range		1 - 100 °C
Moisture measurement accuracy		10 - 80 %
Sensor cable length		140 cm

Ref. no.	Colour		€
29356	yellow	1/20	



Spray Rinser Komfort

- high quality metal spray shower • non-slip and abrasion-resistant surface for comfortable and fatigue-free working • steplessly adjustable nozzle from full jet to fine mist • incl. 3-step hose connection and standardised hose coupling (1.2")

Ref. no.	Connection	Colour			€
15741	1/2"	black	1/24	792	

Ref. no.	Description	Colour	Material		€
15731	Hose Connector 3-tier	black	Plastic	1/10/500	
15732	Hose Coupling	black	Plastic	1/10/500	



AKS Liquid

AKS liquid protects your horse from picking up foreign objects such as swarf, fibres or other objects and thus prevents serious injuries or illnesses. For use on larger areas, doors, walls and pasture fences. AKS contains natural extract of pepper (capsaicin).



Ref. no.	Contents			€
3227325	500 ml / Bottle	1/6	600	

AKS Paste

• Protects the horse from injuries through swallowing or biting material • AKS protects immediately and reliably



Ref. no.	Contents			€
3227324	200 ml / Can	1/12	900	

Stable Blackboard

- Material: plastic, painted
- printed on one side

Name:	geb.:
Vater: von:	aus:
Mutter: von:	aus:
Zuchtgebiet:	
Besitzer:	
Tierarzt:	
Hufschmied:	

Ref. no.	Print	Colour	Length	Width		€
3251	for horses	black	30 cm	20 cm	1/25	

Chalk marker

• chalk marker with round tip • odour-neutral, water-based, liquid chalk • can be damp-wiped from virtually any sealed surface such as glass, windows or boards • Line thickness approx. 2-3 mm • pump system, shake well before use, open cap and pump



Ref. no.	Colour	Line weight	MOQ	Pieces / unit		€
29629	white	thin	10 pieces	10 / pack	1/10/400	
29629/1	white	thin	1 pack	1 / pack	1	

Snap-hook

- Material: galvanised metal



Ref. no.	Length	Material thickness	MOQ	Pieces / unit		€
3092	60 mm	6 mm	1 pack	6 / pack	1	
3093	70 mm	7 mm	1 pack	6 / pack	1	
3094	80 mm	8 mm	1 pack	6 / pack	1	
3095	90 mm	9 mm	1 pack	3 / pack	1	
3096	100 mm	10 mm	1 pack	3 / pack	1	

Bar ring with wood screw

- Ring thickness: 10 mm • Material: galvanised metal



Ref. no.	Length	Material thickness	MOQ	Pieces / unit		€
12282/2	80 mm	10 mm	1 pack	2 / pack	1	

Bar ring with threaded screw

- Ring thickness: 10 mm • Material: galvanised metal



Ref. no.	Length	Material thickness	MOQ	Pieces / unit		€
12281/2	120 mm	10 mm	1 pack	2 / pack	1	

Stable Bolt

- sturdy quality • Material: galvanised metal

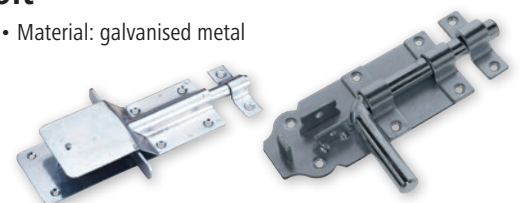

Ref. no.	Description		€
2984	with snap closure	1/30	
29841	with stud closure	1/30	

Water Bowl with Pipe Valve E21

- with drinking bowl made of stainless steel, pipe valve and robust cast iron body
- ideal for dairy cows, as results in a large water flow
- extra-large and wide bowl (Ø 27 cm, height 12 cm)
- Stainless steel ensures optimum water hygiene
- 4-point fastening on wall or pipe
- Fastening material not included

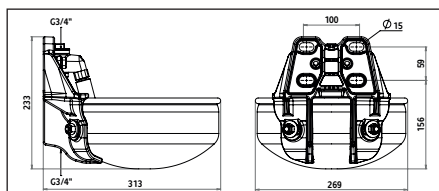

Technical data	221860	2218605
Connection option	from above or below	from above or below
Flow rate	14 L/min at 3 bar, 20 L/min at 5 bar	14 L/min at 3 bar, 20 L/min at 5 bar

Ref. no.	Water connection	Capacity			€
221860	G 1/2"	5 L	1	60	
2218605	G 3/4"	5 L	1	60	

Ref. no.	Description	Material	Frame height		€
22365	Pipe Mounting Brackets, in pairs	metal		1/25	
221971	Guard Size 2	hot-dip galvanised metal	20 cm	1/4	
221886	Valve			1/20	



22365



Water Bowl with Pipe Valve G51

- large drinking bowl made of grey cast iron
- high-quality enamelled surface
- easy to clean bowl shape
- for wall and pipe mounting

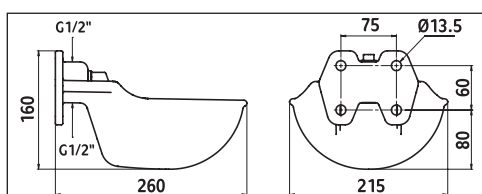

enamelled

Technical data	221851
Connection option	from above or below
Flow rate	8 L/min at 3 bar

Ref. no.	Colour	Water connection	Capacity			€
221851	black	G 1/2"	1,7 L	1	84	

Ref. no.	Description	Material	Connection	suitable for	Frame height		€
221885	Pipe Valve Set					1/20	
221886	Valve					1/20	
22365	Pipe Mounting Brackets, in pairs	metal				1/25	
221970	Guard Size 1	hot-dip galvanised metal			20 cm	1/4	
22209	Sealing plug	Plastic	1/2"	221500, 221800, 222000, 222500, 222005, 222010		1/200/1000	



22365



Drinking Bowls G20

- solid, enamelled grey cast body with particularly large, deep bowl
- Bowl diameter: 225 mm
- for wall and pipe mounting

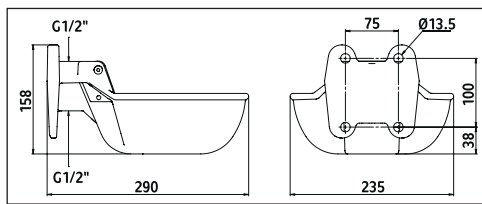

Technical data	222020
Dimensions (W x D x H)	23,5 cm x 29 cm x 15,8 cm
Connection option	from above or below
Water flow rate	3-way adjustable
Flow rate	7,5 - 11 l/min (3 bar)
Weight	7,4 kg

Ref. no.	Colour	Water connection	Capacity			€		
222020	black	G 1/2"	2 L	1	55			

Ref. no.	Description	Material	Connection	suitable for	Frame height		€
223426	Valve high-pressure	brass				1/20/200	
22365	Pipe Mounting Brackets, in pairs	metal				1/25	
221970	Guard Size 1	hot-dip galvanised metal			20 cm	1/4	
22209	Sealing plug	Plastic	1/2"	221500, 221800, 222000, 222500, 222005, 222010		1/200/1000	

Drinking Bowls Mod. 221500

- large drinking bowl made of grey powder-coated cast iron
- Stainless Steel Nose Paddle
- for wall and pipe mounting

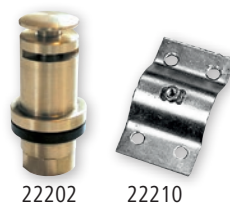
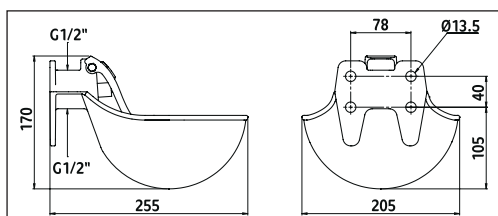

Technical data	
Dimensions (W x D x H)	20,5 cm x 25,5 cm x 17 cm
Connection option	from above or below
Flow rate	5 L/min at 3 bar
Weight	3,7 kg

Ref. no.	Colour	Water connection	Capacity	MOQ	Pieces / unit			€
221500	black	G 1/2"	1,45 L	2 pieces	2 / box	1/2	96	
221501	black	G 1/2"	1,45 L			1	105	

Ref. no.	Description	Material	Connection	suitable for	Frame height	MOQ	Pieces / unit		€
22202	Valve	brass						1/10/400	
22202/1	Valve	brass				1 pack	1 / pack	1	
22210	tube retaining plate	metal						1/100	
221970	Guard Size 1	hot-dip galvanised metal			20 cm			1/4	
22209	Sealing plug	Plastic	1/2"	221500, 221800, 222000, 222500, 222005, 222010				1/200/1000	

Water Bowl with Stainless Steel Tongue G16

- Drinking bowl made of grey cast iron, enamelled
- individually packed
- for wall and pipe mounting

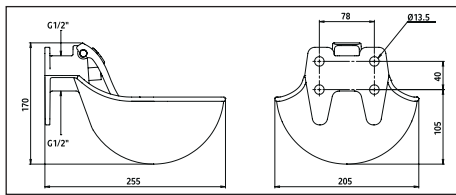

enamelled



Technical data	221600
Dimensions (W x D x H)	20,5 cm x 25,5 cm x 17 cm
Connection option	from above or below
Flow rate	5 L/min at 3 bar
Weight	3,7 kg

Ref. no.	Colour	Water connection	Capacity			€		
221600	black	G 1/2"	1,45 L	1	120			

Ref. no.	Description	Material	Connection	suitable for	Frame height	MOQ	Pieces / unit		€
22202	Valve	brass						1/10/400	
22202/1	Valve	brass				1 pack	1 / pack	1	
22210	tube retaining plate	metal						1/100	
221970	Guard Size 1	hot-dip galvanised metal			20 cm			1/4	
22209	Sealing plug	Plastic	1/2"	221500, 221800, 222000, 222500, 222005, 222010				1/200/1000	

Drinking Bowls Mod. 222000

- large drinking bowl made of grey powder-coated cast iron
- lockable paddle
- Nose Paddle Cast Iron
- for wall and pipe mounting

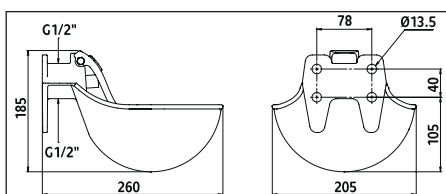

lockable paddle



Technical data	222000
Dimensions (W x D x H)	20,5 cm x 26 cm x 18,5 cm
Connection option	from above or below
Flow rate	5 L/min at 3 bar
Weight	4,5 kg

Ref. no.	Colour	Water connection	Capacity	MOQ	Pieces / unit			€
222000	black	G 1/2"	1,5 L	2 pieces	2 / box	1/2	96	

Ref. no.	Description	Material	Frame height	MOQ	Pieces / unit		€
22202	Valve	brass				1/10/400	
22202/1	Valve	brass		1 pack	1 / pack	1	
22210	tube retaining plate	metal				1/100	
221970	Guard Size 1	hot-dip galvanised metal	20 cm			1/4	

Drinking Bowls K75

- controllable water flow rate (up to max. 11 litres/minute)
- with outlet plug for easy cleaning • for wall and pipe mounting • Material: Polypropylene



Technical data	
Connection option	from above or below
Flow rate	11 L/min at 3 bar

Ref. no.	Colour	Water connection	Capacity			€
221875	green	G 1/2"	2,8 L	1	60	
221876	green	G 3/4"	2,8 L	1	60	

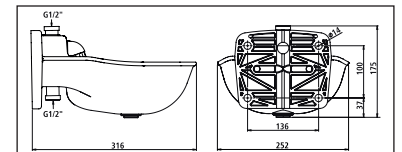

Ref. no.	Description	Colour	Material	Connection	suitable for	Frame height		€
222019	Pipe Mounting Brackets, in pairs		metal, powder-coated				1	
221971	Guard Size 2		hot-dip galvanised metal			20 cm	1/4	
221886	Valve						1/20	
222018	Regulating screw		Nylon				1/200	
2220405	Outlet seal		Plastic				1/30/450/720	
22209	Sealing plug	black	Plastic	1/2"	221500, 221800, 222000, 222500, 222005, 222010		1/200/1000	
2218606	Sealing plug	black	Plastic	3/4"			1/200	

Drinking Bowls K71

- high-quality drinking bowl made of durable plastic • deep bowl for sufficient water supply of dairy and beef cattle • specially integrated brass pipe connector ensures a safe connection to the water pipe • smooth and retractable nose paddle allows optimum water intake • extremely stable mounting on wall or tube with metal reinforcing • with valve no. 223437 also suitable for connection to low pressure • 4 elongated holes for variable fastening • lockable paddle

lockable paddle



Technical data	
221871	
Dimensions (W x D x H)	22,6 cm x 30,5 cm x 16,5 cm
Connection option	from above or below
Water flow rate	3-way adjustable
Flow rate	7,5 - 11 l/min (3 bar)
Flow rate	11 L/min at 3 bar

Ref. no.	Colour	Water connection	Capacity			€
221871	green	G 1/2"	2,4 L	1	72	

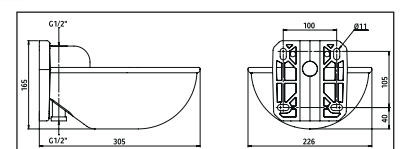

Ref. no.	Description	Material	Connection	Frame height		€
223426	Valve high-pressure	brass			1/20/200	
223437	Valve low-pressure	Plastic			1/100/400	
22501	tube mounting bracket with stabilising plates in pairs	metal			1/25	
221970	Guard Size 1	hot-dip galvanised metal		20 cm	1/4	
22209	Sealing plug	Plastic	1/2"		1/200/1000	

Guard

- made from solid, galvanised steel pipe



221970



221971

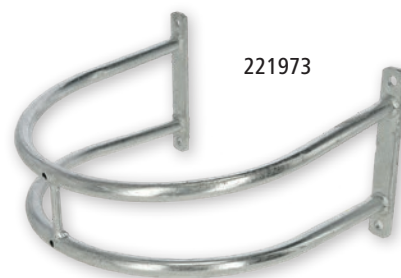

221973

221970: Size 1 suitable for water bowl 221971: Size 2 suitable for water bowl 221973: Size 3 suitable for water bowl

22360, 22375, 22378, 22465, 22466, 22500, 22504, 221000, 221851, 221500, 221600, 221853, 221870, 221871, 221874, 222000, 222005, 222010, 222020, 222030, 222500, 222709 221860, 2218605, 221875, 221876, 222040, 222045, 222050, 222055, 22445, 22355, 225030, 225031, 225032, 225033, 225035, 222070, 222062, 222063, 222064, 222065, 22195 222070, 222062, 222063, 222064, 222065, 22195

Ref. no.	Description	Material	Width	Depth	Height incl. installation plates			€
221970	Size 1	hot-dip galvanised metal	24 cm	30 cm	20 cm	1/4	60	
221971	Size 2	hot-dip galvanised metal	29 cm	34 cm	20 cm	1/4	48	
221973	Size 3	hot-dip galvanised metal	41 cm	36,3 cm	22 cm	1/4	32	

Drinking Bowls KN50

for low pressure

- water bowl made from high-quality plastic
- with low-pressure valve
- lockable tongue (separate accessory)
- fastening clip and stabilisation plate are not included in the scope of delivery
- for wall and pipe mounting

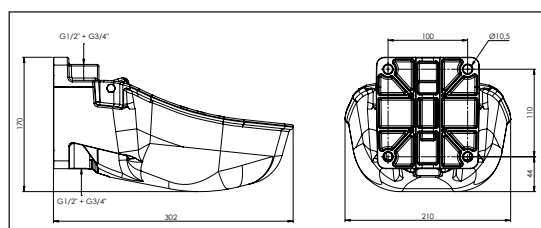

Technical data	225035
Dimensions (W x D x H)	21 cm x 30,2 cm x 17 cm
Connection option	from above or below
Flow rate	7,2 L/min at 0,5 bar, 10,8 L/min at 0,75 bar
Weight	0,95 kg



22501

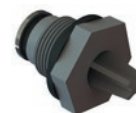

223437



Ref. no.	Colour	Water connection	Capacity			€
225035	green	G 1/2" / G 3/4"	2,2 L	1	120	

Ref. no.	Description	Colour	Material	Connection	Frame height		€
221757	Adapter Plate for Pasture Barrel Attachment		metal			1/5	
2218606	Sealing plug	black	Plastic	3/4"		1/200	
221971	Guard Size 2		hot-dip galvanised metal		20 cm	1/4	
223437	Valve low-pressure		Plastic			1/100/400	
22501	tube mounting bracket with stabilising plates in pairs		metal			1/25	
225034	Nose Paddle		Plastic			1/40	

Drinking Bowls K50

- water bowl made from high-quality plastic
- lockable tongue (separate accessory)
- 4-hole fastening
- suitable for 1/2" and 3/4" connections
- Fastening material not included
- for wall and pipe mounting

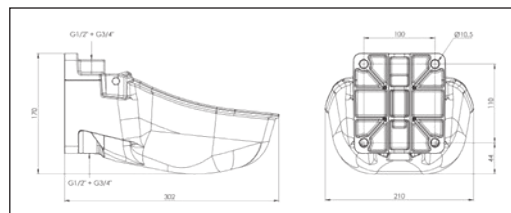

225030



225032



225033



225031



suitable for 1/2" and 3/4" connections

Technical data

Dimensions (W x D x H)	21 cm x 30,2 cm x 17 cm
Connection option	from above or below
Water flow rate	3-way adjustable
Flow rate	7,5 - 11 l/min (3 bar)
Weight	950 g



Ref. no.	Description	Colour	Water connection	Capacity	MOQ	Pieces / unit			€
225031	Kerbl design	green	G 1/2" / G 3/4"	2,2 L		1	120		
225032	Kerbl design	olive green	G 1/2" / G 3/4"	2,2 L		1	120		
225030	neutral presentation	blue	G 1/2" / G 3/4"	2,2 L		1	120		
225033	neutral presentation	black	G 1/2" / G 3/4"	2,2 L	2 pieces	2 / box	1/2	160	

Ref. no.	Description	Colour	Material	Connection	Frame height		€
2218606	Sealing plug	black	Plastic	3/4"		1/200	
221971	Guard Size 2		hot-dip galvanised metal		20 cm	1/4	
223426	Valve high-pressure		brass			1/20/200	
22501	tube mounting bracket with stabilising plates in pairs		metal			1/25	
225034	Nose Paddle		Plastic			1/40	
2250341	Panel Lock for Drinking Trough K50					1/50/500	

Water trough

- sturdy special material, extremely break-resistant and keeps its shape • UV and frost resistant • carefully thought-out design • stable internal wall curving inwards • oval shape allows easy loading into a small transporter • large outlet for rapid drainage (outlet item no. 16601 included) • water connection and float valve protected from animals • easy cleaning thanks to smooth surfaces and rounded edges - no inaccessible areas • stackable • Floor anchoring optionally available (accessories not included in the scope of delivery) • suitable for float valve 220P (41 l/min at 3 bar) and XtraFlo (250 l/min at 3 bar) • Float valve not included!



Extra-reinforced inner rim and optimised float position for better water level regulation

Ref. no.	Colour	Capacity	Length	Width	Height			€	
223623	green	550 L	150 cm	115 cm	62 cm	1	6		
223624	green	1000 L	235 cm	125 cm	61 cm	1	6		

Ref. no.	Description	Material		€
223440	Floating valve XtraFlo Top Entry		1/10/20	
223441	Floating valve 220P		1	
16601	Outlet for Footbath / Water Trough	Plastic	1/100	
223629	Ground anchor		1/10	



Drinking trough with float valve

- sturdy drinking trough made from plastic resistant to impact and biting • with efficient float valve • Capacity adjustable from 5 to 8 litres • Valve cover made from rust-resistant stainless steel • Outlet with plug for easy cleaning • with 4 mounting holes • especially suitable for cattle and horses • with drain plug • Material: Plastic

Technical data	22172
Dimensions (W x D x H)	33 cm x 28 cm x 33,5 cm
Connection option	from left or right
Flow rate	6 L/min at 3 bar



22192

Ref. no.	Colour	Water connection	Capacity			€
22172	green	G 1/2"	9 L	1	40	

Ref. no.	Description		€
22192	Floating valve High pressure	1/50	



Float Bowl S522

- low-priced float bowl made of polypropylene • with outlet plug for easy cleaning

Technical data	22522
Dimensions (W x D x H)	25,5 cm x 29 cm x 14,5 cm
Connection option	from left or right
Flow rate	6,5 L/min at 3 bar

Made in Italy



Ref. no.	Colour	Water connection	Capacity			€
22522	green	G 1/2"	3 L	1/9	189	



Ref. no.	Description	Material	Frame height		€
22523	Floating valve			1/100	
22524	Drain Plug			1/1500	
221971	Guard Size 2	hot-dip galvanised metal	20 cm	1/4	



22523

Float Bowl S30

- water bowl made from high-quality plastic • with valve type 22182 also suitable for connection to low pressure • valve cover with snap hook for rapid access • suitable for high and low pressure • for wall and pipe mounting • with drain plug

Technical data	222070
Dimensions (W x D x H)	29,4 cm x 34 cm x 16,1 cm
Connection option	from left or right
Flow rate	6,5 L/min at 3 bar
Weight	2,3 kg



Also available as a heated version (item no. 222062 - 222065)



Top Quality

Ref. no.	Colour	Water connection	Capacity			€
222070	green	G 1/2"	5 L	1	42	

Ref. no.	Description	Material	Frame height		€
222019	Pipe Mounting Brackets, in pairs	metal, powder-coated		1	
22192	Floating valve High pressure			1/50	
22182	Floating valve Low pressure			1/100	
221973	Guard Size 3	hot-dip galvanised metal	22 cm	1/4	
2220405	Outlet seal	Plastic		1/30/450/720	



223518

Water trough

- stackable
- stable and inexpensive water troughs for outdoor use
- with edge for optimal stability
- a Suspended Float Valve 222905 can be retrofitted
- lightweight and simple to set up
- Material: plastic, UV-stabilised

223517



Ref. no.	Description	Colour	Length	Width	Height	Capacity			€
223518	without drain plug	dark green	102 cm	72 cm	38 cm	150 L	1	45	
223517	with drain plug	dark green	130 cm	81 cm	63 cm	380 L	1	35	

Ref. no.	Description	Material		€
222905	Immersion Float Valve	stainless steel	1/50	
16601	Outlet for Footbath / Water Trough	Plastic	1/100	



Immersion Float Valve

- can be hung on the edge of troughs, basins and vats • automatically keeps the level upright
- easy to install anywhere • High pressure and low pressure nozzle included • Plastic float valve, stainless steel case • Stainless steel hanging hooks for the bowl edge can be released without tools • Low pressure nozzle (white) up to 4.5 L/min flow rate at 0.5 bar • High pressure nozzle (black) up to 4.5 L/min flow rate at 3 bar • Material: stainless steel

Ref. no.	Water connection		€
222905	1/2"	1/50	



Water bowl for pasture barrel attachment

- drinking trough made of corrosion-free cast aluminium • suitable for all water containers
- complete with gasket (221753) • complete with low pressure valve

Ref. no.	Water connection	Capacity			€
22175	Flange	2,6 L	1	90	

Technical data	22175
Dimensions (W x D x H)	23,5 cm x 28,7 cm
Flow rate	10 L/min at 0,2 bar

Ref. no.	Description		€
221753	Box Seal 8-edged	1/100	
22176	Valve low-pressure	1/50/500	



Pasture Pump



with double-acting function

- extremely smooth pasture pump thanks to aluminium lever and pivot points carried in plain bearings
- sturdy cast iron drinking cup
- modern design
- fresh clean water available all the time
- Minimum maintenance
- pumps the water from a depth of 8 m
- 0.6 litres per stroke (depending on the suction depth)
- suitable for pipe and hose connection
- hose and strainer available as accessories (not included in scope of delivery)
- suitable for cattle and horses
- Hole spacing for mounting holes: 425 x 260 mm

P100 Duo (221135): additional specially adapted drinking bowl for the calf

- ideal for cow-bonded calf rearing
- Mother cow and calf can drink at the same time
- The mother cow also pumps water for the calf. The water flows from the main basin into the small water container for the calf



Ref. no.	Description	Water connection			€
221100	P100	3/4"	1	12	
221120	P100	1"	1	12	
221135	P100 Duo	1"	1	12	

Ref. no.	Description		€
221102	Membrane	1/50	

Suction Hose Set for Pasture Pump

- suitable for 3/4" and 1" pasture pumps

Set consisting of: 1 x 7 m suction hose 1", 1 x 1" suction cage, 2 x hose clamp, 2 x 1" hose connector (1" OT - 1" suction hose), 1 x coupling (3/4" IT - 1" IT), 1 x coupling (1" IT - 1" IT)



Ref. no.	Length		€
221123	7 m	1	

Ref. no.	Description	Material	Length	Ø	Tube inner diameter		€
221119	Suction Hose with rigid PVC spiral	PVC	25 m	30 mm	25 mm	1	
221122	Suction Cage with Hose Connection					1/50	

Float Set for Pasture Pump

- suitable for 3/4" and 1" pasture pumps
- Float ball prevents the suction cage sinking to the water bed and thus the suction of turbid water and sludge
- Suction cage floats approx. 15 cm under the water surface

Ref. no.		€	Set consisting of: 1 x float ball (Ø 145 mm) with eyelets, 1 x 1" suction cage including 1" hose connection
221121	1/20		



Connector Set for Pasture Pump

- suitable for 3/4" and 1" pasture pumps

Set consisting of: 1 x hose clamp, 1 x 1" hose connector (1" OT - 1" hose supports), 1 x coupling (3/4" IT - 1" IT), 1 x coupling (1" IT - 1" IT)

Ref. no.		€
221124	1/50	



Water bowl for pasture barrel attachment

KN50

- water bowl made from high-quality plastic
- incl. adapter plate for direct connection to pasture barrels
- complete with low pressure valve
- complete with flange seal
- for attaching to barrels

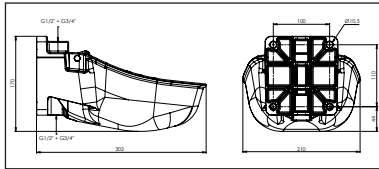

Technical data	221755
Dimensions (W x D x H)	21 cm x 30,2 cm x 17 cm



Ref. no.	Description	Colour	Capacity		€
221755	incl. adapter plate	green	2,2 L	1	
Ref. no.	Description	Material		€	
221757	Adapter Plate for Pasture Barrel Attachment	metal	1/5		
221758	Cardboard Seal for Adapter Plate	Cardboard	1/100		
225034	Nose Paddle	Plastic	1/40		
223437	Valve low-pressure	Plastic	1/100/400		

Connector set for IBC container

- for connecting a drinking bowl to an IBC container
- flexible reinforced hose 70 cm
- incl. connecting accessories (see scope of delivery)



Included in delivery: 1 x reinforced hose 70 cm (2 x 3/4" IT connection), 1 x adapter for IBC container incl. gasket (S60 x 6 on 3/4" OT), 1 x straight reducer 3/4" OT to 1/2" IT, 1 x double nipple 1/2" OT to 1/2" OT, 1 x double nipple 3/4" OT x 3/4" OT



Ref. no.		€
221980	1/20	

Installation Plate for IBC Container

- installation plate for securing drinking bowls to IBC container
- suitable for drinking bowls with low-pressure valve • Material: metal

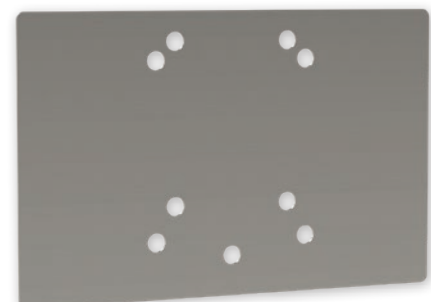

Which water bowls will fit?

Item no. 22215	Float Drinking Bowl SN190
Item no. 225035	Drinking Bowl KN50
Item no. 222030	Drinking Bowl N20

Ref. no.	Length	Width		€
221981	275 mm	175 mm	1/10	



Double Float Drinking Bowl S60

for wall and tube mounting

- water bowl made from high-quality plastic
- for up to 40 large cows
- suitable for high and low pressure
- with inner lip to avoid water waste
- with 2 outlet plugs for easy cleaning
- larger outlet (16601) can be retrofitted
- valve on the top for rapid access to the valve
- with drain plug

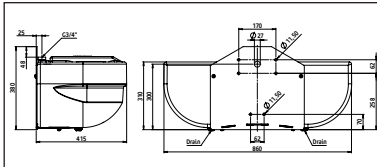

Technical data	223618
Dimensions (W x D x H)	86 cm x 41,5 cm x 38 cm
Connection option	from above, below or behind
Flow rate	54 L/min at 5 bar, 41 L/min at 3 bar, 24 L/min at 1 bar
Weight	15 kg

Ref. no.	Description	Colour	Water connection	Capacity			€
223618	for wall and tube mounting	green	G 3/4"	58 L	1	8	

Ref. no.	Description	Material	Frame height		€
16601	Outlet for Footbath / Water Trough	Plastic		1/100	
221974	Guard for S60	hot-dip galvanised metal	39 cm	1	
223441	Floating valve 220P			1	



Double float drinker for pasture barrel attachment S60

- water bowl made from high-quality plastic
- for up to 40 large cows
- complete assembly for easy mounting to pasture barrel
- with inner lip to avoid water waste
- with 2 outlet plugs for easy cleaning
- larger outlet (16601) can be retrofitted
- valve on the top for rapid access to the valve
- with drain plug

complete assembly for easy mounting to pasture barrel

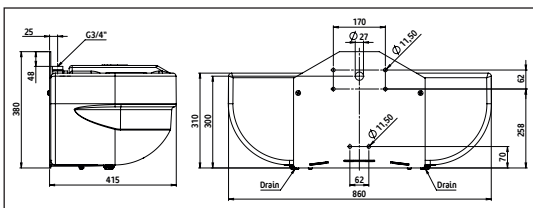

Technical data	223619
Dimensions (W x D x H)	90 cm x 45 cm x 35 cm
Connection option	from above, below or behind
Flow rate	24 L/min at 1 bar
Weight	15 kg



Ref. no.	Description	Colour	Capacity			€
223619	for pasture attachments	green	58 L	1	8	



Ref. no.	Description	Material		€
16601	Outlet for Footbath / Water Trough	Plastic	1/100	
223441	Floating valve 220P		1	



Frost-Protection Drinking Bowls



Water Bowl Heatable H10

- drinking bowl made of gray cast iron, black enamelled
- Grey cast iron bottom tray, black power-coated finish
- water flow rate can be regulated on the pipe valve
- new heating concept with valve heating to keep clear of frost
- easy to install bowl, no need to remove the valve for installation
- power supply via transformer at least 100 W (not supplied)
- suitable for circulating heating systems
- simple electrical connection through the terminal box on the outside
- for wall and pipe mounting

frost-protected down to approx. -20 °C



Upper shell
Heating element
Lower shell



24 V pin can be connected to the 24 V conduit without disassembling the drinking bowl



80 W or 50 W

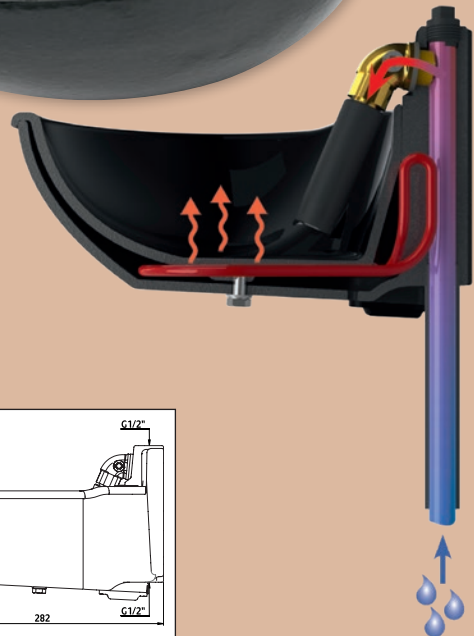
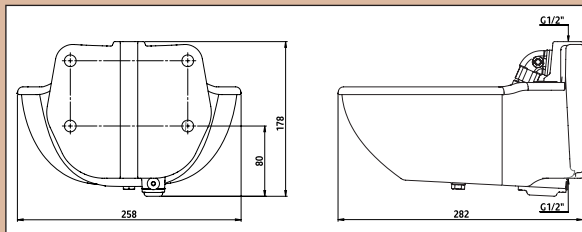

Technical data

Dimensions (W x D x H)	25,8 cm x 28,2 cm x 17,8 cm
Connection option	from above or below
Flow rate	8 L/min at 3 bar
Weight	11,5 kg

Ref. no.	Colour	Heating output	Voltage	Water connection	Capacity			€
222010	black	80 W	24 V	G 1/2"	1,6 L	1	48	
222005	black	50 W	24 V	G 1/2"	1,6 L	1	48	

Ref. no.	Description	Material	Length	Width	Height	Connection	Frame height		€
222019	Pipe Mounting Brackets, in pairs	metal, powder-coated						1	
221971	Guard Size 2	hot-dip galvanised metal					20 cm	1/4	
221975	Protection against chewing for pipelines	steel plate, galvanic zinc-plated	100 cm	13,2 cm	8 cm			1	
221886	Valve							1/20	
222018	Regulating screw	Nylon						1/200	
22209	Sealing plug	Plastic				1/2"		1/200/1000	

Frost-Protection Drinking Bowls

Water Bowl Heatable HP20

• drinking bowl made from high-quality plastic (PP) with integrated heating cable • heating cable easy to replace • integrated frost protection thermostat (switch-on temperature approx. +3 °C, switch-off temperature approx. +13 °C) • controllable water flow rate (up to 11 litres/minute) • suitable for circulating heating systems • with outlet plug for easy cleaning • for wall and pipe mounting

- 222040 and 222045: Heating cable (approx. 31 W) for heating the drinking bowl and valve
- 222050 and 222055: Heating cable (approx. 73 W) for heating the drinking bowl, valve and up to 2 metres of pipeline (auxiliary pipe heating)
- a transformer is required for the 24 V version (not included)



frost-protected down to approx. -25 °C

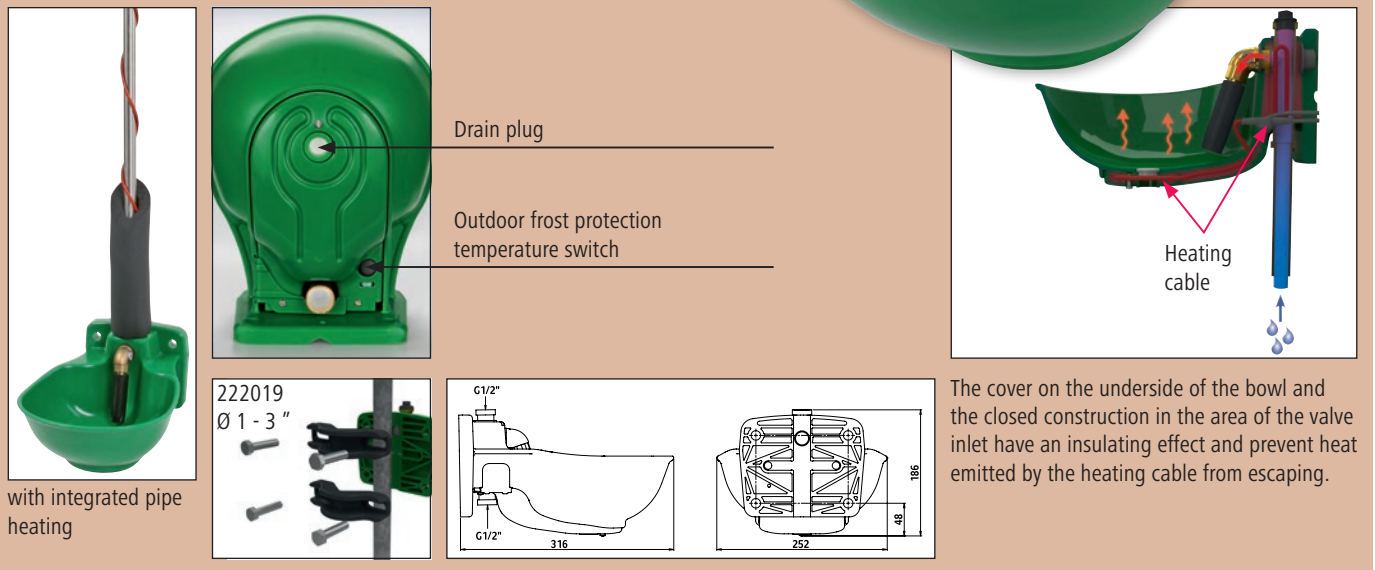

with integrated pipe heating

Drain plug

Outdoor frost protection temperature switch

Heating cable

The cover on the underside of the bowl and the closed construction in the area of the valve inlet have an insulating effect and prevent heat emitted by the heating cable from escaping.

4 variants	with auxiliary pipe heating, 73 W	without auxiliary pipe heating, 31 W
24 V	222055	222045
230 V	222050	222040

Technical data	
Dimensions (W x D x H)	252 mm x 316 mm x 186 mm
Connection option	from above or below
Flow rate	10 L/min at 3 bar
Weight	2 kg

Ref. no.	Colour	Pipe Heating	Heating output	Voltage	Water connection	Capacity			€
222040	green	without pipe heating	31 W	230 V	G 1/2"	2,8 L	1	60	
222050	green	with auxiliary pipe heating	73 W	230 V	G 1/2"	2,8 L	1	60	
222045	green	without pipe heating	31 W	24 V	G 1/2"	2,8 L	1	60	
222055	green	with auxiliary pipe heating	73 W	24 V	G 1/2"	2,8 L	1	60	

Ref. no.	Description	Material	Length	Width	Height	Connection	suitable for	Frame height		€
222019	Pipe Mounting Brackets, in pairs	metal, powder-coated							1	
221971	Guard Size 2	hot-dip galvanised metal						20 cm	1/4	
221975	Protection against chewing for pipelines	steel plate, galvanic zinc-plated	100 cm	13,2 cm	8 cm				1	
221886	Valve								1/20	
222018	Regulating screw	Nylon							1/200	
2220405	Outlet seal	Plastic							1/30/450/720	
22209	Sealing plug	Plastic				1/2"	221500, 221800, 222000, 222500, 222005, 222010		1/200/1000	

Frost-Protection Drinking Bowls

Float Water Bowl Heatable SH30



- drinking bowl made from high-quality plastic with integrated heating cable
- integrated frost protection thermostat (switch-on temperature approx. +3 °C, switch-off temperature approx. +13 °C)
- heating cable easy to replace
- suitable for circulating heating systems
- valve cover with snap hook for rapid access
- with valve type 22182 also suitable for connection to low pressure
- with outlet plug for easy cleaning
- for wall and pipe mounting

- 222062 + 222063: with heating cable (approx. 31 W) for heating the drinking bowl and valve
- 222064 + 222065: with heating cable (approx. 73 W) for heating the drinking bowl, valve and up to 2 metres of pipeline (auxiliary pipe heating)
- a transformer is required for the 24 volt version (not included)



frost-protected down to approx. -15 °C

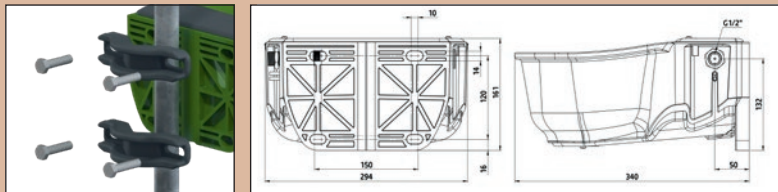

Drain plug

Outdoor frost protection temperature switch

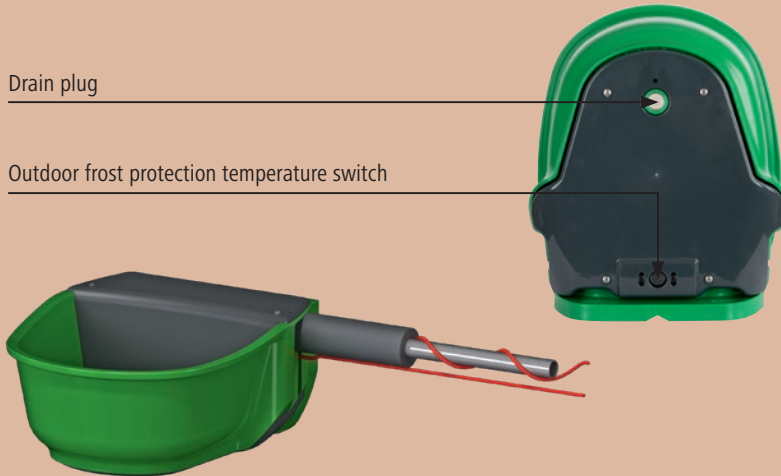

The cover on the underside of the bowl prevents the heat given off by the heating cable from escaping.

4 variants	with auxiliary pipe heating, 73 W	without auxiliary pipe heating, 31 W
24 V	222065	222063
230 V	222064	222062

Technical data	
Dimensions (W x D x H)	295 mm x 340 mm x 161 cm
Connection option	from left or right
Flow rate	6 L/min at 3 bar
Weight	2,7 kg

Ref. no.	Colour	Pipe Heating	Heating output	Voltage	Water connection	Capacity			€
222062	green	without pipe heating	31 W	230 V	G 1/2"	5 L	1	42	
222063	green	without pipe heating	31 W	24 V	G 1/2"	5 L	1	42	
222064	green	with auxiliary pipe heating	73 W	230 V	G 1/2"	5 L	1	42	
222065	green	with auxiliary pipe heating	73 W	24 V	G 1/2"	5 L	1	42	

Ref. no.	Description	Material	Frame height		€
222019	Pipe Mounting Brackets, in pairs	metal, powder-coated		1	
22192	Floating valve High pressure			1/50	
22182	Floating valve Low pressure			1/100	
221973	Guard Size 3	hot-dip galvanised metal	22 cm	1/4	
2220405	Outlet seal	Plastic		1/30/450/720	



Transformer for trough heating

- transforms the voltage from 230 volts to 24 volts
- can be used for all frost-free waterers
- Short circuit and overload protection through easily replaceable automotive fuse in the output circuit
- the transformers are also secured against overheating thanks to an integrated temperature limiter (automatic reset after cool-down)
- IP 65 (transformer) / IP 20 (connection)
- Produced using vacuum casting: the best possible protection against moisture, mechanical and electronic loads



Ref. no.	Thickness		€
222796	100 VA	1/68	
222797	200 VA	1	
222626	300 VA	1/50	
222798	400 VA	1	



Conventional car microfuses for safe operation of the installation

Which transformer should be used?

If you want to operate a water bowl with 80 watts of power (supplied), then a 100-watt transformer will suffice (item no. 222796). If you also want to connect a 24 V heating cable, simply add the current consumption (= wattage) of the cable. When selecting the transformer, plan for a power reserve of 15 % (factor 1.15).

Calculation example for transformer:

2 x Drinking Bowls with 100 W Power Consumption	= 200 watts
1 x frost-protection heating line 24 V each with 30 W	= 30 watts
1 x frost-protection heating line 24 V each with 15 W	= 15 watts
total consumer power	= 245 watts
Buffer (flat rate of 15 %) 245 W x 1.15	= 282 watts

The transformer of choice has an output of 300 W.

Which cable should I use?

If the 24 V supply has to cover a larger distance between the transformer and the heater, please pay attention to the cable cross-section, to prevent the risk of drops in voltages along the cable's route.

Calculation to ascertain the minimum cable cross-section: **Power x cable length: 3200 W/m**

In the above example, the result for a distance of 25 metres from the transformer to the heater is as follows: $(282 \text{ W} \times 25 \text{ m} : 3200 \text{ W/m}) \text{ mm}^2 = 2.2 \text{ mm}^2$

In this case, a cable with a cross-section of 2.5 mm² must be used.

Frost protection heating pipe with thermostat



• keeps your water line frost-free to -45 °C • integrated frost protection thermostat (switch-on temperature approx. +3 °C, switch-off temperature approx. +13 °C) • not suitable for heating pipes • do not insulate the thermostat when adding insulation • Protect the area animals could chew on with a bite protector • Mechanical strength class M1 (not suitable for gutters or other applications with mechanical load) • VDE-approved heating pipe (except 49 m heating pipe) • 230 V • Connection cable length: 2 m • Voltage: 230 V • VDE tested • IPX7



Do not mount in animal feed area unprotected - use only 24-volt heating cable. Do not shorten the heating cable!



frost-protected down to max. -45 °C

Ref. no.	Heating output	Heating cable length	Plug type			€
223582	16 W	1 m	Safety Plug E + F	1/16	320	
223585	32 W	2 m	Safety Plug E + F	1/16	320	
223586	64 W	4 m	Safety Plug E + F	1/16	320	
223587	128 W	8 m	Safety Plug E + F	1/16	320	
223588	192 W	12 m	Safety Plug E + F	1/16	192	
223590	224 W	14 m	Safety Plug E + F	1/16	192	
223589	288 W	18 m	Safety Plug E + F	1/10	120	
223591	384 W	24 m	Safety Plug E + F	1/10	120	
223592	592 W	37 m	Safety Plug E + F	1/5	75	
223593	784 W	49 m	Safety Plug E + F	1/5	60	

Frost-protection heating lines

- prevent water pipes from freezing
- thermostat in the heating cable switches the cable on automatically

What to remember about 230 V heating cables:

- installation must be carried out by a qualified professional in accordance with VDE0100
- always attach the heating cable to the underside of the pipe
- the water pipe must be earthed
- 230 V heating cables are ready to connect and should be connected to a power supply with a 30 mA residual current circuit breaker
- the heating cables must not be shortened
- the heating cable must not be 600 mm shorter or longer than the pipe section to be heated
- excess length can be wound around the end of the pipe (note that a winding distance of at least 50 mm must be maintained between coils)
- do not bend heating cables and note the maximum bending radius of approx. 20 mm
- heating cables can be secured to the pipe with insulating tape or aluminium tape (222809)
- the heating cable must only be used on plastic resistant water lines approved for hot water that are always filled with water
- if using plastic pipes, wrap aluminium tape (222809) around the pipe before routing the heating cable
- if using plastic pipes, please pay attention to the separate, specific assembly instructions
- insulate the pipeline and heating cable with non-flammable insulation of max. 13 mm
- attach the heating cable thermostat to the coldest part of the pipe
- do not use 230 V heating cables in the bite area of animals

Pipe	Ø 15 mm	Ø 22 mm 1/2"	Ø 28 mm 3/4"	Ø 35 mm 1"	Ø 42 mm 1 1/4"	Ø 48 mm 1 1/2"	Ø 60 mm 2"	Ø 76 mm 2 1/2"
with insulation (max. 13 mm) frost-resistant to	- 45 °C	- 45 °C	- 40 °C	- 40 °C	- 35 °C	- 30 °C	- 25 °C	- 20 °C

Frost Protection Thermostat

- suitable for all bowl and tube heating systems
- External probe ensures automatic switching on and off
- in the splash-proof housing
- max. permitted power 3.6 kW
- Protection class: IP54

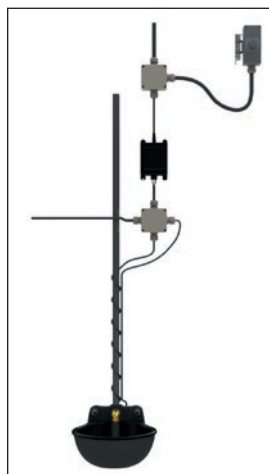



The frost protection thermostat should be installed at the coldest point.

Ref. no.		€
222794	1/30	

Extension for Heated Rod

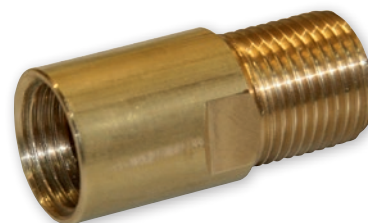
- Extension of 30 mm
- suitable for heating rods 221760 and 221761
- required for drinkers 22500, 22504 and 221871
- also recommended when using the heaters in all other drinkers made by other manufacturers
- Material: brass





Ref. no.	Thread		€
221765	1/2" IG / 1/2" AG	1/150	

Frost protection heating pipe 24 V

- for heating the spur line of waterers
- a 24 V transformer is required for operation
- Voltage: 24 V
- IPX7



Ref. no.	Heating output	Heating cable length			€
22358	15 W	1,5 m	1/60	720	
223581	30 W	3 m	1/40	720	

Aluminium Adhesive Tape

- Aluminium vapour-coated PP foil, combined with a special acrylate-based bonding adhesive
- for heat reflection on water pipes
- around 25 m aluminium adhesive tape is required for a 3.5 m long 3/4" pipe

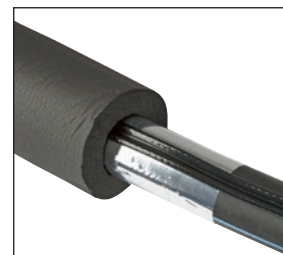
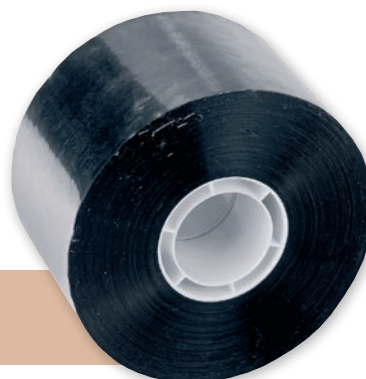

Tip: You always need aluminium adhesive tape for plastic pipes, otherwise there will be no heat conduction

Ref. no.	Length	Width		€
222809	100 m	50 mm	1/54	

Wrap the plastic water lines from the heating cable assembly with aluminium adhesive tape

Circulation Pump C10

circulation pump with integrated heating element for year-round operation

The ideal solution for supplying animals with water at a pleasant temperature. The constant movement of the water and the switchable heating provide double anti-freezing protection.

- 3-step switch: 0 = Off, 1 = Circulation mode, 2 = Circulation and heating mode
- automatic control of the set water temperature
- automatic safety shut-off in case of overheating
- the LED on the control box indicated whether the heater is turned on and heating
- air vent valve on the radiator
- circulation pump with three different speeds
- easy installation by an authorised expert
- low space requirement due to compact design
- very easy to maintain
- components can be quickly disconnected and disassembled
- for drinking systems with a loop length of max. 250 m (and a pipe diameter of 3/4")
- Stainless steel housing
- flow indicator and thermometer available as optional accessories
- Water connection: 1" (inlet and outlet)
- Voltage: 230 V



Made in Germany



Included in delivery: 1 x circulation pump, 1 x flow tube with integrated heating element, 1 x non-return valve, 1 x air vent, 1 x overpressure valve, 1 x pump screw connector G 1 1/2" - Rp. 1" for circulation pump

Ref. no.	Length	Width	Height	pump capacity	Heating output			€
223130	52 cm	41,5 cm	26,5 cm	50 W	3.000 W	1	12	

Ref. no.	Description		€
223131	Flow Indicator with Float - connection thread DN25 G1"	1	
223132	thermometer connection with thermometer - connection size DN25	1	

Further information on the circulation pump as well as interesting facts on the subject of water bowls can be found in our brochure Drinking Technology for Stables and Pastures.

Pasture Gates and Fence Panels

Pasture Gate adjustable

- stable galvanised steel pasture gate

Included in delivery: 1 x pasture gate, 2 x hinges, 1 x locking facility, 6 x wood screws (12 x 80 mm)



The hinge installation set can be compensated by adjusting the threaded hinge bolts.

Can be extended with an adjustable set screw

Closing option available (without lock)
• optional padlock for locking

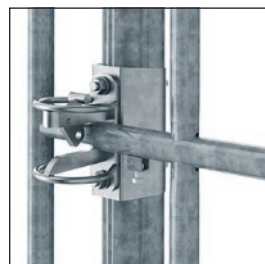
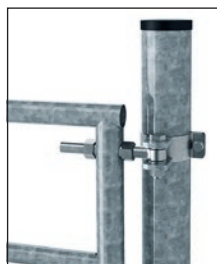

The hinge installation set can be compensated by adjusting the threaded hinge bolts.

Closing option available (without lock)

Ref. no.	Description	Adjustability	Height	Material			€
44893	Pasture Gate adjustable	1 - 1,7 m	110 cm	steel, hot-dip galvanised	1		
44892	Pasture Gate adjustable	2 - 3 m	110 cm	steel, hot-dip galvanised	1		
44891	Pasture Gate adjustable	3 - 4 m	110 cm	steel, hot-dip galvanised	1		
44895	Pasture Gate adjustable	4 - 5 m	110 cm	steel, hot-dip galvanised	1		
442557	Pasture Gate adjustable	5 - 6 m	110 cm	steel, hot-dip galvanised	1	23	

Ref. no.	Description	Material	Length	Ø		€
442577	Gate Post for Pasture Gate with plastic cap	hot-dip galvanised metal	2 m	88 mm	1	
442578	Lock Catch for Gate Post	hot-dip galvanised metal			1	
442579	Hinge pin bracket (in pairs) for gate post	hot-dip galvanised metal			1	
442940	Locking Bar for Pasture Gate	hot-dip galvanised metal			1	

Please note separate freight costs.



Pasture gate adjustable for horse owners

Robust and durable safety for your horses at gates and passageways.



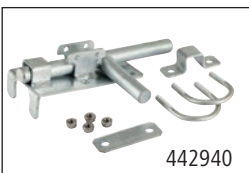
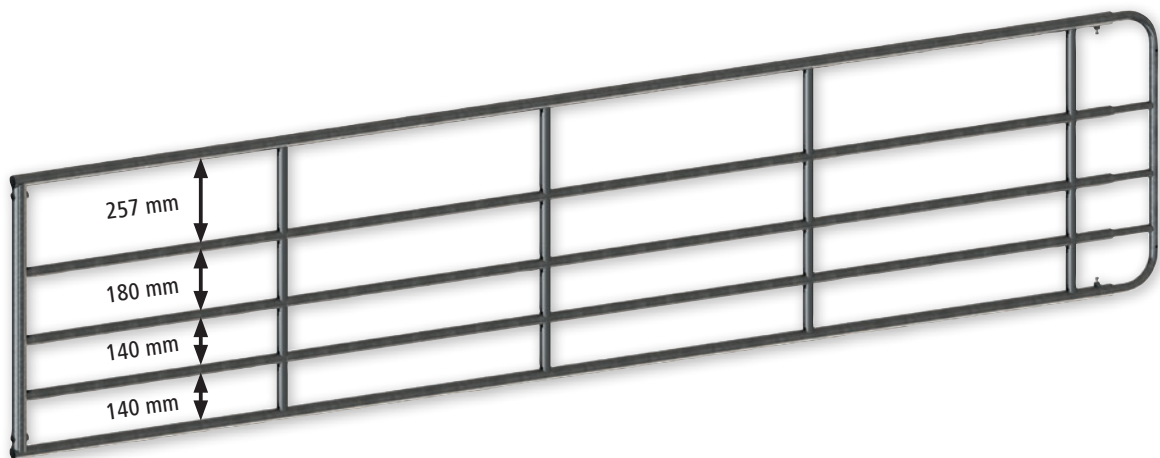



- especially robust design that complies with the relevant horse care directives with its product dimensions
- clear widths between the tubes are configured in such a way that horses cannot become dangerously trapped in the gate and then no longer be able to free themselves
- thanks to the protective distance bar supplied, horses cannot get into the dangerously narrow space between the gate and suspension or jump up and injure themselves
- stable, hot-dip galvanised steel pasture gate





442940

Included in delivery: 1 x pasture gate, 1 x distance protection bar, 2 x hinges, 1 x locking facility, 6 x wood screws (12 x 80 mm)

Complies with the applicable directives for horse husbandry

Ref. no.	Description	Adjustability	Height	Material			€	
442900	Pasture Gate adjustable	2 - 3 m	90 cm	steel, hot-dip galvanised	1	50		
442901	Pasture Gate adjustable	3 - 4 m	90 cm	steel, hot-dip galvanised	1	23		
442902	Pasture Gate adjustable	4 - 5 m	90 cm	steel, hot-dip galvanised	1	23		

Ref. no.	Description	Material	Length	Ø		€	
442577	Gate Post for Pasture Gate with plastic cap	hot-dip galvanised metal	2 m	88 mm	1		
442578	Lock Catch for Gate Post	hot-dip galvanised metal			1		
442579	Hinge pin bracket (in pairs) for gate post	hot-dip galvanised metal			1		
442940	Locking Bar for Pasture Gate	hot-dip galvanised metal			1		

Pasture Gates and Fence Panels

Pasture gate adjustable for horse owners

Robust and durable safety for your horses at gates and passageways.

- especially robust design that complies with the relevant horse care directives with its product dimensions
- clear widths between the tubes are configured in such a way that horses cannot become dangerously trapped in the gate and then no longer be able to free themselves
- thanks to the protective distance bar supplied, horses cannot get into the dangerously narrow space between the gate and suspension or jump up and injure themselves
- stable, hot-dip galvanised steel pasture gate

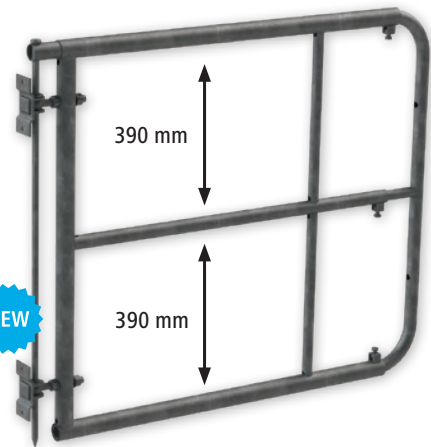



New product NEW

Included in delivery: 1 x pasture gate, 1 x distance protection bar, 2 x hinges, 1 x locking facility, 6 x wood screws (12 x 80 mm)

Complies with the applicable directives for horse husbandry

available from: March 2025





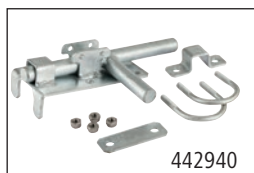
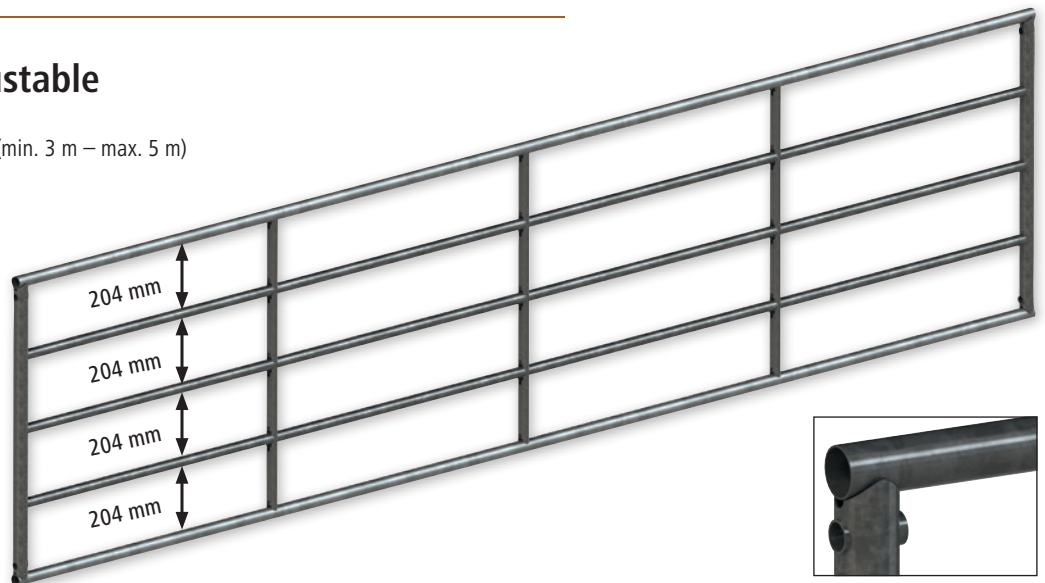

Ref. no.	Description	Adjustability	Height	Material			€
442910	Pasture gate adjustable for horse owners	1 - 1,7 m	90 cm	steel, hot-dip galvanised	1	40	

Pasture Gate not adjustable

- stable galvanised steel pasture gate
- 4 different models with fixed widths (min. 3 m – max. 5 m)

Included in delivery: 1 x pasture gate, 2 x hinges, 1 x locking facility, 6 x wood screws (12 x 80 mm)



Ref. no.	Description	Length	Height	Material			€
442920	Pasture Gate not adjustable	3 m	1 m	steel, hot-dip galvanised	1	23	
442921	Pasture Gate not adjustable	3,5 m	1 m	steel, hot-dip galvanised	1	23	
442922	Pasture Gate not adjustable	4 m	1 m	steel, hot-dip galvanised	1	23	
442924	Pasture Gate not adjustable	5 m	1 m	steel, hot-dip galvanised	1	23	

Ref. no.	Description	Material		€
442940	Locking Bar for Pasture Gate	hot-dip galvanised metal	1	

Please note separate freight costs.

Locking Spike for Pasture Gates

- enables open pasture gates to be fixed in any position
- ideal when setting up double-leaf pasture gates to lock the other half of the gate when one leaf is opened - recommended accessory: Cover for Pasture Gate (442571)
- suitable for all rigid and extendable pasture gates
- very simple and quick assembly, all screws and brackets are included
- height can be flexibly adjusted by means of slotted holes, so that pasture gates with larger floor distances can also be fixed in place
- Material: hot-dip galvanised metal

Ref. no.		€
442572	1	



Pasture Gates and Fence Panels

Mounting Set for Pasture Gates

- for easy mounting of your pasture gate to the post • Material: Hot galvanised metal

Set consisting of: 2 x hinges, 1 x closure option (442558), 6 x wood screws

hot-dip galvanised



Ref. no.		€
44890	1	

Closing Option for Pasture Gate Mounting Set

- enables you to lock your pasture gate via the brass padlock
- Padlock not included
- Material: hot-dip galvanised metal



Ref. no.		€
442558	1	

hot-dip galvanised

Swing-Through Lock for Fence Gates

- the swing-through lock allows the gate to be opened in both directions
- the lock is fitted to the post and gate using the screws supplied
- can be used on all fence gates
- Material: metal



Ref. no.	Colour		€
441025	black	1/6	

Stabiliser for Adjustable Pasture Gates

- Solid Rubber Wheel Ø 200 mm
- all steel parts are hot dip galvanised
- can be height-adjusted



Ref. no.		€
442559	1	

Electrics Kit for Fence Gates

- kit for additional electrification of your fencing system around fence gates
- fence gate can continue to be opened by hand

441224 Set consisting of: 6 x ring clamp, 6 x ring insulator with short support and metric thread, 1 x rope/tape coupling, 14 m rope Ø 6 mm (Top Line Plus)



Ref. no.	Description	Pieces / unit		€
441224	Set of 6	1 / pack	1/16	

Cover for Pasture Gates

- enables the assembly or safe connection of double-leaf gates
- secure locking mechanism with latching function, optionally lockable with padlock (not included)
- suitable for all rigid and extendable pasture gates
- Material: hot-dip galvanised metal

Recommended accessories: Locking Spike for Pasture Gates (442572)



Ref. no.		€
442571	1	

Pasture Gates and Fence Panels



Pasture Panel

- perfect for erecting mobile and flexible fencing as well as temporary horse boxes
- also commonly used to fence off riding and training areas
- also suitable for constructing trap systems and gangways
- height of upper tube 1.6 m
- safety mounting bracket prevents animals from being injured. When landing on the panel, the animal does not fall between two panels if it slips
- made from flat oval pipe 50 x 30 mm
- clear distance between tubes 20 cm
- rapid chain fastening makes it quicker and easier to connect several panels
- very stable at light loads
- curved feet ensure excellent stability



Rapid chain fastening, hot-dip galvanised









Safety mounting bracket



curved feet ensure excellent stability



Ref. no.	Description	Material	Length	Height			€	
442591	Pasture Panel without gate	steel, hot-dip galvanised	240 cm	170 cm	1	35		
442592	Pasture Panel without gate	steel, hot-dip galvanised	300 cm	170 cm	1	36		
442593	Pasture Panel without gate	steel, hot-dip galvanised	360 cm	170 cm	1	18		

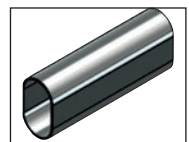

Please note separate freight costs.

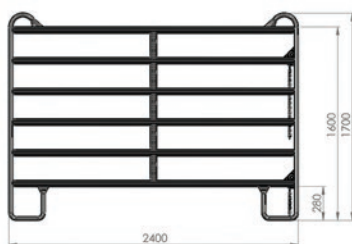

442591

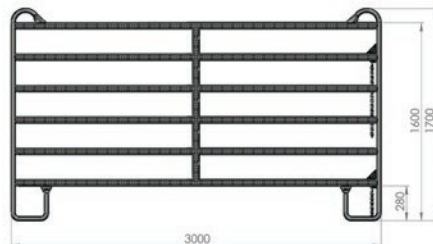

442592

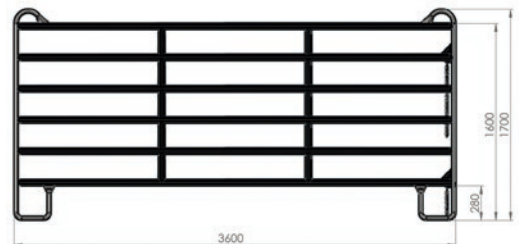

442593

Fence Panel with Gate

- allows an opening to be created in the fencing
- gate width 1 m
- lock for opening and closing the fenced area

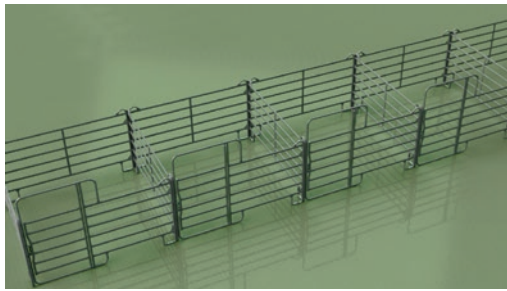

Example for mounting

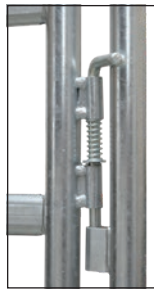

Locking bolt

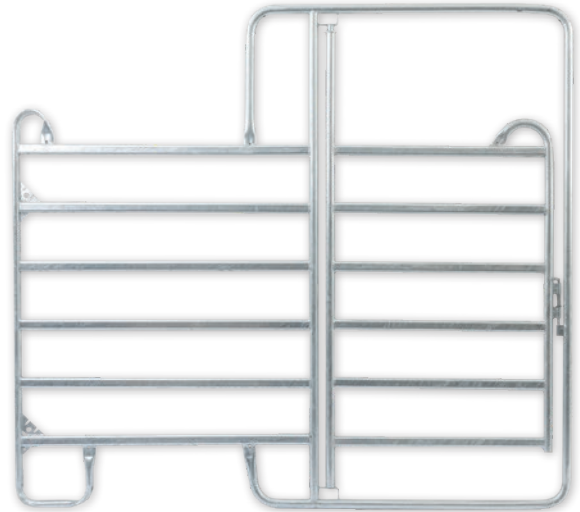

Ref. no.	Description	Material	Length	Height			€
442594	Fence Panel with Gate	steel, hot-dip galvanised	240 cm	220 cm	1	18	
442595	Fence Panel with Gate	steel, hot-dip galvanised	300 cm	220 cm	1	18	
442596	Fence Panel with Gate	steel, hot-dip galvanised	360 cm	220 cm	1	18	

Please note separate freight costs.

Panel cover penetration protection

- innovative and robust solution as step protection for pasture gates and panels: eliminates the risk of horses getting their heads or legs caught between the steel tubes and getting stuck
- ideal for mobile stables, paddocks and partitions, exclusively for outdoor use in agriculture or industry
- compatible with all commercially available pasture gates and panels
- suitable for various sizes and breeds of horse
- by combining several panel covers, any size of pasture gate or panel can be covered, size customisable
- easy and problem-free to install thanks to low product weight and delivery including necessary mounting parts and pre-drilled holes
- Protection against wind and draughts for horse and bedding or feed without darkening the area behind it
- Material: PVC, UV-stabilised



can be used for panels and pasture gates

Included in delivery: 1 x PVC tarpaulin 1.5 m x 1 m x 2.5 mm, Screws, washers, nuts and cable ties, assembly instructions

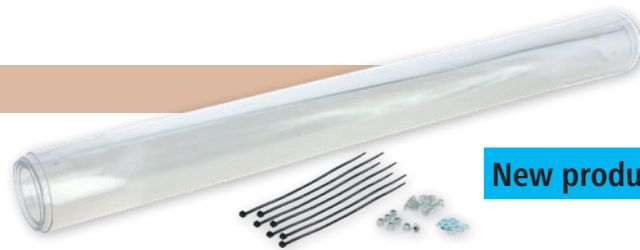

New product

Ref. no.	Colour	Length	Width	Material thickness			€
442628	transparent	1,5 m	1 m	2,5 mm	1	54	

Wall/floor Bracket for Pasture Panels

- for fixing pasture panels or modular hoardings to the wall or ground
- by omitting the screw close to the wall, panels can also be fixed at a slight angle to compensate for small slopes or inclines in the terrain
- Material: hot-dip galvanised metal



Ref. no.		€
442573	1/10	

Connector for Pasture Panels

- ideal for connecting two pasture panels (flat oval tubes)
- we always recommend the use of two connectors for a secure connection of two pasture panels
- also enables the connection of pasture panels across corners
- suitable for all pasture panels with/without gate
- Material: hot-dip galvanised metal





Ref. no.		€
442574	1/20	



Four-sided manger for palisade feeding grid

- universal hay rack for horses and cattle
- suitable for round and rectangular bales up to 1.8 m in length or diameter
- extremely stable design, high material thickness, 2 square pipe beams
- 2 sides can easily be opened for filling
- height-adjustable runners (adjustable to the animal's size)
- three-point attachment
- very little food loss
- supplied as a construction kit including circumferential roof edge protection, three-point safety clip
- Internal trough dimensions: approx. 2.0 x 2.0 m
- Material: hot-dip galvanised metal



Ref. no.	Length	Width	Height	Feed areas			€	
291255	212 cm	212 cm	250 cm	12	1	6		

Please note separate freight costs.

Square Hay Rack for Horses with Safety Feeding Barrier

- Feed rack for horses with 12 feeding places
- suitable for round and rectangular bales up to 1.8 m in length or diameter
- extremely stable design, high material thickness, 2 square pipe beams
- 2 sides can easily be opened for filling
- height-adjustable runners (adjustable to the animal's size)
- three-point attachment
- very little food loss
- supplied as a construction kit including circumferential roof edge protection, three-point safety clip
- Internal trough dimensions: approx. 2.0 x 2.0 m
- Material: hot-dip galvanised metal



Ref. no.	Length	Width	Height	Feed areas			€	
291256	212 cm	212 cm	250 cm	12	1	6		

Please note separate freight costs.



Three point attachment (with safety guard)



Circumferential roof edge protection



2 square tubular supports for even more stability

When used with feeds that may attack the galvanised surface (e.g. silage), apply a protective coat of paint first.

Hay Bell for Round Bales

- for round bales with max. \varnothing 160 x H 125 cm or \varnothing 130 x H 135 cm
- shatter-proof, frost-proof plastic material with built-in UV protection
- sturdy construction
- with animal-friendly and non-damaging food openings
- water-removing rain channels over the food openings
- with integrated carrying handle, suitable for front loader forks
- with integrated fixing eyelets for fixing the base to the hay bell
- base (available separately) for dry storage of the bales – can be locked for transportation with the hay bell











14559

Technical data	14557	14558
Height	164 cm	164 cm
Exterior diameter	185 cm	185 cm
Interior diameter	160 cm	160 cm
Feed areas	5	10

Made in the EU



Ref. no.	Colour	Suitable for			€	
14557	olive green	Cattle / Horses	1	6		
14558	olive green	Sheep / Goats / Calves / Ponies	1	6		

Ref. no.	Description	Colour	Material	suitable for		€	
14559	Base for Hay Bell	olive green	plastic, UV-stabilised	14557, 14558	1		
14556	Floor Anchor for Hay Bell and Base		metal	14557, 14558, 14559	1/10		

Please note separate freight costs.

Square hay rack Hobby

- suitable for round and rectangular bales up to 1.4 m in length or diameter
- ground tub reinforced with 2 additional pipes
- 2 sides can easily be opened for filling
- newly developed three-point linkage with foldable mountings for the tractor drawbar
- very little food loss
- Internal trough dimensions: approx. 1.45 x 1.45 m
- height-adjustable runners (adjustable to the animal's size)
- Supplied as a construction kit including circumferential roof edge protection
- Material: hot-dip galvanised metal



When used with feeds that may attack the galvanised surface (e.g. silage), apply a protective coat of paint first.

Ref. no.	Length	Width	Height	Feed areas			€	
291300	150 cm	150 cm	240 cm	8	1	6		

Please note separate freight costs.



Round rack with 8 feeding slots

for loose feed or small high-pressure bales

- palisade feeding grid
- supplied as a kit
- 4-part, can be transported in an estate car
- outdoors or in play pens, the segments can also be used to set up wall or corner mangers
- no three-point hitch
- Material: hot-dip galvanised metal

Technical data	291257
Height	116 cm
Exterior diameter	150 cm
Interior diameter	132,5 cm
Feed areas	8

Ref. no.			€	
291257	1	5		



Please note separate freight costs.

Round rack with 12 feeding slots

for normal and round bales

- palisade feeding grid
- 3-piece
- three-point attachment
- supplied as a kit
- Material: hot-dip galvanised metal

Technical data	291258
Height	116 cm
Exterior diameter	236 cm
Interior diameter	219 cm
Feed areas	12

Ref. no.			€	
291258	1	5		





Please note separate freight costs.

Slow Feeding Net

The net is placed over the food/bales so that the animals eat more slowly and thoroughly, helping to improve their digestion.

- reduced dust formation
- appropriate feeding
- little food is wasted
- with rubber cord
- Material: Polypropylene



Ref. no.	Colour	Length	Width	Mesh size			€
291260	green	3,6 m	2,4 m	45 x 45 mm	1/6	48	
291261	green	3,6 m	2,4 m	100 x 100 mm	1/10	80	
291262	green	2,8 m	2,8 m	45 x 45 mm	1/6	72	
291263	green	2,8 m	2,8 m	100 x 100 mm	1/12	96	
291352	green	3,6 m	2,4 m	30 x 30 mm	1/4	32	
291353	green	2,5 m	2,5 m	45 x 45 mm	1/6	48	
291354	green	3,5 m	3,5 m	45 x 45 mm	1/4	32	



Ref. no.	Description	Material	Length	Width	suitable for		€
291344	Frame for Slow Feeding Net	galvanised metal	181 cm	181 cm	291255, 291256, 291289	1	

NEW

cit Fly Trap FlyCage6

- extremely effective and generously dimensioned fly trap for pastures, gardens, campsites, etc.
- filled with the special FlyCage attractant mixture, up to 90 % of the flies from the environment are caught
- with the original FlyCage attractant, the trap works for up to 3 months
- reusable after refilling with attractant
- only for outdoor use, ideally from April to October
- for best catching success use only original FlyCage fly attractant
- Capacity: 6 l water and 750 g FlyCage fly attractant
- Material: Plastic

Mixing ratio:

- FlyCage fly attractant with water in a ratio of 1:8



Only for outdoor use with optimal effect from April to October.

Take care when using biocides. Always read the label and product information before use!

Ref. no.	Description				€	Made in the EU
299135	incl. cover, 6 grid inserts and 750 g attractant		1	48		

Ref. no.	Description	Material	suitable for	Contents	MOQ	Pieces / unit		€
15455	cit Fly attractant FlyCage			750 g / Pack			1/6	
299137	Cover for fly trap FlyCage6	Plastic					1/65	
299138	Grid insert for fly trap FlyCage6	Plastic			1 pack	6 / pack	1/280	
299139	cit Fly trap with 6 holes without accessories	Plastic					1	
323506	Wall Mount	galvanised metal	323500, 326102, 326103, 3224774, 323509, 299135				1/10	
326104	Floor bracket	galvanised metal	323520, 326102, 326103, 3224774, 299135, 3230309				1	

cit Fly Trap FlyCage3

- mechanical fly control with natural attractant trap
- simple and effective
- incl. attractant for an area up to 100 m²
- effective for 4 - 6 weeks depending on weather conditions, contents with dead flies can be disposed of in organic waste
- reusable after refilling with attractant
- Material: Plastic

Included in delivery: 1 x FlyCage3 Fly Trap, 1 x 25 g fly attractant

Ref. no.	Height	Effective area			€
299131	14 cm	- 100 m ²	1/24	864	

Ref. no.	Description	Contents		€
15454	cit Fly attractant FlyCage	4 x 25 g / Pack	1/12	



15454

Only for outdoor use with optimal effect from April to October.

Take care when using biocides. Always read the label and product information before use!



cit Insect Killers Halley LED

The fly killers from the Halley LED series delivering 3500 Volts of high voltage ensure the super-effective extermination of flies and insects with very low energy consumption.

- newly developed fly killer series with LED UVA lamps
- 3500 Volts high voltage for effective fly and insect extermination
- IPX4 splash-proof for use in stables or humid environments
- lightweight aluminium construction
- Including suspension chain and collecting tray
- latest-generation LED technology for high insect attraction with lowest energy consumption



Technical data	299991	299993	299992	299994
Voltage	220 - 240 V	220 - 240 V	220 - 240 V	220 - 240 V
Mains frequency	50 Hz	50 Hz	50 Hz	50 Hz
Effective area	150 m ²	250 m ²	150 m ²	250 m ²
High voltage	3.500 V	3.500 V	3.500 V	3.500 V
Lamp hours of operation	approx. 15.000 h	approx. 15.000 h	approx. 15.000 h	approx. 15.000 h
Housing material	Aluminium	Aluminium	Aluminium	Aluminium
Dimensions (W x D x H)	50,3 cm x 13 cm x 34,2 cm	66,3 cm x 13 cm x 52 cm	50,3 cm x 13 cm x 34,2 cm	66,3 cm x 13 cm x 52 cm
Protection class	IPX4	IPX4	IPX4	IPX4

Ref. no.	Description	Lamp colour			€
299991	LED 30	blue	1/2	32	
299993	LED 40	blue	1/2	18	
299992	LED 30	green	1/2	40	
299994	LED 40	green	1/2	18	

Ref. no.	Description	Output	Colour		€
299995	LED Replacement Bulb for Halley LED 30	9 W	blue	1/100	
299997	LED Replacement Bulb for Halley LED 40	12 W	blue	1/100	
299996	LED Replacement Bulb for Halley LED 30	9 W	green	1/100	
299998	LED Replacement Bulb for Halley LED 40	12 W	green	1/100	

cit Insect Killers EcoKill Inox

The fly killer with splash-proof electronics! IPX4 ensures adequate safety in areas such as stalls, outdoors or simply anywhere that a certain level of moisture cannot be ruled out! Identical in terms of shape, performance data and design to the EcoKill Inox without splash protection!

- TÜV-GS approved

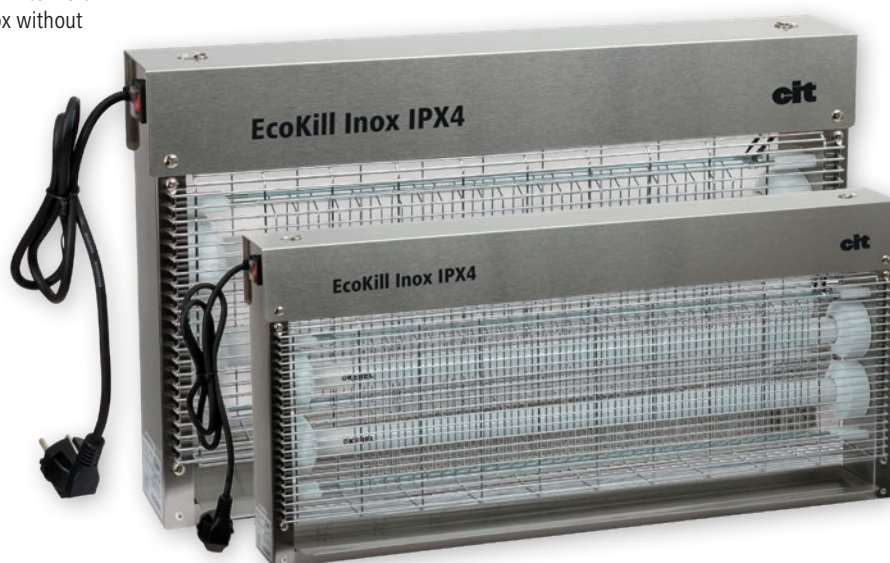

Technical data	299935	299936
Voltage	220 - 240 V	220 - 240 V
Mains frequency	50 Hz	50 Hz
Effective area	150 m ²	200 m ²
Housing material	stainless steel	stainless steel
Dimensions (W x D x H)	56 cm x 11,5 cm x 32,5 cm	72 cm x 12 cm x 32,5 cm
Protection class	IPX4	IPX4



Ref. no.	Lamps			€
299935	2 x 15 W	1/3	48	
299936	2 x 18 W	1/2	30	

Ref. no.	Description	Output	Colour		€
299986	Spare Pipe	15 W	blue	1/100	
299987	Spare Pipe	18 W	blue	1/25	

cit Insect Killers EcoKill Inox

The electric fly killer with a high-quality stainless steel housing. All EcoKill Inox models are TÜV-GS tested and fitted with long-life UV lamps. The high-quality stainless steel matte-look housing is easy to clean and retains its attractive surface for years. The slim design with the exposed mesh facilitates optimum capture properties.

- extremely robust thanks to stainless steel housing
- Including suspension chain and collecting tray
- outstanding value for money
- corrosion-resistant and scratchproof
- special UVA lamp which is very attractive to insects
- TÜV-GS approved



Technical data	
Voltage	220 - 240 V
Mains frequency	50 Hz
Effective area	80 m ²
High voltage	2.200 V
Housing material	stainless steel
Dimensions (W x D x H)	34 cm x 11,5 cm x 32,5 cm



Ref. no.	Description	Lamps			€
299930	Model 2012	2 x 6 W	1/3	108	

Ref. no.	Description	Output	Colour		€
299812	Spare Pipe	6 W	blue	1/25	

cit Insect Killers EcoKill LED

• includes LED lamp for low power consumption and very long life • extremely lightweight aluminium construction • Including suspension chain and collecting tray • excellent value for money • corrosion-resistant and scratchproof • special LED UVA lamp which is very attractive to insects

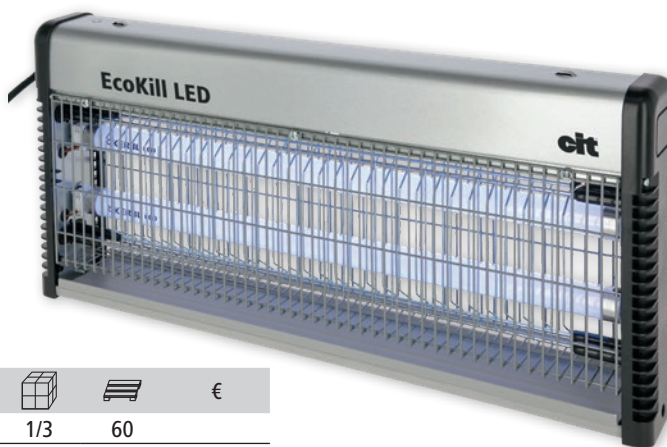

Technical data	299938
Voltage	220 - 240 V
Mains frequency	50 Hz
Effective area	150 m ²
High voltage	2.200 V
Lamp hours of operation	approx. 15.000 h
Housing material	Aluminium
Dimensions (W x D x H)	48 cm x 7 cm x 26 cm

Ref. no.			€
299938	1/3	60	

Ref. no.	Description	Output	Colour		€
299944	LED Replacement Bulb	7 W	green	1/100	
299988	LED Replacement Bulb	7 W	blue	1/100	

NEW

cit Fly roll MuscaRoll

• glue trap for controlling flies and flying insects • suitable in accordance with applicable European organic farming directive • listed in the supplies list for ecological agriculture in Germany • 100 % non-toxic



Top Seller

suitable for organic farms



Ref. no.	Roll length	Roll width	Fastening			€
299907	7 m	30 cm	with hanger	1/15/30	540	
299908	9 m	30 cm	with hanger	1/15/30	540	
299790	10 m	25 cm	with tether	1/24	864	

cit Fly roll FlyMaster

Adhesive catcher with special 3D print to combat flies and flying insects

- the 3D printing simulates edges and stripes and thus potential landing sites for flies – this increases the attractiveness to flies
- with new improved adhesive coating
- suitable in accordance with applicable European organic farming directive
- listed in the supplies list for ecological agriculture in Germany
- 100 % non-toxic



Ref. no.	Roll length	Roll width	Fastening			€
299904	9 m	30 cm	with hanger	1/15	540	
299905	7 m	10 cm	with hanger	1/70	2.800	

suitable for organic farms



Made in the EU



cit Fly roll FlyMaster

- flies are attracted by the paper and remain stuck on the trap
- the new form of printing on yellow paper improves the attractant's appeal, since it simulates apparent landing spots
- simple - clean - non-toxic - 100 % effective
- listed in the supplies list for ecological agriculture in Germany



Top Seller

suitable for organic farms



Made in the EU



299847



299789



29978

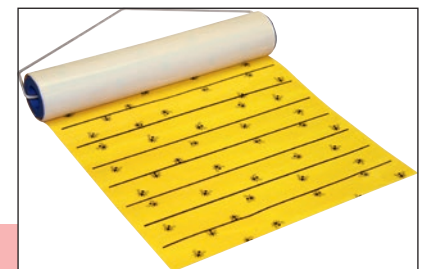

with yellow paper attractant

Ref. no.	Roll length	Roll width	Fastening			€
29978	7 m	30 cm	with hanger	1/15	540	
299847	9 m	30 cm	with hanger	1/15	540	
299789	10 m	40 cm	with hanger	1/15	450	

cit Stable Flycatcher Complete Set FlyMaster

- environmentally-friendly alternative for stable fly control
- spent material is rolled onto the empty reel (included)
- easy self assembly
- Spare rolls can be easily replaced
- suitable in accordance with applicable European organic farming directive
- listed in the supplies list for ecological agriculture in Germany

suitable for organic farms



Made in the EU



100 % non-toxic



Ref. no.	Description	Roll length			€
29976	Adhesive tape	400 m	1	96	
299776	Adhesive Cord	440 m	1	96	

Ref. no.	Description	Roll length		€
29977	cit Roll Stable Flycatcher FlyMaster Adhesive tape	400 m	1	
299777	cit Roll Stable Flycatcher FlyMaster Adhesive Cord	440 m	1	

cit Stable Flypaper Sheet FlyMaster

• 6 sheets each 595 x 300 mm • flyMaster Flypaper reliably catches flies due in stables, milking parlours and inside houses • You can catch up to 5,000 flies and/or cover around 200 m² with one sheet • Usage: Hang the whole or cut fly sheet – remove protective film – finished! • suitable in accordance with applicable European organic farming directive • 100 % non-toxic

suitable for organic farms



Made in the EU



with yellow paper attractant

Ref. no.	Length	Width			€
299842	59,5 cm	30 cm	1/60	1.400	

cit Fly Catcher Twister

• the glued paper strip is made from natural ingredients such as resins, oils and fats • the free-hanging fly trap provides the perfect landing pad for flying insects • use the red strap to carefully pull the rolled-up twister out of the luke-warm case and use the tacks provided to fasten to the ceiling • Supplied with a display when purchasing 24 pieces. • 4 piece / box • suitable in accordance with applicable European organic farming directive

suitable for organic farms



The classic one – 100 % non-toxic!

Ref. no.	MOQ	Pieces / unit			€
299839	1 pack	4 / pack	1/24/144	3.456	

cit Vermin Deterrent UltraStop

• uses ultrasound to repel mice, rats and other pests from within a radius of 350 m² • with pivoting bracket • low power consumption • with LED display for operation control • 100 % non-toxic • only suitable for indoor use



Technical data	299642
Voltage	220 - 240 V
Mains frequency	50 - 60 Hz
High frequency	20.000 - 27.000 Hz
Effective area	350 m ²
Housing material	Plastic
Weight	170 g

Ref. no.	Colour	Plug type			€
299642	white	Plug-in Power Supply with Euro Flat Plug	1/30	720	

2			
2in 1 Leather lotion	143	BigScreen Digital thermometer	160
2K Brush	126	Biotin Pellets	169
2K Hoof pick	127	Bit Guards	61
2K Mane brush	126	Bite protection tape	61
2K Spiral Curry Comb	127	blade set Cryogen-X	194
2K Sweat Scraper	127	blade set Favorita	185
		blade set SnapOn	189
3		Blade Set SnapOn Stainless Steel	190
3in1 Leather Care	143	Blade set with DLC coating Favorita	184
		BladeCool 2.0	195
A		Blanket and saddle cloth holder	212
A6 Clipper	193	Blanket Bag Milano	139
Absorba Padding Fleece	155	Blanket rack	211
Absorbent Cotton in Gauze Cover		Blanket Rack, 4-tier	211
CottoMull	156	BlauCare	157
Active Jacket	9	Blouson Jacket	8, 25
Active Shirt	10	Blue Spray	159
Adhesive tape	276	Bluetooth Microphone	198
Airbag Vest Manege	45	Bonum Pro Cordless Clipper	176
AiRide Riding pad	52	Bootjack	31
AirOne Flex Battery Ultrasound Inhaler for Horses	204	Boots NeoLite	29
AirOne Ultrasound Inhaler for Horses	205	Botfly Knife	163
AKS Liquid	259	Box Bag Milano	138
AKS Paste	259	Bracket for Action Cam	198
Alaska 2.0 Thermal Overtrousers	24	Breastplate	65
All-Purpose Bucket	217	Breastplate LED	72
All-Purpose Bucket Jumbo	218	Bremsentod (Horsefly Killer) Protection Spray	163
All-round Box	141	Brescia Riding Socks	33
Aluminium Adhesive Tape	276	Bridle Coldblood	65
Aluminium feed trough	213	Bridle Rack	212
Aluminium Shovel	237	Bridle Reins	66
Aluminium Shovel Profi	236	Bridle, Swedish	63
Aluminium Telescopic Handle	236	Bronchial Horse Lick	168
AluSafe Grooming Box	139	Brow strap LED	72
American Lead Rope	85	Brow Strap, Straight Clincher	62
Anatomic Snaffle	63	Brush 2K	126
Animal animal Care Oil	158	Brush Nature	119
animal Care Oil Animal	158	Brush Set Classic	117
Animal Scales	257	Brush Set CornFlowers	119
Antana Riding Gloves	36	Brush Set Jellyfish	117
AntiSlip Corrector Saddle Cushion Faux Fur	56	Bucket Holder	218
AntiSlip Rubber reins	66	Bucket Mount	218
AntiSlip Saddle Underlay	57	Bull-Snap Lead Rope	85
Arrezzo Grooming Box	137		
Aubiose Litter fork	235	C	
Avina Bell boots	104	C10 Circulation Pump	277
Avina Soft gaiters	103	Camera	200
Axona Riding half-boots	30	Cancon Snaffle	64
		Candy	168
		Carbon Dressage crop	47
		Carbon Jumping whip	47
		Care Bag	124
		Care Bag Lilli	123
		Cast and support dressing TechnoCast	155
		Cavesson Leather Exklusiv	69
		Ceiling bracket for hanging	211
		Ceiling Mount, 3-arm	212
		Chalk marker	259
		Chest extension	96
		Chopping Blade	151
		Circulation Pump C10	277
		CLAC Insect Protect Gel	164
		CLAC Insect Protect Spray	164
		Classic Brush Set	117
		Classic Fly Mask	100
		Classic Snaffle	64
		Classic Thermal Boots	28
		Classic Treat Cube	167
		ClassicSoft Halter	79
		ClassicSoft Lead Rope	79
		ClassicStar Riding Breeches	20
		ClassicStar Riding Tights	21
		ClassicStretch Mini Chaps	32
		Classy Lead Rope	76
		Classy Halter	76
		Claw and pad bandage CottoPad	156
		Clay Gel	111
		Cleaning Brush coarse	122
		Cleaning Brush soft	122
		Cleaning Lotion EasyCare	114
		Cleaning sponge	134
		Climbing aid	210
		Clincher Brow Strap, Straight	62
		Clincher Snaffle	62
		Clipper A6	193
		Clipper Econom II	178
		Clipper FarmClipper4	181
		Clipper Favorita II	183
		Clipper Favorita SPEED	183
		Clipper Golden A5	193
		Clipper Oil	195
		Closing Option for Pasture Gate Mounting Set	281
		Coat and Mane Brush Kinder-Wurzel	131
		Coat and Mane Brush Wurzel	131
		Coat Cleaning Stone WonderStone	134
		Coat Gloss Spray Foxfire	111
		Coat Gloss Spray ManeCare	114
		Coat Gloss Spray ManeCare Premium	114
		Coat Thinning Shears	136
		Combi Horse Brush	121
		Comfort Pro LED Flood Light	246
		Competition Shirt	7
		Compression socks Janne	34
		Connector for Pasture Panels	283
		Connector set for IBC container	269
		Connector Set for Pasture Pump	268
		constanta Shearing Blade Set	180
		Control for LED lighting	249
		Cooling Balsam Equifresh	115
		Cooling gaiters	106
		Cooling Gel EquiMint	115
		CoolSpray	195
		Cordano Halter	82
		Cordless Clipper Bonum Pro	176
		Cordless Clipper Cordless Turbo A5	194
		Cordless Clipper CuttoX	191
		Cordless Clipper DeloX	190
		Cordless Clipper DropiX	191
		Cordless Clipper Durati	186
		Cordless Clipper Durati Horse	187
		Cordless Clipper Econom CL	177
		Cordless Clipper FarmClipper Akku2	181
		Cordless Clipper FAV5 CL Horse	188
		Cordless Clipper Favorita CLi	182
		Cordless Clipper Onyx	192
		Cordless Clipper Sonic	192
		Cordless Turbo A5 Cordless Clipper	194
		Corner hay rack	230
		CornFlowers Brush Set	119
		Corrector Saddle Cushion Faux Fur	56
		Corrector Saddle Cushion Faux Fur AntiSlip	56
		CottinoStar Padded Bandage	155
		CottoMull Absorbent Cotton in Gauze Cover	156
		Cotton leash with chain	85
		Cotton Roll VisCotto	155
		CottoPad Claw and pad bandage	156
		Covalliero Therm Gaiters	109
		CovallieroTherm Bandaging underlay	110
		CovallieroTherm Fleece Bandage	110
		CovallieroTherm Fleece blanket with neck piece	109
		CovallieroTherm Saddle Pad	110
		CovallieroTherm Stable gaiter	110
		Cover for Buckets and Feeding Bowls	218
		Cover for Pasture Gates	281
		Cryogen-X blade set	194
		Cuddle brush for horses	130
		Curry Comb Deluxe	128
		Curry comb Der Gute	131
		Curry comb Flex 2K	127
		Curry comb New Generation	131
		Curved Saddle Strap	59
		Cutting Blade with Handle	151
		CuttoX Cordless Clipper	191
		D	
		Dana Riding Gloves	36
		DeadSea Liquid Nebuliser Solution	203
		Delicious Cubes Original	166
		Delicious Cubes with Apple	166
		Delicious Cubes with Banana	166
		Delicious Cubes with Carrot	166
		Delicious Cubes with Herbs	166
		DeloX Cordless Clipper	190
		Deluxe Curry Comb	128
		Deluxe Hoof pick	129
		Deluxe Mane brush	128
		Deluxe Scrubbing Brush	128
		Deluxe Spiral Curry Comb	129
		Deluxe Sweat Scraper	129
		Der Gute Curry comb	131
		DERMOCAN Horse shampoo	111
		Desino Jod Plus Disinfectant Spray	157
		Device and Broom Handle	236
		Dexter Transport Gaiters	101
		Diamond Sharpening Rod	151
		DigiScale 1000 Digital Suspension Scale	256
		DigiScale 300 Digital Suspension Scale	256
		DigiScale 50 Digital Suspension Scale	256
		Digital Suspension Scale DigiScale 1000	256
		Digital Suspension Scale DigiScale 300	256
		Digital Suspension Scale DigiScale 50	256
		Digital thermometer	160
		Digital thermometer BigScreen	160
		Digital Thermometer for Large Animals	160
		Digital thermometer topTEMP	160
		Disinfectant INTERKOKASK®	158
		Disinfectant Spray Desino Jod Plus	157
		Diva Lambskin Brush	132
		Doria Halter	77
		Doria Lead Rope	77
		Double Brush Putzi	130
		Double float drinker for pasture barrel attachment S60	270
		Double Float Drinking Bowl S60	270
		Double Hay Rack	230
		Double Lunge Soft	70
		Dressage / Riding Crop	49
		Dressage crop	47, 48, 49
		Dressage crop Carbon	47
		Dressage Crop with Keeper	49
		Dressage Gaiters Fleece	102
		Drinking Bowls G20	261
		Drinking Bowls K50	265
		Drinking Bowls K71	263
		Drinking Bowls K75	263
		Drinking Bowls KN50	264
		Drinking Bowls Mod. 221500	261
		Drinking Bowls Mod. 222000	262
		Drinking trough with float valve	266
		DropiX Cordless Clipper	191
		Dubbin	142, 144
		Durati Cordless Clipper	186
		Durati Horse Cordless Clipper	187
		E	
		E21 Water Bowl with Pipe Valve	260
		EasyCare Cleaning Lotion	114
		EasyOut Tray for taking off shoes / boots	32
		Eclipse Helmet	40
		Eclipse Polo Helmet	40
		Eco Foal Head-Collar	83
		Eco Halter	82
		EcoFlex Hoof Stand	150
		EcoFork Litter fork	234
		EcoFork Mini Litter fork	234
		EcoKill Inox Insect Killers	289
		EcoKill LED Insect Killers	290
		Econom CL Cordless Clipper	177
		Econom II Clipper	178
		Econom Shearing blades	179
		Economic Riding Breeches	19
		EcoTUBE Plus LED Tube	252
		Eggbutt	61
		Eimer-machers Horse Balm	158
		Elasto Half Chaps	32
		Electrics Kit for Fence Gates	281
		Elite Helmet	41
		Elite Polo Helmet	41
		Empara Fleece Bandage	107
		Empara Fly Mask	100
		Empara Saddle Pad	54
		Equifresh Cooling Balsam	115

EquiLastic Self-adhesive Bandage	154	Fly Mask with Ear and Nose Protection	97	Halter TopLine	74	Hoof Stand EcoFlex	150
EquiMint Cooling Gel	115	Fly Mask with Ear and Nostril Protection	97	Halter with Integrated Fly Mask	98	Horse brush	124, 125
Equisal DarmoFin Herbal Lick	171	Fly Mask with Ear Cut-outs	97	HangOn 13L Feed trough	216	Horse brush Groovy	131
Equisal Mineral Lick	171	Fly Mask with Ear Protection	99	HangOn 22L Feed trough	216	Horse brush Junior	130
Equisal NoFly Mineral Lick	171	Fly Mask with Ear Protection and Nostril Cord	97	HangOn 8L Feed trough	216	Horse brush Lilli Starlight	123
Equona Riding Tights	22	Fly Mask with Ear Protection SuperFly	98	HAPPYCOW Post Scrubber	244	Horse brush MiniDolly	130
eXite Helmet	42	Fly Mask Zebra with Ear Protection	98	Hay bag	228	Horse brush WaterLily	120
Exklusiv Cavesson Leather	69	Fly roll FlyMaster	290, 291	Hay Ball Flex	174	Horse Hair Finishing Brush	122, 124
Expert Hoof and claw knife	149	Fly roll MuscaRoll	290	Hay Bell for Round Bales	285	Horse Hair Finishing Brush Lilli Starlight	123
Expert Hoof and Claw Knife Danish Design	150	Fly Strip Curtain Set PVC	242	Hay Cutter TF 2000 M	231	Horse Hair Finishing Brush WaterLily	120
Extension for Heated Rod	276	Fly thread strap	99	Hay net	227	Horse Halters Royal	75
		Fly Trap FlyCage3	287	Hay net FlexiStrong	227	Horse Lick Bronchial	168
F		Fly Trap FlyCage6	287	Hay Net for Round Bales	226	Horse play ball	174
FarmClipper Akku2 Cordless Clipper	181	FlyCage3 Fly Trap	287	Hay net Nova	225	Horse salt shower starter kit	113
FarmClipper4 Clipper	181	FlyCage6 Fly Trap	287	Hay Net Retaining Hook	225	Horse shampoo DERMOCAN	111
FarmLINE LED moisture-proof lamp	253	FlyMaster Fly roll	290, 291	Hay Net Set of 10	225	Horse shampoo with wheat proteins	116
Faux Fur Set for Halter	56	FlyMaster Stable Flycatcher Complete Set	291	Hay Net Set of 5	225	Horse Shoe	153
faux fur short harness	58	FlyMaster Stable Flypaper Sheet	292	Hay Net with Filling Aid	224	Horse toy	175
FAV5 CL Horse Cordless Clipper	188	Foal Head-Collar Eco	83	Hay Net with Ring	224	Horse toy KniStar	175
Favorita blade set	185	Foal Head-Collar TopLine	74	Hay Net, Tunnel Shape	224	Horsefly Protection Cream TaonX	162
Favorita Blade set with DLC coating	184	Fodder rack HayBox	231	Hay Rack	229	Horsefly Protection Spray TaonX	162
Favorita Cli Cordless Clipper	182	Food Box Stackable	220	Hay Rack Half-round	230	Horsefly Protection Spray TaonX Booster	162
Favorita II Clipper	183	Four-sided manger for palisade feeding grid	284	HayBag	228	Horsefly trap TaonX	161
Favorita SPEED Clipper	183	Foxtire Coat Gloss Spray	111	HayBox Fodder rack	231	Horsefly trap TaonX Mini	161
Feed and Water Pail FlatBack	222	Frost protection heating pipe 24 V	276	HeadFire 280 sensor LED head lamp	71	HP20 Water Bowl Heatable	272
Feed Ball Toy	173	Frost protection heating pipe with thermostat	275	Helmet Beauty 2.0	43	Hypofekt	35
Feed Ball Toy Soccer	173	Frost Protection Thermostat	276	Helmet Case	43		
Feed bin	221			Helmet Eclipse	40		
Feed Scoop	238, 239	G		Helmet Eclipse Polo	40		
Feed shovel digital	239	G16 Water Bowl with Stainless Steel Tongue	262	Helmet Elite	41		
Feed Storage Rack	230	G20 Drinking Bowls	261	Helmet Elite Polo	41		
Feed trough	214, 215, 216	G51 Water Bowl with Pipe Valve	260	Helmet eXite	42		
Feed trough HangOn 13L	216	Gaiters Covalliero Therm	109	Helmet Nerron	42		
Feed trough HangOn 22L	216	Gaiters TecAir	102	Helmet storage	210		
Feed trough HangOn 8L	216	Garlic Plus Pellets	164	Herbal Lick Equisal DarmoFin	171		
Feed Trough Long	214	Garlic powder	164	Herbal Liquid	203		
Feeding Bowl	217	Girth	58	High-visibility gaiters	73		
Feeding Trough Corner Model	215	Gloria Riding Gloves	37	High Visibility Vest	71		
Feeding Trough Stainless Steel	213	GoBag Bag	223	HighWaist Riding Breeches	17		
Feeding Trough with Metal Bars	214	Golden A5 Clipper	193	HighWaist Riding Tights	16		
Fence Panel with Gate	283	Grado Riding Socks	34	HiLED Evo LED light	253		
Fetlock Boots TecAir	102	Grain shovel	237	HiLED Pro LED light	250		
Fetlock gaiter	101	GrainFree Treat Cube	167	Hippo Halter	81		
Fetlock Shears	157	Grooming Bag	139	Hippo Lead Rope	81		
Filling Aid for Hay Nets	227	Grooming Bag Milano	138	HK Pregnancy Testers for Horses	203		
FinoStretch Fly Bonnet	99	Grooming Box 7-piece filled	140	Hobby Square hay rack	285		
FinoStretch Zipper Fly Bonnet	99	Grooming Box 8-piece filled	140	Holder for Wall Mounting Mistboy	232		
FlatBack Feed and Water Pail	222	Grooming Box AluSafe	139	Holding Leather Strap	57		
FlatBack Safety Wall Bracket	222	Grooming Box Arrezzo	137	Hoof-Checking Pliers	152		
Flaxseed Oil LinoPur	169	Grooming Box Jumbo	137	Hoof & Claw Spray	159		
Flecki Sponge	134	Grooming Box Roma	138	Hoof and claw knife	149		
Fleece Bandage CovallieroTherm	110	Grooming Box Siena	137	Hoof and claw knife Danish Design Expert	150		
Fleece Bandage Empara	107	Grooming Box WaterLily	140	Hoof and claw knife Expert	149		
Fleece Blanket RugBe Economic	92	Grooming Brush	125	Hoof and claw knife ProCut	150		
Fleece Blanket RugBe Royal	93	Grooming glove	133, 135	Hoof and claw knife Profi	149		
Fleece blanket with neck piece CovallieroTherm	109	Grooming Rucksack	139	Hoof and claw knife ProfiCurv	148		
Fleece Glove Xaina	39	Groovy Horse brush	131	Hoof and claw knife ProfiLoop	148		
Flex 2K Curry comb	127	Ground Work Rope	85	Hoof and claw knife SuperProfi	148		
Flex 2K Nubbed Curry Comb	127	Guard	264	Hoof Balm Strengthener	146		
Flex Hay Ball	174	Guide Leash with Chain	85	Hoof Bandage Silbertape	154		
Flex HorseHair 2K	126			Hoof Bandage Typ 513	154		
Flex NatureBristles 2K	126			Hoof Bandage VetTape	154		
Flex Riding Socks	34			hoof boots rubber with teddy fleece	106		
FlexBag Flexible Trough	219			Hoof Brush with Can	147		
FlexFire 1000 LED Torch	254			Hoof Brush with Cap	147		
Flexible Trough FlexBag	219			Hoof Fat	145, 146		
FlexiStrong Hay net	227			Hoof gel Pro	145		
Float Bowl S30	267			Hoof Nail Clinch	152		
Float Bowl S522	266			Hoof Oil	146		
Float Set for Pasture Pump	268			Hoof oil Premium	145		
Float Water Bowl Heatable SH30	273			Hoof Oil Strengthener	146		
Fly blanket RugBe SuperFly	94			Hoof Pick	147		
Fly blanket RugBe Zebra	95			Hoof pick 2K	127		
Fly Bonnet FinoStretch	99			Hoof pick Deluxe	129		
Fly Bonnet FinoStretch Zipper	99			Hoof pick Lilli Starlight	123		
Fly Catcher Twister	292			Hoof pick WaterLily	120		
Fly Mask Classic	100			Hoof Pick with Brush	147		
Fly Mask Empara	100			Hoof Pick with Horse's Head	147		
Fly Mask Linea	100			Hoof pliers	152		
				Hoof Rasp	151		
				Hoof Rasp with Handle	151		
				Hoof Shoe	106		
				Hoof Shoe Tubbease™	153		

Sheet-metal punch	62	Surveillance Camera	201	Washing brush	135
Shoeing Hammer	152	Suspended Dial Balance Premium	258	Water and feed trough	220
Shoeing Mallet	152	Sweat Scraper 2K	127	Water bowl for pasture barrel attachment	267
Short belt straight	59	Sweat Scraper Deluxe	129	Water bowl for pasture barrel attachment KN50	269
Show Jacket Parigi	6	Sweat Scraper Half-round	135	Water Bowl Heatable H10	271
Side reins	67	Sweat Scraper Straight	135	Water Bowl Heatable HP20	272
Siena Grooming Box	137	Swing-Through Lock for Fence Gates	281	Water Bowl with Pipe Valve E21	260
Silbertape Hoof Bandage	154			Water Bowl with Pipe Valve G51	260
Silver Spray	159			Water Bowl with Stainless Steel	262
Single brush Janne recycled	119	T		Tongue G16	262
Skin Care Balm SkinCare	113	Tail Guard	96	Water container for wheelbarrow	223
SkinCare Skin Care Balm	113	TaonX Booster Horsefly Protection Spray	162	H2GoBag	223
SlimLINE LED moisture-proof lamp	252	TaonX Horsefly Protection Cream	162	Water Snaffle, French link	61
Slow Feeding Net	286	TaonX Horsefly Protection Spray	162	Water Snaffle, hollow	61
SlowFeed Plus Wall Rack	229	TaonX Horsefly trap	161	Water trough	266, 267
SmartCam HD	201	TaonX Mini Horsefly trap	161	WaterLily Grooming Box	140
Snaffle Anatomic	63	TarPaste Beechwood Tar	157	WaterLily Hoof pick	120
Snaffle Cancun	64	TecAir Fetlock Boots	102	WaterLily Horse brush	120
Snaffle Classic	64	TecAir Gaiters	102	WaterLily Horse Hair Finishing Brush	120
Snaffle Clincher	62	Techno II Riding Breeches	27	WaterLily Mane brush	120
Snaffle Standard	65	TechnoCast Cast and support dressing	155	WaterLily Plastic Curry Comb	120
Snap-hook	207, 259	Teddy Fleece Bell boots	105	Web Draw Reins with Split Leather Loops	66
SnapOn blade set	189	Tether Chain	206	Weigh Scoop	238
Snow and grain shovel	237	Tether Ring	207	Weigh Scoop Inverted Handle	239
Soccer Feed Ball Toy	173	Therapy Play Ball for Horses	174	Western Saddle Holder	209
Soft	118	Thermal Boots Classic	28	Whip	50
Soft Double Lunge	70	Thermal Overtrousers Alaska 2.0	24	Whip Holder	51
Soft gaiters Avina	103	Thermal Winter Shoes Ottawa 2.0	28	Winter riding glove Mora	39
Soft gaiters Pelisa	103	Thermo Riding Skirt	23	Winter riding glove Nerica	39
Softlonge Lunge line	70	Thiedemann Reins	66	WonderStone Coat Cleaning Stone	134
Solar Battery Kit	202	Tie Strap adjustable	206	WorkFire 2200 Mobile LED spotlight	255
Solar Set	202	Tie Strap with Chain	206	WorkFire 350 LED hand lamp	255
SolarLED Elio LED Outdoor Spotlight	245	TopLine Foal Head-Collar	74	Wound care spray	157
SolarLED Solina LED Outdoor Spotlight	245	TopLine Halter	74	Wurzel Coat and Mane Brush	131
Sonic Cordless Clipper	192	TopLine Lead Rope	75		
Special Clay Balm	158	topTEMP Digital thermometer	160	X	
Spiral Curry Comb	133	Torqui Favorita Precision Adjusting Aid	184	Xaina Fleece Glove	39
Spiral Curry Comb 2K	127	Torqui Precision Adjustment Tool for Cattle / Horse Clippers	179	XL Scratch Brush	244
Spiral Curry Comb Deluxe	129	Tournament feed manger with hanging bracket and carrying handle	222		
Sponge	135	Tournament Number	141	Z	
Sponge Flecki	134	Trail Saddle Cloth Laguna	55	Zinc Oxide Spray	159
Sponge, Viscose	134	Transformer for trough heating	274		
Sporty Hold Spray	35	Transport and stall bandage	107		
Spray Rinser Komfort	258	Transport Gaiters Dexter	101		
Spring Hook	207	Transport Manger with Hanging Bracket	222		
Spurred Boot Protectors	35	Tray for taking off shoes / boots EasyOut	32		
Spurs with Straps	35	Treat Cube Classic	167		
Square Hay Rack for Horses with Safety Feeding Barrier	284	Treat Cube GrainFree	167		
Square hay rack Hobby	285	Treatment Shoe for Hooves	153		
Stabiliser for Adjustable Pasture Gates	281	Triangular Reins	66		
Stabilising Wheels for Wheelbarrow	223	Triangular Trough	213		
Stable and Transport Gaiters	101	Trough for concentrated feed	215		
Stable Blackboard	259	Tubease™ Hoof Shoe	153		
Stable Blanket RugBe	90	Twister Fly Catcher	292		
Stable Bolt	259	Typ 513 Hoof Bandage	154		
Stable Flycatcher Complete Set FlyMaster	291	Tyre Trough	215		
Stable Flypaper Sheet FlyMaster	292				
Stable gaiter CovallieroTherm	110	U			
Stable, Spreading and Manure Forks	233	Ulanta Riding Gloves	36		
Standard Mane brush	125	Ultrasound Inhaler for Horses AirOne	205		
standard pack	196	UltraStop Vermin Deterrent	292		
Standard Snaffle	65	Under-/stable blanket RugBe 2in1	89		
Stichfrei Mosquito Protection	165	Universal and mane scissors	136		
Sting Free Animal	165	Universal Broom	240		
Stirrup Inlay angled	60				
Stirrup Insert	60	V			
Stirrup Straps Leather	60	Vermin Deterrent UltraStop	292		
Stirrups	60	VetTape Hoof Bandage	154		
Stirrups Secure	60	Vienna Riding half-boots	31		
Stirrups without Inlay for Children	60	VisCotto Cotton Roll	155		
Street Broom Kompakt	240				
Street Brush extra-coarse	239	W			
Strip Curtain	241	Walking blanket RugBe	91		
Strip Curtain Set	241	Wall Rack SlowFeed Plus	229		
Suction Hose Set for Pasture Pump	268	Wall/floor Bracket for Pasture Panels	283		
SummerTech Riding Gloves	37				
SuperFly Fly Mask with Ear Protection	98				
SuperProfi Hoof and claw knife	148				
SuperSoft Halter	78				
Supreme Lead Rope	78				
Surcingle elastic	96				

Electric Fence 2025

Your Electric Fence Experts



Albert Kerbl GmbH

Felizenzell 9
84428 Buchbach
Germany
Telefon +49 8086 933-310
Telefax +49 8086 933-152
info@kerbl.com
www.kerbl.com

Kerbl Austria Handels GmbH

Wirtschaftspark 1
9130 Poggersdorf
Austria
Telefon +43 4224 81555-0
Telefax +43 4224 81555-629
order@kerbl-austria.at
www.kerbl-austria.at

We are constantly striving to improve our stock of products and keep them right up to date. We reserve the right to make design changes. The publication of this catalogue renders all previous catalogues and prices lists for these products invalid. All prices provided are the manufacturer's recommended retail prices and are inclusive of VAT. All information is subject to typesetting and printing errors. Price alterations and errors reserved. Colours and designs may vary due to printing processes. Reprinting – even just of extracts – is only permitted only with prior consent.

