

# Electric Fence 2025

Your Electric Fence Experts







## Information

Promotional Articles	6
General Information	12

## Fence devices

Smart fence devices	22
230 Volt Power Supplies	31
12 / 230 V Duo units	39
12 V Battery Units	45
Solar Units	56
Solar Modules	64
Metal Battery Cases	67
9 V Battery Energisers	69
Hobby Devices	76
Starter Kits	54

## Accessories

Fence Device Batteries	80
Testing and Control Equipment	84
Connection and Grounding Accessories	87
Fencing Accessories	94
Warning Signs	95
Reels	96
Post Reel Systems	99

## Conductors and Accessories

Tapes	104
Ropes	109
Polywires	112
Tape, Rope and Poly Wire Connectors	116

## Permanent Fencing Accessories

Fence Wires	121
Premium Horse Wire / TopLine Horse Wire	123
Permanent Fencing Accessories	125
Wire Connectors	129

## Fencing Posts

Wooden Posts	132
Recycled Posts	134
T-Post System	137
Metal posts	146
Fibreglass Posts	149
Plastic Posts	152

## Insulators

Ring Insulators	161
Slot Insulators	164
Special Insulators	165
Corner/strain insulators	166
Tape Insulators	168
Rope Insulators / Wire Insulators	170
Insulators with metric thread	172
Additional Insulators	174
Offset Insulators	176

## Gate components

Gate insulators	178
Gate Handles	182
Gate Systems and Accessories	186

## Pasture Gates, Panels and Racks

Pasture Gates	191
Paddock Panels	196
Fodder Racks	200

## Fence Netting

Sheep Netting	204
Wolf Defence	215
Wild Animal Deterrent	223
Small Animal Nets	225
Poultry Netting	226
Net Accessories	231

## Keyword index

Keyword index	238
---------------	-----



# Top New Products 2025



**Always up to the minute!**

Always keep up to date!

For all new products and offers, simply scan the code below, or visit us at [www.ako-agrar.de](http://www.ako-agrar.de).

We are also happy to advise you about this personally via telephone on in the pasture fence calculator chat function at any time.



**You will find these and other new products in this catalogue!**

## Smart technology

- App-controlled fence devices



Smart Energiser

Discover devices with smart functions in the „Smart products“ section!

from page 22

## Sheep nets for professionals

- Low weight, familiar quality



## Practical accessories

- Sturdy products for your pasture





# You will find these symbols in this catalogue.

## Explanation of our packaging and sales units.

MOQ	Pieces / unit	€
1 blister pack	Pack of 6	Price per pack
1 pouch	Pouch of 10	Price per pouch
12 items	Pouch of 12	Price per item
1 pack	Pack of 30	Price per pack
40 items	Pack of 40	Price per item
1 box	Box of 5	Price per box
8 items	Box of 8	Price per item
1 display	Display of 10	Price per display
6 items	6 / Display	Price per item

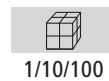

### Pack units

Possible pack units for 1 OU.



### Pallet

No. of order units (OU) per pallet.



### Forwarder

All items marked with this icon must be shipped by freight carrier due to their scale/size or weight. This means that additional, separate freight costs are required! Optimise freight costs by ordering entire pallet units.

↑	↑	↑
<b>OU</b> <b>Order unit for retail</b> Always order a multiple of the number stated (e.g. OU = 12 items, order in lots of 12).	<b>Items/pack unit</b> <b>No. of items per order unit/pack unit</b>	<b>Price/€</b> <b>Price per OU</b> If the OU column is empty or missing, the price is per item. All prices provided are the manufacturer's recommended retail prices and are inclusive of VAT.



### Animal types

You will find animal icons on many products. These indicate usage for certain animal types.

## Better product presentation with videos, 360° photo player and downloads



### Product videos

You can now find out even more about our products in appealing, informative and attractive product videos.

All features and functions are shown live in action. We also present areas of use that some people may previously have been unaware of. Explanatory and installation videos facilitate operation and clarify features. In this way, we are trying to answer questions on products in advance and also provide you with real added value.



### 360° photo player

We are also offering complete 360° views of selected products in addition to our high-resolution professional product photos.

This gives you the option of viewing the product in advance from all sides and in extreme close-up, in high resolution and in sharp focus. Although you still cannot touch it, you can get a much better, more realistic feel for the product.



### Product images

While we can only show you basic illustrations of a product in our catalogue, we can also provide you with digital copies of further photos showing detailed views and usage, for example.

The warranty information in this catalogue is based on the general warranty conditions of AKO-Agrartechnik GmbH & Co. KG. The current version of the general warranty conditions can be found at: <https://www.ako-agrar.com/guarantee>. These can also be sent electronically or by post on request.



# The product ranges from AKO

Alongside our fence devices, we have now also divided our accessories range into three familiar product collections - PREMIUM, EXPERT and CLASSIC - in order to make it easier for you to choose the most suitable product:



## Premium:

Products of the perfectly coordinated Premium line feature the highest quality and a particularly long service life: our articles with Premium character each stand out due to a clear added value in function and material quality and are thus ideally suited for professional use in demanding pasture fencing systems, where they significantly reduce the amount of maintenance required.



## Expert:

A range of functional and long-lasting products that have proven their capabilities over many years in a wide range of applications. Flexibility and efficiency are this product range's strengths.



## Classic:

A range of products with tried-and-tested and robust properties that offers particularly good value for money. These products are suitable for all purposes in professional as well as hobby applications. The CLASSIC products meet the expectations of animal keepers who want solid and functional equipment.



## Fence advice

---

# Customer Support Line +49 8086 933-577



Our fence experts will be happy to help you with all your fencing problems. Is your electric fence unit flashing red and you cannot tell why? Is your fence suddenly without power and you cannot find the fault? We will find the solution together!

For simple queries, it is best to send an e-mail to [weidezaun@kerbl.com](mailto:weidezaun@kerbl.com). If you have a more complex problem, please feel free to contact us by phone! Our professional fence construction partner is just what you need for the proper planning and construction of your complete fence system.

## My Manual

---

# www.my-manual.eu

You can download the current user guide and declarations of conformity for your electric fence unit at any time from [www.my-manual.eu](http://www.my-manual.eu).

You can find the sticker with the item number of your device directly on your device.



Here you'll find:

### Manuals

Device-specific information

### Declarations of conformity

Our declaration of which EU directives and standards the device conforms to.

### General instructions

General information on setting up a fence system.

Please pay close attention to the version number when entering the item number of your device.



Pasture fence configuration is no gamble with AKO!

[www.fenceconfigurator.com](http://www.fenceconfigurator.com)



Do you need advice on the construction of your fencing system?

The pasture fence calculator will help you!

**Tierart**  
Pferd groß (Zaunhöhe min. 140 cm über Grund)

**Umfang**  
Zaun und Gerät

**Zaunart**  
Permanenzzaun

**Bewuchs**  
Mittel

**Zaunkonfiguration**  
Band 20mm und Seil, Holzpfahl, verschiedene Leitermaterialien zu 3 Höhen (2 Kombinationen)

**With just a few questions, the pasture fence calculator will create a customised material list for your requirements!**

Simple questions guide you through the most important points, such as:

- Animal species
- Circumference
- Fence type
- Vegetation

**Wählen Sie die Tierart**

Für/Eigen welche Tierart suchst du eine Zaunlösung?

Wähle ein Tier aus:

**Mit welchem Bewuchs ist in deiner Zaunanlage zu rechnen?**

Der Bewuchs am Zaun hat einen wesentlichen Einfluss auf die max. Zaunlänge eines Weidezaunsystems. Je höher der Bewuchs am Zaun ist, desto geringer wird die Zaunlänge, wodurch die max. Zaunlänge reduziert wird. Grundsätzlich ist es von Vorteil, den Bewuchs an der Zaunanlage durch regelmäßigen Ausmähen so gering als möglich zu halten. Welche der Zaunarten werden durch den Bewuchs der Zaunanlage am besten auf und warum? Bitte auswählen.

Kleiner, Mittler, Hoch

**Zaundaten**

Schreib hier deine Zaundaten direkt in die Eingabefelder oder nutze den Kartendienst

Länge: 1200

Ecken: 7

Tore freihand: 3

Tore am Eck: 1

KARTENDIENST

**Determine your fence data**

Use the integrated online map service to calculate the length of your fence.

**Exact dimensions are not known?**

This problem is also easy to solve by simply marking your pasture area online.

Once all parts of your fence have been defined, you will receive a list of materials that you can output as a PDF or Excel file. Order and purchase the desired items from the material list from your AKO dealer!

**Wähle die Fläche aus, in der dein Zaun gebaut werden soll**

Maße in m (1:1000) oder in km (1:10000) sind möglich. Die Fläche muss durch Punkte im Uhrzeigersinn definiert werden. Die Punkte müssen durch Linien verbunden sein. Die Fläche muss ein geschlossenes Polygon sein.

Try out our new pasture fence calculator for yourself!



# B450



- 9 V battery units with effective output
- visual check for fence insulation and battery voltage
- easy handling
- allows for optional operation with 12 V battery – with deep discharge protection
- easy to transport
- 6 daylight bright LEDs (bar graph display) for fence and battery monitoring
- includes robust carry handle
- microprocessor controlled
- with large High/Low/Off (magnetic) rotary switch
- robust, impact-resistant, UV-resistant and weather-resistant housing thanks to the use of high-quality plastics
- corresponds to applicable EU safety standards



Made in Germany

5-year warranty

multi-colour LED bar graph display for output voltage and battery control

LED bar graph for fence and battery checks

Large High/Low/Off (magnetic) rotary switch



includes high energy 9 volt battery, 75 Ah (44220)

0,45 Joule



## Compact Power B450

- highly effective 9/12 Volt fence device for mobile use
- for fences with low vegetation
- ideal for horses, cattle, pigs, poultry, dogs, cats and herons
- Level 1(Eco): 0.2 Joule output
- with High/Low/Off switch
- 5-year warranty



Ref. no.			€
372775	1	90	

Included in delivery:

- 1 x fence unit,
- 1 x fence / ground connector cable,
- 1 x installation ground rod,
- 1 x warning sign,
- 1 x 9 Volt, 75 Ah battery (44220)



Model	Ref. no.										
B450	372775	0.45 J	0.35 J	10,500 V	9,600 V	3,300 V	10 km	5 km	3 km	1	46 mA



# N70

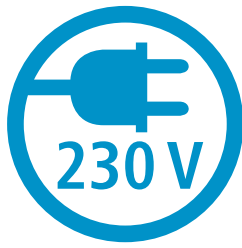

- extremely powerful 230 volt power supply
- for very strong animals and for very long fences- even with vegetative growth
- bright LED displays allow for easy visual monitoring of the current fence and device status at a glance
- device automatically adapts to the fence status, ensures highest protection certainty and makes your work easier by reducing vegetation growth to a certain degree
- robust, impact-resistant, UV-resistant and weather-resistant housing thanks to the use of high-quality plastics
- microprocessor controlled
- integrated hanging device for wall mounting
- corresponds to applicable EU safety standards

PROMO

%



Promotional device with excellent value for money

Made in Germany



5-year warranty



Multi-colour LED Bar Graph Display for Monitoring Fence and Earth Voltage



7,0 Joule



## Power Profi N 70

- very effective 230 volt power supply
- can be used with medium to heavy vegetative growth
- designed for robust animal species such as cattle, sheep, horses, and for deterring wild boars and wolves
- our all-round device for all types of animal
- 5-year warranty



Ref. no.			€
372777	1	108	

Model	Ref. no.														
N 70	372777	7 J	5 J	0.55 J	10,000 V	9,200 V	6,800 V	140 km	45 km	9 km	4.5 km	20	3	2	7 W

PROMO

PROMO



- Especially suitable for horse paddocks! End-to-end electrical contact.
- integrated retraction brake ensures controlled retraction of the conductor material and prevents injuries and damage
- patented



Experience the difference compared to conventional gate systems thanks to the braking function!

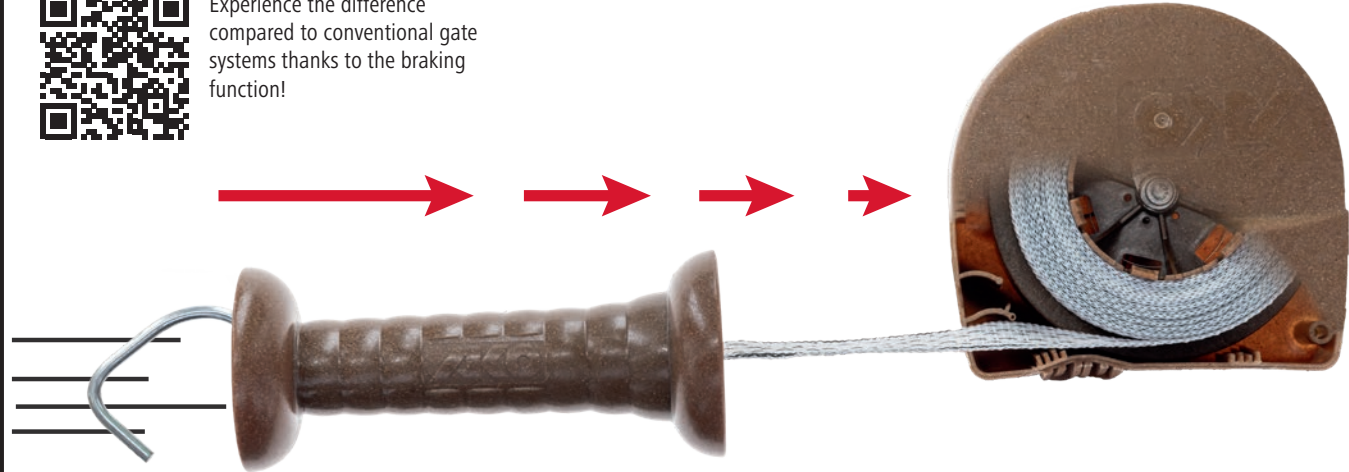



## Gate Set Premium FLEXIGATE green

Innovative technology, sustainable material and a new look - our new flexible gate system for paddock entrances up to 6 m wide

- housing and gate handle made of sustainable bio-based plastic - from 100 % renewable raw materials
- wood look thanks to small natural wood chips in the bio-plastic
- robust housing in a compact and modern design
- connection cable included in the scope of delivery enables ideal contacting and continuous electrification of the gate
- easy and quick mounting on the post by means of enclosed wood screws
- high-quality conductor material with our proven TriCond wires ensures maximum conductivity throughout - available with 40 mm wide tape or 6 mm rope
- The orientation of the 40 mm wide tape can be rotated by 90 degrees in the gate handle and can thus be individually adapted to the hanging direction of the gate handle -> wide tape is always upright and can thus be perceived better
- extendable up to 6 m in length
- can be mounted on both sides (opening to the left or right)



Made in Germany

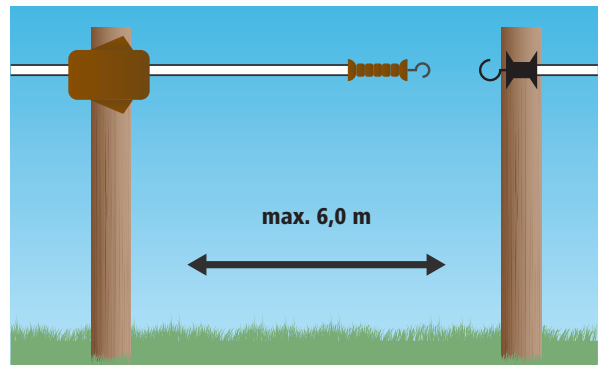

Included in delivery: 1 x FLEXIGATE green, 1 x connection cable (40 cm) with ribbon or cable connector for optional electrification, 2 x wood screws for mounting on the post

Ref. no.	Description	Colour		€
442398	with 40 mm tape	brown	1	
442399	with 6 mm rope	brown	1	

## Ring insulator with continuous support incl. screw-in screwdriver in robust stable/construction bucket

So that you always have our top-selling insulator to hand - supplied in a jumbo bucket that can be reused as a practical construction or stable bucket.

- Free screwdriver!
- with wide wire support
- Material: Plastic
- with wood thread
- with continuous galvanised support  $\varnothing$  5,3 mm
- Suitable for: Poly wire, Rope, tape up to 10 mm



supplied in a durable, robust 12-litre stable/construction bucket with transparent lid and free screwdriver!

Included in delivery:  
1 x stable/construction bucket,  
1 x transparent lid,  
250 x ring insulator,  
1 x screwdriver

Ref. no.	MOQ	Pieces / unit		€
44314/2503E	1 bucket	250 / bucket	1	



# PlatinumLine

Made in Germany



## Conductor wires

Many and thick copper or stainless steel conductors for maximum conductivity and thus the best possible shock effect in the event of animal contact.

## Resistance

Particularly low resistance means maximum guarding safety and electrical voltage along the entire length of the fence, even for extremely long fences.

## max. fence length

## Break load

Reinforced outer edges and extra strong plastic strands for more robustness and a particularly long service life!

5 year UV stability warranty



## Tape PlatinumLine

The PlatinumLine fence tape with extra-thick monofilament threads, reinforced outer edges and tin-plated copper wires offers maximum protection and is particularly durable.

- the ideal combination of the best conductivity and increased breaking load combined in one conductor material
- extra-thick monofilaments and reinforced outer edges ensure excellent breaking strength and longevity
- maximum conductivity and protection thanks to the use of thick, galvanised copper wires



- 2 x 200 m length in twin pack
- practical double pack with TOP price/performance ratio



Ref. no.	Length	Width	Colour	max. recommended fence length	Resistance	Number of conductors	Stainless Steel Ladder	Tin-plated copper conductor	Break load		€
442828	400 m	12.5 mm	white / blue	13 km	0.16 Ω/m	5	3 x 0,2 mm	2 x 0,25 mm	80 kg	1 120	



# PlatinumLine

Made in Germany



PROMO

%

PROMO

## Conductor wires

Many and thick copper or stainless steel conductors for maximum conductivity.

## Resistance

Particularly low resistance means maximum guarding safety and electrical voltage along the entire length of the fence, even for extremely long fences.

## max. fence length

## Break load

Unique braiding for maximum stability and durability with improved elasticity.

## Cross braiding

Best possible shock effect in the event of animal contact thanks to conductive wires running along the entire surface.

5 year UV stability warranty



## Poly Wire PlatinumLine

Conductive, robust and safe - our polywire combines excellent conductivity with an increased breaking load. With its unique braiding, continuous surface conductor wires and extra-thick copper wires, it offers optimum contact and safety for your animals.

- the ideal combination of the best conductivity and increased breaking load combined in one conductor material
- unique braiding for maximum stability and durability with improved elasticity
- the conductor wires running continuously on the surface guarantee optimum contact at all times
- extra-thick copper wires ensure high conductivity and protection



- 2 x 300 m length in twin pack
- practical double pack with TOP price/performance ratio



woven and therefore extremely robust and resilient

Ref. no.	Length	Colour	max. recommended fence length	Resistance	Number of conductors	Stainless Steel Ladder	Tin-plated copper conductor	Break load		€
442829	600 m	white / blue	30 km	0.06 Ω/m	10	6 x 0,2 mm	4 x 0,25 mm	120 kg	1 120	

PROMO

# This is how an electric fence system works!

## An electric fence system consists of:

- A) An electric fence unit that generates regular electric pulses.
  - B) One or more wires that transport electricity (although these do not necessarily have to form a closed loop).
  - C) Insulators that isolate the electricity from earth.
  - D) Permanent or mobile posts that can be used as required.
  - E) The earth of the electric fence unit, which should be buried as deep as possible in damp soil.
- If the animal touches the wire, an electric circuit is closed, i.e. the electric current flows through the animal and the earth back to the unit. The animal consequently receives an unpleasant, though harmless, electric shock and retreats. An electric fence system of this kind is used successfully to pen animals in and also to keep other animals out.

Permanent fence with 230-Volt supply voltage

Mobile fence with 9 Volt or 12 Volt supply voltage

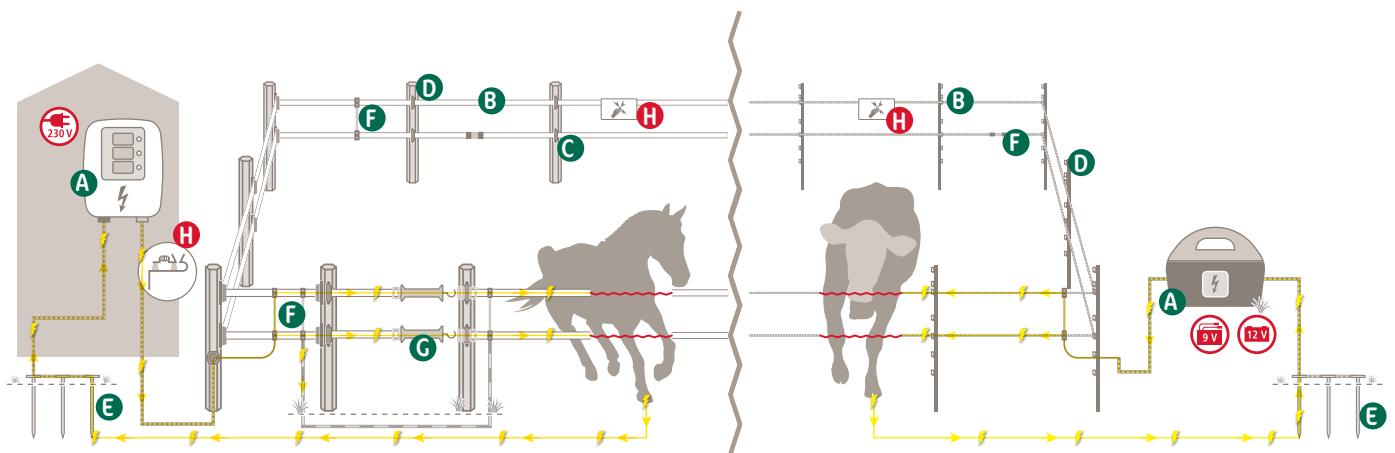

Make sure there are at least 2500 V at every point of the fence.

You can find much more information on our website too!



- A Electric fence device
- B Conductor material
- C Insulators
- D Posts
- E Earthing
- F Connections
- G Gate system
- H Safety components





# How many wires at which height?

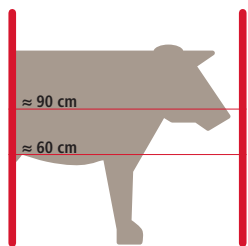

Electric Fence for Dairy Cows  
Recommendation: 10 mm tape, polywire

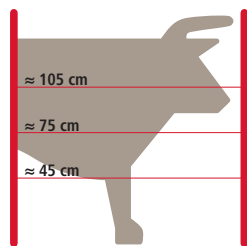

Electric Fence for Bulls, Cattle and Suckler Cows with Calves  
Recommendation: 10 mm tape, polywire

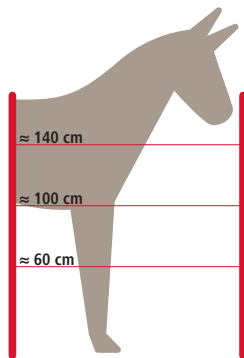

Electric Fence for Big Horses  
Recommendation: rope or tape up to 40 mm

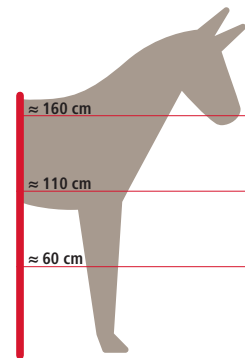

Electric Fence for Jumping Horses  
Recommendation: Rope, Wide Tape up to 40 mm

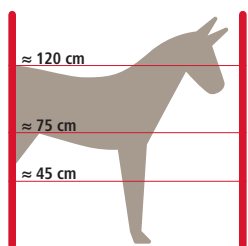

Electric Fence for Small Horses  
Recommendation: 10 mm tape, rope

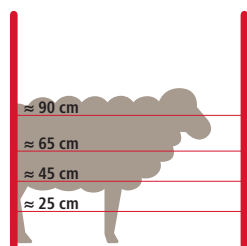

Electric fence for sheep  
Recommendation: sheep netting, wire, polywire

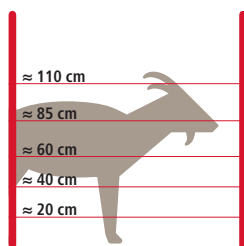

Electric Fences for Goats  
Recommendation: electric wire, polywire

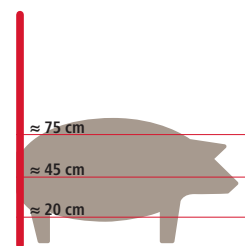

Electric Fences for Pigs  
Recommendation: 10 mm tape, polywire

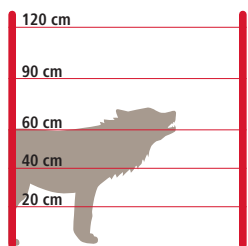

Wolf deterrence  
Recommendation: wolf net (sheep farming), wire, herd guard tape

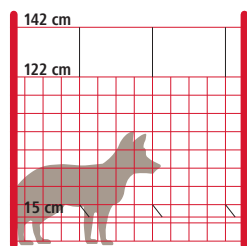

Defence against foxes  
Recommendation: electrifiable poultry net, WolfStop

When keeping domestic pigs, an exterior, wild animal density fence (metal hinge joint fencing) is required in addition to the interior electric fence!

The specifications like fence heights are only approximate and need to be adapted to the animal species you wish to fence in. Please observe regional regulations if applicable!

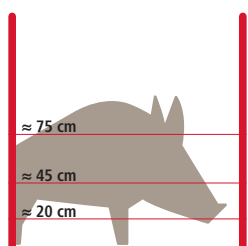

Deterring Wild Boars  
Recommendation: Wild animal deterrent net, 10 mm tape, polywire

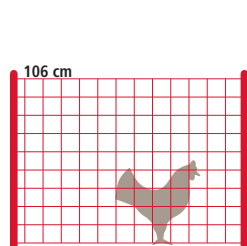

Electric Fences for Hens  
Recommendation: poultry netting, polywire

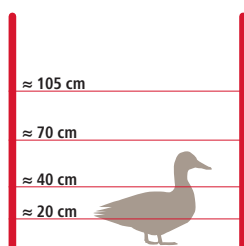

Electric Fences for Geese  
Recommendation: poultry netting, tape, polywire

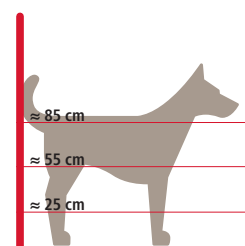

Electric Fences for Tall Dogs  
Recommendation: Hobbyset, polywire

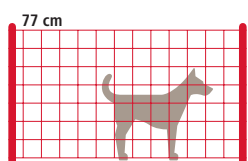

Electric Fences for Small Dogs  
Recommendation: Hobbyset, polywire

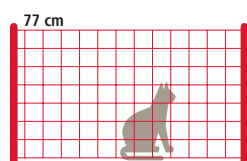

Electric Fences for Cats  
Recommendation: Hobbyset, polywire

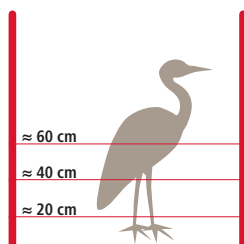

Electric Fence to deter Herons  
Recommendation: Hobbyset, polywire

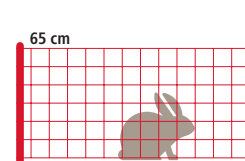

Electric Fence for Rabbits  
Recommendation: rabbit netting, polywire

# Explanation of technical terms



## Earth

The earth is an important part of the power circuit. To ensure the current can flow from the earth back to the unit unhindered, the earth rod must have the best possible contact with the soil (dry earth barely conducts electricity). Therefore, when inserting the earth rod, choose damp places where possible, or choose earth rods that are sufficiently long to reach deeper, damp layers of earth.



## Shock voltage and pulse energy

The peak of an electric pulse generated by an electric fence unit is known as shock voltage. A high voltage is needed to create a conductive 'channel' between the fence wire and the animal's body. The minimum voltage is around 2500 V. For animals with a thick coat, we recommend 5000 V as the minimum voltage. The current (pulse energy) can now flow through this 'channel'. Therefore, the shock effect depends on the amount of pulse energy (voltage itself does not hurt!). The more insensitive the animal is, the greater the energy needed to secure or scare it. The demand for pulse energy also increases with the length of the fence and its load (e.g. vegetation).



## Fence Resistance

as well as sufficient impulse energy, you also need highly conductive fence material to achieve the maximum shock possible and to make sure that there is minimum loss in the energy delivered to the animal, and no energy fade beforehand. The conductor resistance is a measure for assessing the fence material. It is specified in Ohm/meter. The smaller this value, the better the material conducts. The longer the fence, the better must be the conductivity of the chosen material. The best materials have a resistance  $< 1 \Omega/m$ ; poorer materials exceed  $4 \Omega/m$ . Investigations have shown that, in addition to very good conductivity, which is achieved mostly by copper wire, long-term durability (e.g. by means of stainless steel wires with poor conductivity) is decisive for the security of an electric fence. Here, our proven TriCOND material provides the necessary compromise, and is renowned for outstanding conductivity combined with extended durability.



## What kilometre figures should you base your decision on?

Kilometre figures are often highly theoretical values that are based on the best possible conditions (wire conductivity, connections, insulation status, ground conditions, earthing) in the fence system. These conditions change constantly, however, due to the influences of weather. It is therefore important to achieve the minimum protective voltage of 2,500 (5000 Volt in the case of very robust animals and dry soils) at each point of the fence system in all conditions.

## How powerful does your fence device need to be?

This forms the basis for choosing the device family!  
 Select your fence length along the X-axis and your animal species or vegetation along the Y-axis.  
 You can see the minimum joule power required and the possible device families at the intersection.

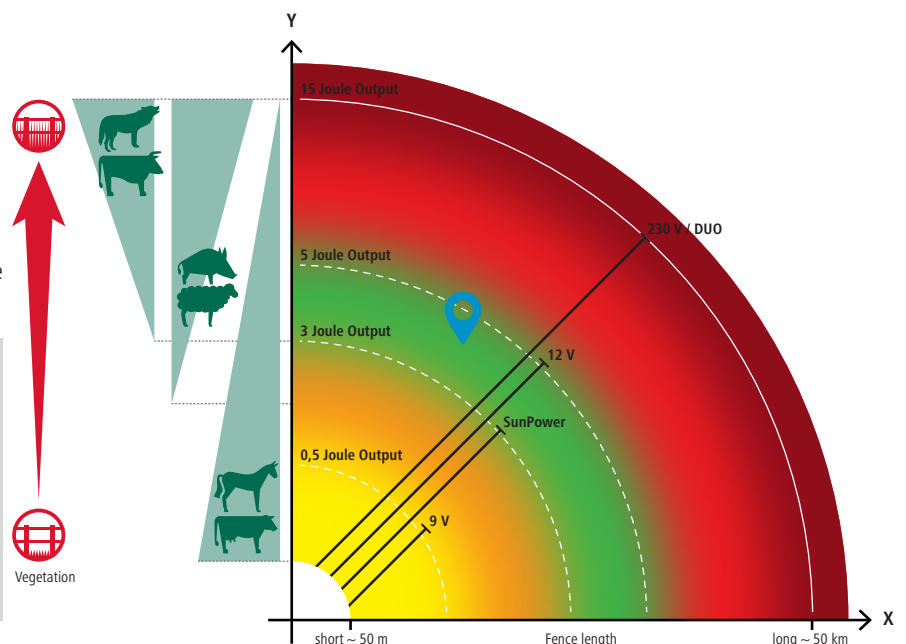
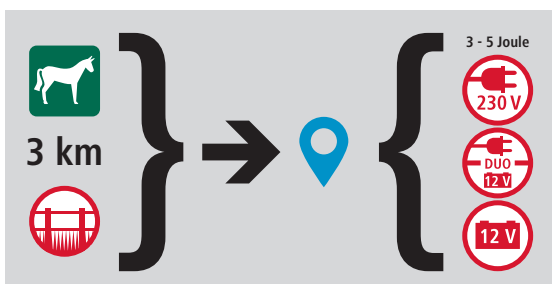



# Choosing your electric fence unit



## 230 V power energisers – the **FIRST CHOICE** if a mains socket is available.

These units have an unlimited protection period. They are available in all of the necessary power classes and are the best means of delivering the energy required (0.5 Joule up to 14.5 Joule output) on long fences or fences with vegetation, or for very robust animals. The higher energies of course do not harm the animals. All fence devices comply with applicable safety standards. If mobile use is intended, e.g. at tournaments, on trail or distance rides or simply on frequently changing pastures where there is no 230 Volt power supply available, you must resort to a battery-powered unit. For fences with heavier vegetative growth, 9 Volt compact solar units are inadequate and 12 Volt units must be used.



## 12 V battery units – strong performance even on fences with heavier vegetative growth.

12 V battery units are ideal for very robust animals, long fences and/or fences with vegetation if no 230 V connection is available. The discharge energy is comparable with mains devices (0.5 Joules to around 15 Joules output). Rechargeable 12 V wet batteries are used as the power source, which must be recharged every 2 – 4 weeks or so depending on the type of device, power requirements and battery type. Solar modules, which convert solar energy into electricity and therefore constantly top up the 12 V battery, are a good add-on.



## 12/230 V DUO units – maximum flexibility combined with powerful output energies!

Units of this type combine the unlimited security time of the 230 V units with the mobility of powerful 12 V units. A 12 V cable and 230 V adapter are included.



## 9 V dry battery units – the ideal units for smaller fences and paddocks!

9 V battery units are suitable for shorter fence lengths without vegetation. They are highly mobile and significantly lighter than 12 V units. The 9 V battery runs for a few months and can even cover an entire pasture season depending on the operating time, battery type and size (expressed in Ah – the more Ah (ampere hours), the longer it runs for). Once discharged, it cannot be recharged. 9 V units (even if these can also be operated with 12 V batteries) are weaker than 12 V units. 9 V units in this instance typically deliver approx. 0.15 to 0.35 joules. High-impact 9 V units can deliver up to 0.55 joules.



## Compact Solar Units

Compact solar units from the CLASSIC range – similar to 9 volt devices for smaller fences without vegetative growth, or: AKO SunPOWER from the PREMIUM and EXPERT range = extremely powerful, mobile compact solar units. Crystalline solar modules in combination with our high-performance solar fence devices are able to supply power to fences which are many kilometres in length. Even after a whole week without direct sunlight, these fence devices still have sufficient power to supply your fence with sufficient current. These special devices are outstandingly suited for fencing relatively large areas. Sufficient voltage is supplied everywhere along the fence, without the requirement for a socket anywhere nearby!









The 12-Volt AGM battery is integrated, and is constantly charged via the solar module built into the housing. If the battery has to be topped up, it can be recharged using the 230 volt mains adapter supplied.



### Expert tip:











the longer the fence, the more robust the animal or the thicker the vegetation, the more discharge energy in joules is required. If a socket is available, you should always use a 230-Volt device for the best protection!

# Explanation of symbols

Symbols	Short description	Unit	detailed description
	Grounding	Quantity	In order to enable electricity to flow freely from the ground to the device, optimal contact should be ensured between the earthing rod and soil (dry soil is a poor electricity conductor). The earthing rod (which must be galvanised) should therefore be driven into a damp area, or the length of the earthing rod should be measured to ensure that deeper, damper soil layers are reached. The recommended number of earthing rods depends on the power class of the device.
	Resistance	Ohms	The following resistance can be identified in a fence system: Earthing resistance => should be as low as possible Conductive material resistance => displayed in Ohm/metres. The smaller this value, the better the material's conductivity. The conductivity requirements of the material used increase with the length of the fence. The best materials have a resistance smaller than 0.25 Ω/m. Isolator resistance => should be as high as possible
	Max. Voltage	Volts	This voltage is reached with a low fence charge.
	Voltage in Open Circuit	Volts	Voltage when no fence system is connected to the electric fencer device.
	Voltage at 500 Ohms	Volts	Voltage at a fence charge of 500 Ohm.
	Stored Energy	Joules	Energy absorbed by device. The electric fencer efficiency ratio yields the relevant discharge energy value for the user.
	Max. Output	Joules	Maximum energy transmitted from the device to the fence system. This pulse is also identified as shock strength.
	Output Energy	Joules	Minimum energy transmitted from the device to the fence system. This can be reached through a fence output with reduced power or through selecting the lowest power level of an electric fencer device.
	Foal Protection Switch		Users can activate the foal protection switch as needed. If an animal should get caught in the fence, a considerably prolonged pulse interval (up to 60 sec.) does not excessively stress the animal and also increases the likelihood of it freeing itself. In parallel, the device emits an acoustic and visual alarm.



# Explanation of symbols

Symbols	Short description		detailed description
	Theor. Fence Length VDE (2000 V)		With fence lengths in accordance with VDE, only a theoretical value is given, which, as a result of various influences (fence flora, weather and soil conditions) cannot be reached in practice.
	Max. Fence Length with Varying Vegetative Growth		Flora on the fence has a considerable influence on the max. fence length for an electric fence device. The more vegetation on the fence, the higher the fence charge will be, thus reducing the max. fence length. The fence length indications refer to highly conductive wire material and connectors, good isolators and an optimal earthing system!
	Approx. Number of Electrifiable Nets	Quantity	For 230 V and 12 V devices, the maximum number of 50 m lines to be used is given.
	Voltage Supply 230 V	Volts	Devices with power supplies (230 V) have an unlimited protection duration. These are available in all necessary power classes and are the best solution for power provision to long fences. Even in the event of heavy vegetation, sufficient energy is supplied to the fence.
	Voltage Supply 12 V or 12 V Solar	Volts	12 Volt battery chargers are the ideal solution for long fences or fences with considerable amounts of vegetation in the event that no power supply is available. The discharge energy can be compared to the power supply units. Rechargeable 12 Volt wet cells are used as a source of power. A useful addition are solar modules, which are offered in a range of power classes and transform solar energy into electricity.
			
	Voltage Supply 230 V or 12 V	Volts	This type of device combines the unlimited protection duration of the 230 Volt devices with the mobility of the powerful 12 Volt devices.
	Voltage Supply 9 V	Volts	The 9 Volt dry battery devices are characterised by their excellent mobility, coupled with a long battery life. They are ideal for short fences with moderate vegetation if no power supply is available.
	Voltage Supply 2 x 1.5 V	Volts	3 Volt devices are mobile and easy to handle, and are suitable for fences without vegetation, such as in gardens or horse-training paddocks.
	Power Consumption	mA	The duration of the battery life can be calculated from the energy consumption along with the capacity of the battery.  Current consumption values are measured at 13 and 9 Volt and can rise as the battery voltage drops.
	Safety standard for devices from over 5 Joules to max. 15 Joules of discharge energy:		<ul style="list-style-type: none"> <li>delayed shock strength adjustment makes touching the fence safer for people and animals</li> <li>an alarm function continuously monitors the fence, triggering an alarm and slowing the pulse sequence if the fence is touched for a longer period</li> </ul>



# The fence device check

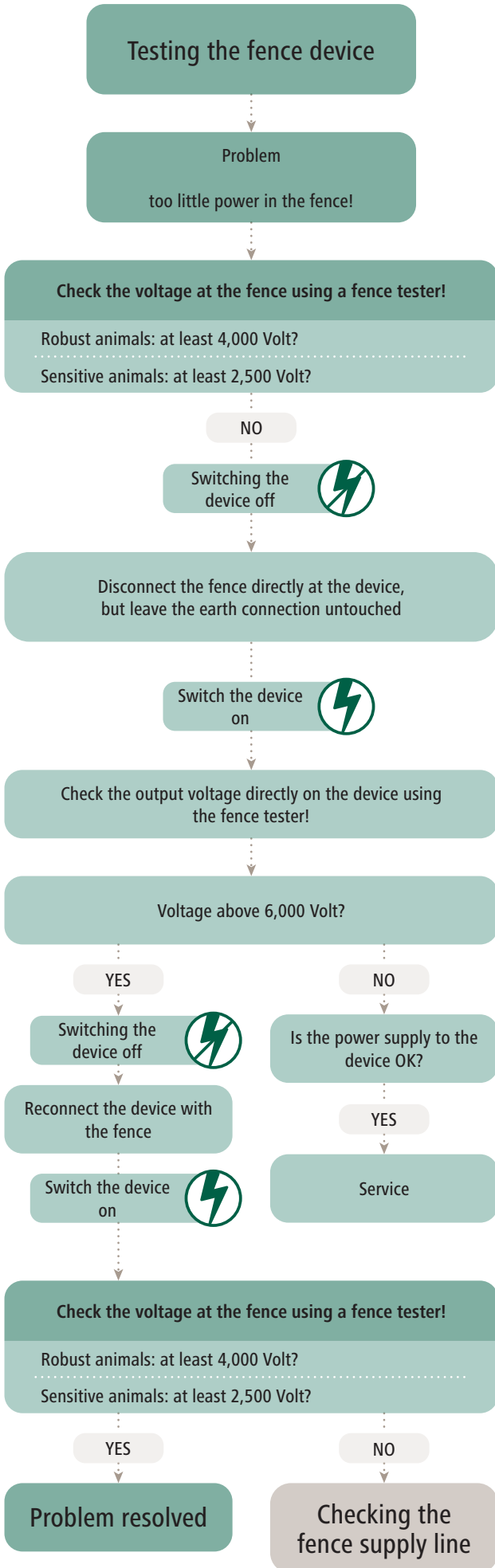

## Tip 1

1. Remove the knurled nuts from the earthing and fence output
2. Contact the earth output on the device using the fence tester's earthing rod
3. Contact the fence output on the device using the fence tester

## Tip 2

1. 9 volt battery: flashing red => battery is flat
2. 12 volt rechargeable battery: flashing red => battery is flat
3. 230 Volt mains power: LED not flashing => no power supply

- replace the 9 Volt battery
- charge the 12 Volt battery
- have the 230 Volt supply checked by a specialist



# The fence supply line & earthing check

## Checking the fence supply line

### Tip 3

1. Switch the device off
2. Disconnect the fence supply cable at the fence
3. Switch the device back on
4. Using the fence tester, measure the voltage at the end of the fence supply line cable



### Tip 4

1. **Underground fence supply line**  
The underground cable is faulty => use an underground cable resistant to high voltages
2. **Underground fence supply line**  
Check the fence supply line for diversions / interruptions (e.g. is the supply line contacting the building, e.g. ivy, guttering, shrubbery, etc.)?

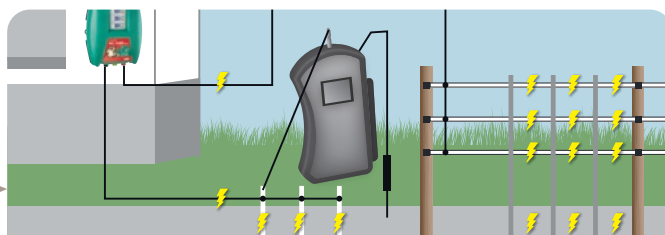

### Tip 5

- How do I measure voltage directly on the earthing rod?**
1. Short-circuit the fence wire approximately 10 m away from the device earthing using iron rods
  2. Check the voltage directly at the earthing rod using a digital voltmeter

### Tip 7

1. Vegetation on the fence => remove it!
2. Conductive material lying on the ground => tie / bind it up
3. Poor conductive material => replace with material that has good conductive properties (< 1 Ohm/m)
4. Conductive material is knotted => use stainless steel ties
5. Insulator breaks through => replace with new insulator
6. Broken metal conductor wires => replace conductive material
7. Improve conductivity => connect conductive material series with each other vertically at intervals of around 200 m

Check the fence voltage at the end of the fence supply line!

Voltage above 6,000 Volt?

YES

Switching the device off



Reconnect the fence supply line to the fence!

Switch the device on



Check the voltage at the fence using a fence tester!

Robust animals: at least 4,000 Volt?

Sensitive animals: at least 2,500 Volt?

YES

Problem resolved

NO

Checking the fence system & earthing

Check the earthing => Measure the voltage directly at the earthing spike!

Voltage directly at the earthing space above 1,000 Volt?

YES

Improve earthing

NO

Fault in the fence => Voltage loss at the fence

### Tip 6

1. Insert earthing rods to a depth of at least 1 m away from the building into damp soil
2. Insert multiple earthing rods at intervals of at least 3 m and connect them
3. Earthing rods must be made of non-rusting material, e.g. stainless steel, or must be galvanised

Check the voltage at the fence using a fence tester!

Robust animals: at least 4,000 Volt?

Sensitive animals: at least 2,500 Volt?

NO

YES

Everything OK



## New: 5 year warranty on all fence devices!

We are pleased to inform you that we are now offering an extended warranty of 5 years on all our electric fence devices. Trust in our quality and enjoy even more safety and reliability.



We have sorted our range based on various criteria, to help you choose the right unit:

### Premium

- digital displays for easily reading all the important information about the unit and fence system (except solar units)
- powerful units for the most exacting requirements – long fence systems and difficult conditions are no problem
- intelligent adaptation to the fence status, and alarm functions ensure maximum safety for humans and animals



Digital display

### Expert

- LED displays allow easy visual monitoring of the current fence and unit status at a glance
- Units with a high output for demanding fences
- good equipment means high flexibility in use



LED display

### Classic

- Check lights for the unit or fence
- effective output, designed for standard fences
- low-cost entry-level units with solid equipment



Check light

## Extended warranty against theft





























With the extended warranty against theft, you can insure your new AKO electric fence device for three years against theft if operated in Germany, Austria or Italy.

In the event of theft, we will send you - following registration of the theft with the police - a new device of the same or equivalent type. In the case of 9-Volt battery devices, the extended warranty against theft also covers the dry battery.

The premium form for concluding an insurance policy can be found in the service section of our website to download. Please also refer to this document for the provisions regarding the legally valid conclusion of the insurance and the claiming of insurance benefits.



Ref. no.	Model	Page											
	372815	NDi 15000 digital	31	10,200 V	14.5 J	100 km	22 km	12 km	•	•	•	•	•
	372810	NDi 10000 digital	31	10,200 V	10 J	80 km	18 km	9 km	•	•	•	•	•
	372936	XDi 15000 smart	24	11,200 V	15 J	80 km	22 km	14 km	•	•	•	•	•
	372931	XDi 10000 smart	24	11,200 V	10 J	65 km	18 km	10 km	•	•	•	•	•
	372954	S 4000 smart	26	11,900 V	4 J	35 km	9 km	4 km	•	•	•	•	•
	372955	S 3800	59	11,000 V	3.8 J	33 km	8 km	3.5 km	•	•	•	•	•
	372952	S 3000	59	11,000 V	3 J	30 km	6 km	3 km	•	•	•	•	•
	372953	S 2400 smart	26	11,800 V	2.4 J	20 km	5 km	2 km	•	•	•	•	•
	372951	S 1500	59	10,000 V	1.5 J	15 km	3 km	1.5 km	•	•	•	•	•
	372591	AD 5000 digital	47	11,000 V	4.6 J	38 km	14 km	5.5 km	•	•	•	•	•
	372291	AD 3000 digital	47	10,800 V	3 J	30 km	10 km	4 km	•	•	•	•	•
	372201	AD 2000 digital	47	10,500 V	2.1 J	20 km	8 km	3 km	•	•	•	•	•
	372036	BD 600 digital	71	11,700 V	0.55 J	10 km	7 km	2 km	•	•	•	•	•
	372034	BD 400 digital	71	11,400 V	0.4 J	8 km	5.5 km	1.7 km	•	•	•	•	•
	372033	BD 300 digital	71	11,000 V	0.3 J	6 km	4 km	1.5 km	•	•	•	•	•
	372811	Ni 10000	32	10,200 V	10 J	80 km	18 km	9 km	•	•	•	•	•
	372807	Ni 7000	33	10,000 V	7.5 J	70 km	15 km	7.5 km	•	•	•	•	•
	372777	N 70	33	10,000 V	5 J	45 km	9 km	4.5 km	•	•	•	•	•
	372804	N 5000	33	10,000 V	5 J	45 km	9 km	4.5 km	•	•	•	•	•
	372878	Xi 8000	39	11,200 V	8 J	50 km	17 km	7 km	•	•	•	•	•
	372879	Xi 8000 smart	25	11,200 V	8 J	50 km	17 km	7 km	•	•	•	•	•
	372876	X 6000 smart	25	12,000 V	5 J	40 km	11 km	6 km	•	•	•	•	•
	372869	X 1600 smart	25	11,000 V	1.6 J	12 km	2.5 km	1.5 km	•	•	•	•	•
	372950	S 1000	61	11,000 V	1 J	10 km	2.5 km	1 km	•	•	•	•	•
	372949	S 500	61	10,800 V	0.55 J	6 km	1.7 km	0.2 km	•	•	•	•	•
	372555	AN 6000	49	12,000 V	5 J	40 km	11 km	6 km	•	•	•	•	•
	372554	AN 4000	49	11,900 V	4 J	35 km	9 km	4 km	•	•	•	•	•
	372754	Savanne 3000	50	9,600 V	3 J	35 km	12 km	5 km	•	•	•	•	•
	372752	Savanne 2000	50	9,600 V	1.9 J	20 km	5 km	2 km	•	•	•	•	•
	372121	A 1200	51	10,700 V	1.4 J	10 km	5 km	1.5 km	•	•	•	•	•
	372030	B 500 plus	73	10,000 V	0.5 J	9 km	6 km	1.8 km	•	•	•	•	•
	372040	B 290	73	10,500 V	0.29 J	5 km	2 km		•	•	•	•	•
	372886	N 4800	35	9,000 V	4.8 J	30 km	8 km	4 km	•	•	•	•	•
	372883	N 3500	35	11,500 V	3.5 J	20 km	6 km	2.5 km	•	•	•	•	•
	372881	N 1200	35	12,500 V	1.2 J	10 km	2 km	1 km	•	•	•	•	•
	372080	N 700	77	8,800 V	0.55 J	7 km	1 km	0.3 km	•	•	•	•	•
	372874	X 4000	41	11,900 V	4 J	35 km	9 km	4 km	•	•	•	•	•
	372872	X 2500	41	9,600 V	2.5 J	18 km	4 km	1.7 km	•	•	•	•	•
	372871	X 1000	41	10,500 V	1 J	10 km	1.5 km	0.8 km	•	•	•	•	•
	372892	A 2000	53	9,600 V	2.5 J	25 km	5 km	2.5 km	•	•	•	•	•
	372055	AN 550	77	8,400 V	0.55 J	6 km	1 km		•	•	•	•	•
	372920	S 250	62	10,500 V	0.25 J	3 km	0.7 km		•	•	•	•	•
	372775	B450	75	10,500 V	0.35 J	5 km	3 km		•	•	•	•	•
	372026	B260 multi	75	9,800 V	0.26 J	4 km	1 km		•	•	•	•	•
	372018	B180	75	8,800 V	0.18 J	3 km	0.5 km		•	•	•	•	•
	372005	B 40	77	7,000 V	0.03 J	0.2 km			•	•	•	•	•





# Smart control

## You're in control!

Made in Germany



**up to date 24/7**

... constant monitoring via all smart devices



**FREE Kerbl Welt app**

... no follow-on costs at all for the functions provided by the app



**smart control via mobile phone or browser**

... Worldwide access to an unlimited number of smart devices in the app  
... unlimited number of users



**direct connection to the cloud/Internet**

... permanent, free mobile data transfer to the app





Download the app for free:



## App functions compared

### Fence device vs. Satellite

	SMART  ENERGIZER	 SmartSatellite
Power supply	12 / 230 V	2 x 1,5 V
ON/OFF switching function	✓	-
Power regulation	✓	-
Adjustable alarm threshold	✓	manually on the Satellite
up-to-date output voltage	✓	✓
up-to-date supply voltage	✓	✓
Alarm notifications	✓	✓
GPS tracking	✓	-
Data history	✓	✓
Mobile radio connection	LTE-M & NB-IoT	NB-IoT



## Functions of the AKO Smart App



### Kerbl dashboard / device summary

The dashboard is where all the smart devices assigned to the account are managed. The „+“ allows you to add any number of new devices at any time.



### Operating status

Real-time notification in the event of a change of fence voltage (e.g. falls below alarm threshold)



### Data history

The app shows the fence and battery voltage fluctuations for up to a week in the background.



### Messages

Summary of all push notifications and power changes.



### Settings

User-defined options depending on the smart device type.



### Supply voltage

Current supply voltage in Volts.



### Reception quality

Displays the current wireless connection.



### Switching function

The smart fence device can be switched ON and OFF regardless of location.



### GPS tracking

The smart fence device can be localised.





Functional system of the AKO smart world!

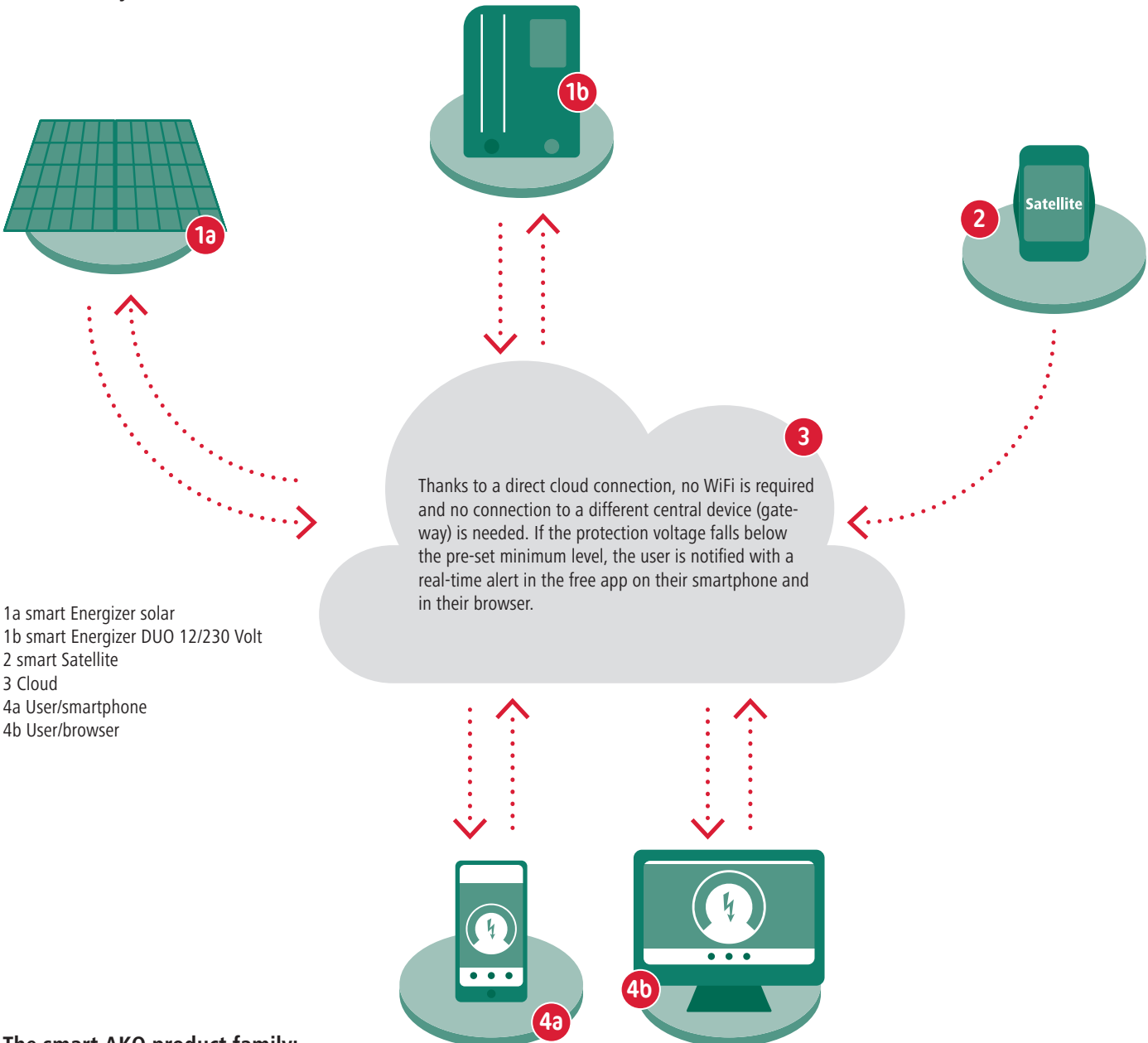

- 1a smart Energizer solar
- 1b smart Energizer DUO 12/230 Volt
- 2 smart Satellite
- 3 Cloud
- 4a User/smartphone
- 4b User/browser

The smart AKO product family:





# Smart Satellite

Made in Germany

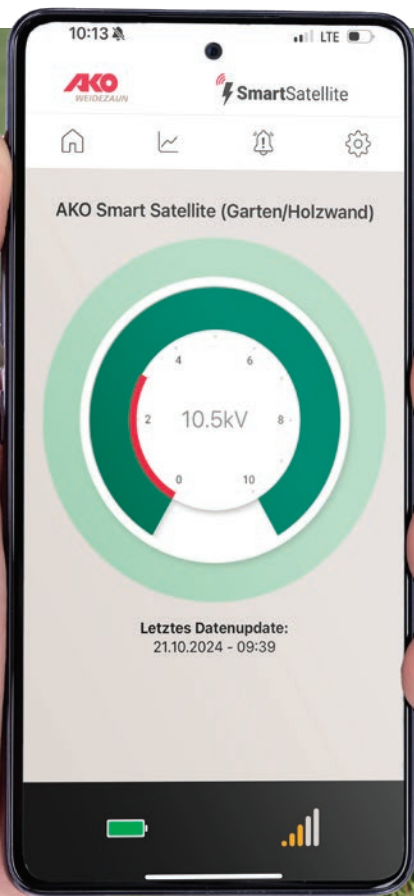

## AKO Smart Satellite

The Smart Satellite for connection to the Kerbl Welt app allows you to check the fence voltage at any time in real time and from any location.

- for mobile monitoring of the set minimum guard voltage on the fence
- Real-time alarm message in the app if the voltage falls below the minimum guard voltage preset directly on the satellite (selectable between 3 kV, 5 kV, 7 kV)
- thanks to the satellite's direct connection to the cloud, no WLAN is required, making it easy to monitor fence systems from any location

Utility model application registered!

Included in delivery:

- 1 x AKO Smart Satellite,
- 2 x AA batteries,
- 1 x earth cable with ground rod,
- 1 x fence connector cable,
- 1 x stainless steel clamp for connection directly to the conductor material

Ref. no.			€
441144	1/34	612	



## Power Station XDi

Made in Germany 



### Power Station XDi 15000 smart

- directly integrated cloud connection
- distance-neutral control (ON/OFF, GPS tracking) and monitoring of fence systems
- permanently free mobile data transfer to the app
- if the protection voltage falls below the pre-set minimum level, the user is notified with a real-time alert in the free app on their smartphone
- ultra powerful 12 / 230 Volt DUO unit
- for long fences with heavy vegetation
- for very robust animals such as bulls, sheep and for keeping wild boar and wolves at bay
- 5-year warranty

recommended solar module: 375999 (100 W), connection directly to the 12-Volt battery, optionally with ground anchor 442386 or fixing set 442386 for metal box

Digital display and multi-colour bar graph display

Included in delivery:

- 1 x fence unit,
- 1 x 230 volt power pack (371042),
- 1 x 12-Volt connection cable (E268739),
- 1 x ground connector cable,
- 1 x fence connector cable,
- 1 x reference connection cable,
- 1 x warning sign

New product 

20,0 Joule



Ref. no.			€
372936	1	72	



### Power Station XDi 10000 smart

- directly integrated cloud connection
- distance-neutral control (ON/OFF, GPS tracking) and monitoring of fence systems
- permanently free mobile data transfer to the app
- if the protection voltage falls below the pre-set minimum level, the user is notified with a real-time alert in the free app on their smartphone
- extremely powerful 12 / 230 Volt DUO unit
- for long fences with heavy vegetation
- for robust animals such as bulls, cattle, sheep and for keeping wild boar and wolves at bay
- 5-year warranty

recommended solar module: 375999 (100 W), connection directly to the 12-Volt battery, optionally with ground anchor 442386 or fixing set 442386 for metal box

Digital display and multi-colour bar graph display



Included in delivery:













- 1 x fence unit,
- 1 x 230 volt power pack (371042),
- 1 x 12-Volt connection cable (E268739),
- 1 x ground connector cable,
- 1 x fence connector cable,
- 1 x reference connection cable,
- 1 x warning sign

New product 

15,0 Joule



Ref. no.			€
372931	1	72	

Model	Ref. no.												
XDi 10000 smart	372931	15 J	10 J	11,200 V	10,200 V	8,700 V	250 km	65 km	18 km	10 km	35	6	410 - 760 mA
XDi 15000 smart	372936	20 J	15 J	11,200 V	10,200 V	8,900 V	350 km	80 km	22 km	14 km	40	6	410 - 1,170 mA

## Duo Power Xi & X

Made in Germany



12,0 Joule



### Duo Power Xi 8000 smart

- extremely powerful 12/230 Volt DUO fence device for mobile or stationary use
- can be used even with heavy vegetation
- our all-round device – ideal for horses, bulls, sheep and for deterring wild boars and wolves
- directly integrated cloud connection
- distance-neutral control (ON/OFF, GPS tracking) and monitoring of fence systems by smartphone
- permanently free mobile data transfer to the app
- with High/Low/OFF switch for 2 different output powers
- 5-year warranty

recommended solar module: 375999 (100 W), connection directly to the 12-Volt battery, optionally with ground anchor 442386 or fixing set 442386 for metal box

multi-colour LED bar graph display for output voltage and battery control

Included in delivery:

- 1 x fence unit,
- 1 x 230 volt power pack (371030),
- 1 x 12-Volt connection cable (E268739),
- 1 x fence / ground connector cable,
- 1 x warning sign

Ref. no.			€
372879	1	72	

7,5 Joule



### Duo Power X 6000 smart

- 12/230 Volt DUO fence device – maximum flexibility combined with powerful output energy
- ideal for horses, cattle, sheep, goats and deterring wild boars and wolves
- can be used with medium to heavy vegetative growth
- directly integrated cloud connection
- distance-neutral control (ON/OFF, GPS tracking) and monitoring of fence systems by smartphone
- permanently free mobile data transfer to the app
- with High/Low/OFF switch for 2 different output powers
- 5-year warranty

recommended solar module: 375559 (55 Watt), connection directly to the 12-Volt battery, optionally with ground anchor 442382 or fixing set 442386 for metal box

Included in delivery:

- 1 x fence unit,
- 1 x 230 volt power pack (371030),
- 1 x 12-Volt connection cable (E268739),
- 1 x fence / ground connector cable,
- 1 x warning sign

Ref. no.			€
372876	1	72	

### Duo Power X 1600 smart

- distance-neutral, mobile control (ON/OFF, GPS tracking) and monitoring of fence systems by smartphone
- 12 / 230 Volt DUO unit with efficient output
- with High/Low/OFF switch for 2 different output powers
- for normal fences without vegetation
- directly integrated cloud connection
- permanently free mobile data transfer to the app
- if the protection voltage falls below the pre-set minimum level, the user is notified with a real-time alert in the free app on their smartphone
- 5-year warranty

recommended solar module: 375151 (15 Watt), connection directly to the 12-Volt battery, mounting e.g. on a metal box

multi-colour LED bar graph display for output voltage and battery control

Included in delivery:

- 1 x fence unit,
- 1 x 230 volt power pack (371023),
- 1 x 12-Volt connection cable (E268739),
- 1 x ground connector cable,
- 1 x fence connector cable,
- 1 x warning sign

New product



2,2 Joule



Ref. no.			€
372869	1	88	



Model	Ref. no.													
X 1600 smart	372869	2.2 J	1.6 J	11,000 V	10,000 V	6,900 V	45 km	12 km	2.5 km	2.5 km	6	1		58 - 113 mA
X 6000 smart	372876	7.5 J	5 J	12,000 V	10,000 V	9,000 V	130 km	40 km	11 km	6 km	20	3		42 - 368 mA
Xi 8000 smart	372879	12 J	8 J	11,200 V	10,200 V	8,700 V	240 km	50 km	17 km	7 km	30	6	3	165 - 570 mA



## Sun Power S

Made in Germany



### Sun Power S 4000 smart

- our most powerful, smart all-round compact solar unit
- directly integrated cloud connection
- distance-neutral control (ON/OFF, GPS tracking) and monitoring of fence systems
- permanently free mobile data transfer to the app
- if the protection voltage falls below the pre-set minimum level, the user is notified with a real-time alert in the free app on their smartphone
- can be used with light to medium vegetation, universally for all standard fences
- ideal for horse and cattle paddocks, goats, sheep and wolf
- 5-year warranty

New product

NEW

5,5 Joule



multi-coloured LED bar graph display for output voltage and battery control plus solar operation LED (blue)

Included in delivery:

- 1 x solar fence device\*,
- 1 x AGM battery, 12 volt, 18 Ah (441125)\*,
- 1 x 12-Volt crystalline solar module, 40 Watt (not assembled) \*,
- 1 x 230-Volt power pack (371012),
- 1 x fence connector cable,
- 1 x ground connector cable,
- 1 x two-part ground/installation spear (442385),
- 1 x warning sign,

\* Warranty: solar fence device (5 year warranty),  
solar module (5 year performance warranty),  
12 volt battery (6 month warranty)

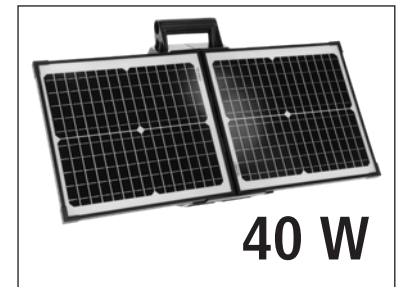

40 W

Ref. no.			€
372954	1	24	



### Sun Power S 2400 smart

- very powerful all-round compact solar unit
- can be used with light to medium vegetation, universally for all standard fences
- Ideal for horse and cattle paddocks, goats, sheep.
- directly integrated cloud connection
- distance-neutral control (ON/OFF, GPS tracking) and monitoring of fence systems by smartphone
- permanently free mobile data transfer to the app
- 5-year warranty

3,2 Joule



multi-colour LED bar graph display for output voltage and battery control  
Solar operation LED (blue)

Included in delivery:

- 1 x solar fence device\*,
- 1 x AGM battery, 12 volt, 18 Ah (441125)\*,
- 1 x 12-Volt crystalline solar module, 30 Watt (not assembled) \*,
- 1 x 230-Volt power pack (371012),
- 1 x fence connector cable,
- 1 x ground connector cable,
- 1 x two-part ground/installation spear (442385),
- 1 x warning sign,

\* Warranty: solar fence device (5 year warranty),  
solar module (5 year performance warranty),  
12 volt battery (6 month warranty)



30 W

Ref. no.			€
372953	1	24	

Model	Ref. no.												
S 2400 smart	372953	3.2 J	2.4 J	11,800 V	10,300 V	7,400 V	72 km	20 km	5 km	2 km	10	2	56 - 175 mA
S 4000 smart	372954	5.5 J	4 J	11,900 V	10,300 V	8,400 V	110 km	35 km	9 km	4 km	16	2	120 - 300 mA

# Solar-PowerStation smart

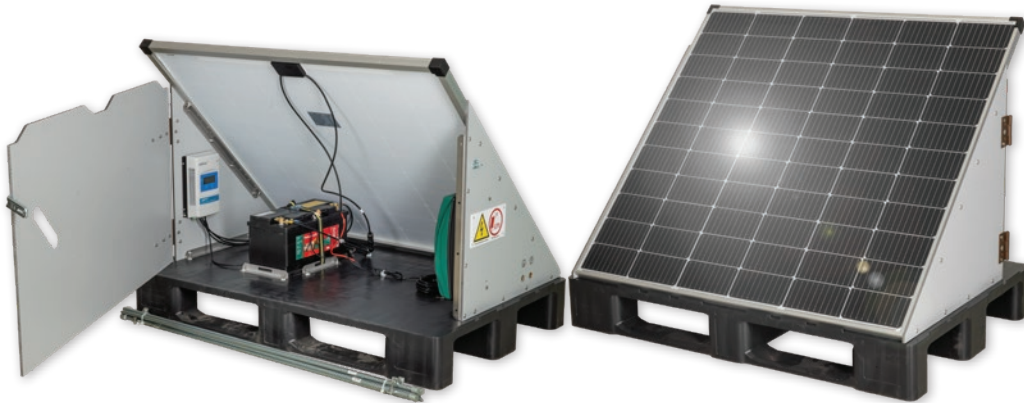

## AKO Solar-PowerStation smart

The solar station is ideal for large pastures without a power connection. Thanks to the practical app control, the system can be operated completely autonomously during the grazing season.

- ideal for large pastures without 230 Volt access
- autonomous operation during the grazing season from April to October
- for long fence lines
- directly integrated cloud connection
- with GPS localisation function
- distance-neutral control (ON/OFF, GPS tracking) and monitoring of fence systems by smartphone
- permanently free mobile data transfer to the app
- Delivery: fully assembled on a plastic Euro pallet (120 x 80 cm) - only needs to be connected to earth and fence.

Made in Germany



XXL: 20,0 J



XL: 12,0 J



Included in delivery:

- 1 x DUO Fence Device 12/230 Volt with Smart Function,
- 1 x 250 Watt solar module, 12 V battery (110 Ah) with charge controller,
- 6 x ground rods and earth or fence connection cable,
- 1 x high-quality, weather-resistant and robust HPL panel cladding,
- 1 x electrifiable closure option

Ref. no.	Description		€
441101	XL incl. smart fence device (12 Joule input), 1 battery	1	
441101-0	XL without fence device, incl. 1 battery	1	NEW
441103	XXL inkl. smartem Weidezaungerät (20 Joule Input), 2 Akkus	1	
441103-0	XXL without fence device, incl. 2 batteries	1	NEW

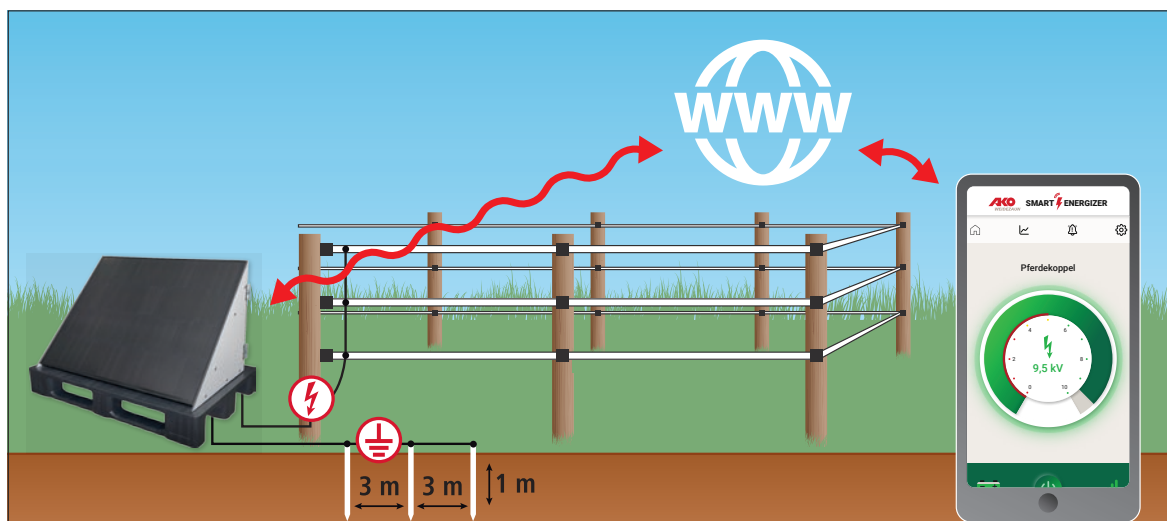







# 230 Volt Power Supplies

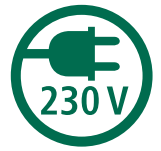

## AKO's power stations for the toughest fence requirements!

230 V power energisers provide security for an unlimited period. They are available in all the necessary power classes and are the best means of delivering the energy required (output 0.5 to 14.5 joules) on long fences or fences with vegetation, or for very robust animals. Animals and people are of course not harmed by this higher energy. All AKO units comply with applicable safety standards.

Made in Germany



## The advantages at a glance:

- Low energy costs
- Low maintenance
- High output
- Vegetation-resistant

## Recommended accessories:

(not included)



Underground cable,  $\varnothing$  1.6 mm item No. 44817, 44930, 44932, 44933

Connection cable (to earth / fence) NOT included in the scope of delivery!



Ground Rod with T-profile 1 m item no. 44615

Ground Rod with T-profile 2 m item no. 441369

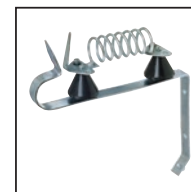

Lightning Choke item no. 44601



AKO Warning Sign item no. 446513



Digital Duo Voltmeter item No. 442328

# Power Profi NDi

Made in Germany 

5-year warranty 



- The smart 230 V power energiser line from AKO – extremely effective, for very robust animals and for very long fences even with vegetation!
- AKO NDi units automatically adapt to the fence status, ensuring the highest security and making your work easier by damaging vegetation growth to some degree
- Delayed shock strength adjustment makes touching the fence safer for people and animals
- the fence is constantly monitored by an alarm function, which triggers an alarm and slows the pulse sequence if the fence is touched for an extended period of time
- permanently illuminated, clearly visible digital displays and additional bright LED displays allow for easy visual monitoring of the current fence and device status at a glance
- robust, impact-resistant, UV-resistant and weather-resistant housing thanks to the use of high-quality plastics
- microprocessor controlled
- integrated hanging device for wall mounting
- corresponds to applicable EU safety standards



### Monitoring: Fence output voltage

Display of the output voltage in kV. Enables even the smallest changes to fence status to be detected.

### Monitoring: Earth voltage

Display of earth voltage in kV. The lower the displayed value, the better the earthing of the unit.

### Monitoring: energy consumption

Continuous display of energy consumption in %. The lower the reading, the less energy the device is consuming! (NDi 15000 & NDi 10000)

Bi-colour LEDs support the corresponding LCD display value.

**Flashing green** = the displayed value is OK  
**Flashing red** = the value does not meet minimum requirements. Fix the defect.

Fitted with two fence output terminals 'out'  
 Max.  
 Min.



Discover devices with smart functions in the „Smart products“ section!

from page 22

# 230 Volt Power Supplies Premium

20,0 Joule



14,0 Joule



## Power Profi NDi 15000 digital

- ultra high-capacity power supply unit with intelligent power adjustment that uses the maximum permissible limit values
- for extremely long fences, heavy vegetation and very robust animals
- our all-round device for more demanding applications - ideal for horses, cattle, sheep, goats, and for deterring wild boars and wolves
- 5-year warranty

## Power Profi NDi 10000 digital

- extremely high-capacity power supply unit with intelligent power adjustment
- for robust animal species such as cows, sheep, horses and for deterring wild animals and wolves – for long fences with heavy vegetative growth
- 5-year warranty

Digital Display Readout for Fence and Earth Voltage and Energy Consumption

Digital Display Readout for Fence and Earth Voltage and Energy Consumption



Ref. no.			€
372815	1	81	

Ref. no.			€
372810	1	81	

Model	Ref. no.														
NDi 10000 digital	372810	14 J	10 J	0.55 J	10,200 V	9,600 V	6,900 V	300 km	80 km	18 km	9 km	35	4	2	13 W
NDi 15000 digital	372815	20 J	14.5 J	0.6 J	10,200 V	9,600 V	7,000 V	350 km	100 km	22 km	12 km	40	5	3	18 W



# Power Profi Ni/N

Made in Germany



- extremely powerful 230 volt mains energisers
- for very strong animals and for very long fences- even with vegetative growth
- bright LED displays allow for easy visual monitoring of the current fence and device status at a glance
- AKO Ni/N devices automatically adapt to the fence status, ensuring the highest protection certainty and making your work easier by reducing vegetation growth to a certain degree
- Ni equipment: an alarm function continuously monitors the fence, triggering an alarm and slowing the pulse sequence if the fence is touched for a longer period
- robust, impact-resistant, UV-resistant and weather-resistant housing thanks to the use of high-quality plastics
- microprocessor controlled
- integrated hanging device for wall mounting
- corresponds to applicable EU safety standards

5-year warranty

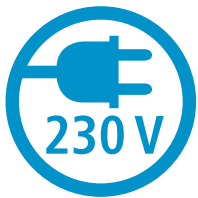

Monitors the fence voltage

Checks the earthing status

Checks energy consumption

Fitted with two fence output terminals 'out'  
Max.  
Min.

14,0 Joule



## Power Profi Ni 10000

- extremely powerful 230 volt power supply
- for long fences with heavy vegetation
- designed for robust animal species such as cattle, sheep, horses, and for deterring wild boars and wolves
- the fence is constantly monitored by an alarm function, which triggers an alarm and slows the pulse sequence if the fence is touched for an extended period of time
- very low power consumption in normal operating mode
- 5-year warranty

2-colour LED lights for output voltage, earthing status and power consumption



Ref. no.	Box	Tray	€
372811	1	81	



Discover devices with smart functions in the „Smart products“ section!

from page 22

10,0 Joule



7,0 Joule



7,0 Joule



## Power Profi Ni 7000

- extremely powerful 230 volt power supply
- for long fences with heavy vegetation
- designed for robust animal species such as cattle, sheep, horses, and for deterring wild boars and wolves
- the fence is constantly monitored by an alarm function, which triggers an alarm and slows the pulse sequence if the fence is touched for an extended period of time
- very low power consumption in normal operating mode
- 5-year warranty

## Power Profi N 5000

- very effective 230 volt power supply
- can be used with medium to heavy vegetative growth
- designed for robust animal species such as cattle, sheep, horses, and for deterring wild boars and wolves
- 5-year warranty

## Power Profi N 70

- very effective 230 volt power supply
- can be used with medium to heavy vegetative growth
- designed for robust animal species such as cattle, sheep, horses, and for deterring wild boars and wolves
- our all-round device for all types of animal
- 5-year warranty



Promotional device with excellent value for money

2-colour LED lights for output voltage, earthing status and power consumption

Multi-colour LED Bar Graph Display for Monitoring Fence and Earth Voltage

Multi-colour LED Bar Graph Display for Monitoring Fence and Earth Voltage



Ref. no.			€
372807	1	81	

Ref. no.			€
372804	1	108	

Ref. no.			€
372777	1	108	

Model	Ref. no.														
N 70	372777	7 J	5 J	0.55 J	10,000 V	9,200 V	6,800 V	140 km	45 km	9 km	4.5 km	20	3	2	7 W
N 5000	372804	7 J	5 J	0.55 J	10,000 V	9,200 V	6,800 V	140 km	45 km	9 km	4.5 km	20	3	2	7 W
Ni 7000	372807	10 J	7.5 J	0.55 J	10,000 V	9,500 V	6,700 V	230 km	70 km	15 km	7.5 km	30	4	2	9 W
Ni 10000	372811	14 J	10 J	0.55 J	10,200 V	9,600 V	6,900 V	300 km	80 km	18 km	9 km	35	5	3	13 W

# Power N

Made in Germany



- Our all-round devices for demanding applications.
- can be used with light to medium vegetative growth
  - robust, impact-resistant, UV-resistant and weather-resistant housing thanks to the use of high-quality plastics
  - microprocessor controlled
  - easy handling
  - integrated hanging device for wall mounting
  - very bright, clearly visible LED light
  - corresponds to applicable EU safety standards

5-year warranty



- N 1200:** Function indicator light
- N 3500:** combined fence voltage and earthing control
- N 4800:** multi-colour LED bar graph display for monitoring fence condition (i.e. fence wire insulation and device earthing are checked simultaneously)

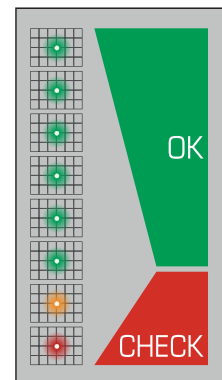



# 230 Volt Power Supplies Classic

6,7 Joule



5,5 Joule



1,7 Joule



## Power N 4800

- extremely powerful 230 volt power supply
- can be used with medium to heavy vegetative growth
- Our all-round devices for more demanding applications - ideal for horses, cattle, sheep, goats and for keeping wild animals and wolves at bay
- 5-year warranty

## Power N 3500

- very effective 230 volt all-round power supply
- can be used with light to medium vegetative growth
- universally suitable for standard fences
- ideal for horses, cows, sheep, goats, chickens
- 5-year warranty

## Power N 1200

- effective 230 volt power supply
- for short fences and low vegetation
- ideal for small horse paddocks
- 5-year warranty

Multi-colour LED bar graph display for monitoring the fence/earthing status



Ref. no.			€
372886	1	121	

combined fence voltage and earthing control LED



Ref. no.			€
372883	1	88	

Function Indicator LED



Ref. no.			€
372881	1	88	

Model	Ref. no.													
N 1200	372881	1.7 J	1.2 J	12,500 V	9,000 V	3,400 V	40 km	10 km	2 km	1 km	5	1		5 W
N 3500	372883	5.5 J	3.5 J	11,500 V	10,000 V	5,700 V	90 km	20 km	6 km	2.5 km	14	2		7 W
N 4800	372886	6.7 J	4.8 J	9,000 V	8,600 V	5,700 V	130 km	30 km	8 km	4 km	18	3	1	7 W

## AKOtronic

Made in Germany



### AKOtronic S7K

- the cow trainer for shed use
- optical power control (LED flashes green with every pulse)
- with automatic switch off (device switches off after 5 short circuit pulses – LED then flashes red)
- 3-year warranty

5-year warranty



With time control: device pulses for 2 hours followed by a rest period of 5 hours. This sequence is constantly repeated.

0,13 Joule



Important: Please note local animal welfare laws before use!



Ref. no.			€
350728	1	96	





# DUO Units (12 V / 230 V)



solar modules  
optionally  
available



## DUO electric fence units 2 in 1

12/230 Volt DUO units – maximum flexibility combined with powerful output energies. Two power input options available – 230 Volt mains supply or 12 Volt battery. This means the unit can be used both for permanent fencing with a 230 V mains supply and for mobile fencing with a 12 V battery.

Made in Germany



## Recommended accessories:

(not included)



Ground Rod with round profile item no. 442380



AKO Warning Sign item no. 446513



Ground connection cable 3 m 44635/011



12 Volt, AGM battery  
Item No. 442067 75 Ah  
Item No. 441203 88 Ah  
Item No. 441204 110 Ah



Underground cable,  $\varnothing$  1.6 mm item No. 44817, 44930, 44932, 44933



Battery charger item No. 371037



Metal battery case item No. 44656, 44650



Digital Duo Voltmeter item No. 442328

## Power Pack All Weather DUO

- for connection to 230 V supply
- not suitable as a battery charger
- especially suitable for outdoor use
- not for XDi and smart devices



Ref. no.		€
371024	1/60	



# Duo Power Xi

Made in Germany



- 12/230 Volt DUO Unit – maximum flexibility combined with powerful output
- multi-colour, illuminated bar graph display (10 LEDs) for monitoring the output voltage
- separate LED for battery warning (red)
- optimised consumption thanks to energy saving mode – saves battery power in fences in good condition. Also intelligent battery management for when battery voltage decreases.
- deep discharge protection for the 12 volt battery
- microprocessor controlled
- Solar backup possible
- robust, impact-resistant, UV-resistant and weather-resistant housing thanks to the use of high-quality plastics
- integrated hanging device for wall mounting
- corresponds to applicable EU safety standards
- (suitable for metal box 44656 and 44650)

5-year warranty

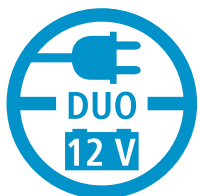

- AKO Xi device automatically adapts to the fence status, ensures highest protection certainty, and makes your work easier by reducing vegetation growth to a certain degree
- the fence is constantly monitored by an alarm function, which triggers an alarm and slows the pulse sequence if the fence is touched for an extended period of time
- Delayed shock strength adjustment makes touching the fence safer for people and animals



multi-colour LED bar graph display (10 LEDs) for monitoring the output voltage

Separate LED for battery warning (red)

Connection socket for back-up operation (optional)  
The unit is normally connected to a 12-Volt battery at the bottom screw cap and at the same time to the 230-Volt power pack (371012 - not included) at the top socket. If the 230-Volt mains supply fails, the unit automatically switches to 12-Volt operation.

High/low/off switch

Duo connection for 230 Volt operation or 12 Volt battery operation

Fence output (option of strong/weak)

Earth

**Included in delivery:**

- 1 x 12/230 Volt DUO Fence Device,
- 1 x 230 volt power pack (371030),
- 1 x 12-Volt connection cable (E268739),
- 1 x fence / ground connector cable,
- 1 x warning sign

12 Joule 



multi-colour LED bar graph display for output voltage and battery control

## Duo Power Xi 8000

- extremely powerful DUO fence device for mobile or stationary use
- our all-round device – ideal for horses, bulls, sheep and for deterring wild boars and wolves
- can be used even with heavy vegetation
- with High/Low/OFF switch for 2 different output powers
- 5-year warranty

recommended solar module: 375999 (100 Watt), connection directly to the 12-Volt battery, optionally with ground anchor 442382 or fixing set 442386 for metal box















Ref. no.			€
372878	1	72	



Discover devices with smart functions in the „Smart products“ section!  
from page 22



Model	Ref. no.													
Xi 8000	372878	12 J	8 J	11,200 V	10,200 V	8,700 V	240 km	50 km	17 km	7 km	30	6	3	155 - 560 mA

# Duo Power X

Made in Germany



5-year warranty



- optimised power consumption thanks to energy-saving mode
- deep discharge protection with 12 V operation
- microprocessor controlled
- plug connector with screw fuse
- robust, impact-resistant, UV-resistant and weather-resistant housing thanks to the use of high-quality plastics
- integrated hanging device for wall mounting
- very bright, clearly visible LED light
- corresponds to applicable EU safety standards
- (suitable for metal box 44656 and 44650)

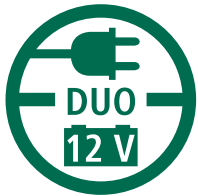

On/off switch  
(For Duo Power X4000, Duo Power X2500)

fence or function indicator LED and  
battery warning indicator

X 4000:  
multi-colour LED bar graph display for output  
voltage and battery control

plug connector with screw fuse



Discover devices with smart functions in  
the „Smart products“ section!

from page 22

#### Included in delivery:

- 1 x fence unit,
- 1 x 230 volt power pack (371023),
- 1 x 12-Volt connection cable (E268739),
- 1 x ground connector cable,
- 1 x fence connector cable,
- 1 x warning sign (44623)



5,5 Joule



3,2 Joule



**Top Seller**



1,6 Joule



## Duo Power X 4000

- 12 V / 230 V DUO device with extremely high output power
- for longer fences, also with vegetation
- ideal for use also with strong animals and for keeping wild boar and wolves at bay
- with High/Low/OFF switch for 2 different output powers
- 5-year warranty

recommended solar module:  
Item number. 375251 (25 Watt), connection directly to the 12-Volt battery, mounting e.g. on a metal box or: Item number 375559 (55 Watt), connection directly to the 12-Volt battery plus ground anchor kit 442382 or fixing set 442386 for metal box



## Duo Power X 2500

- 12 V / 230 V DUO unit with high output
- for normal fence systems with low vegetation
- with On/Off switch
- 5-year warranty

recommended solar module:  
Item number. 375251 (25 Watt), connection directly to the 12-Volt battery, mounting e.g. on a metal box



## Duo Power X 1000

- 12 V / 230 V DUO unit with effective output power
- for short fences without vegetation
- 5-year warranty

recommended solar module: item number 375151 (15 Watt), connection directly to the 12-Volt battery, mounting e.g. on a metal box



multi-colour LED bar graph display for output voltage and battery control

Fence control LED and separate battery warning indicator

Function control LED and visual battery warning indicator



Ref. no. €  
372874 1 88

Ref. no. €  
372872 1 88

Ref. no. €  
372871 1 88

Model	Ref. no.												
X 1000	372871	1.6 J	1 J	10,500 V	9,000 V	4,400 V	35 km	10 km	1.5 km	0.8 km	4	1	115 mA
X 2500	372872	3.2 J	2.5 J	9,600 V	8,300 V	6,400 V	70 km	18 km	4 km	1.7 km	10	2	75 - 193 mA
X 4000	372874	5.5 J	4 J	11,900 V	10,300 V	8,400 V	110 km	35 km	9 km	4 km	16	2	117 - 300 mA



# 12 V Battery Units



solar modules optionally available



## Strong output even on fences with heavier vegetation!

12 V battery units are ideal for very robust animals, long fences and/or fences with vegetation if no 230 V connection is available. The discharge energy is comparable to that of power energisers (output approx. 0.5 to 5 joules). Rechargeable 12 V batteries are used as the power source, and must be recharged every 2 – 4 weeks or so depending on the type of unit, required power and battery type. Solar modules, which convert solar energy into electricity and therefore constantly top up the 12 V battery, are a good add-on. All our 12 V units have deep discharge protection, helping you maintain the performance of the 12 batteries.

Made in Germany



## The advantages at a glance:

- Mobile
- Powerful
- Rechargeable
- Solar option
- Deep discharge protection

## Recommended accessories:

(not included)



Ground Rod with round profile item no. 442380



Ground connection cable 3 m 44635/011



12 Volt, AGM battery  
Item No. 442067 75 Ah  
Item No. 441203 88 Ah  
Item No. 441204 110 Ah



Metal battery case item No. 44656, 44650



Underground cable, ø 1.6 mm item No. 44817, 44930, 44932, 44933



AKO Warning Sign item no. 446513



Digital Duo Voltmeter item No. 442328

## 230 Volt Power Pack

- for connection to a 230 Volt supply (can therefore be operated both with or without 12 Volt battery)

for AD 2000 digital, AD 3000 digital, AD 5000, A 1200



Not suitable as a battery charger for large 12 Volt batteries (over 30 Ah).

Ref. no.	Icon	€
371012		1/80



# Mobil Power AD

Made in Germany



5-year warranty



- with 12 Volt full discharge protection
- The shock strength can be steplessly adjusted with the manual controller (1 - 20)
- Can be operated via a 230-V power pack (371012 - not included)
- integrated solar charge controller
- digital display to indicate the fence voltage, battery voltage and power level
- robust, impact-resistant, UV-resistant and weather-resistant housing thanks to the use of high-quality plastics
- large battery container for the 12-Volt battery
- microprocessor controlled
- very bright, clearly visible LED light
- corresponds to applicable EU safety standards



#### Variable output control:

Normal field operation 1 – 15  
Extreme conditions 16 – 20



**Battery voltage:** Displays the current battery voltage in V. The 12 V battery should be connected to 12 V minimum – and ideally over 12.5 V.



**Fence output voltage:** Display of the output voltage in kV. Enables even the smallest changes to fence status to be detected.



Recommended 12 V battery: 88 Ah AGM, item No. 441203 (max. L x W x H 281 x 184 x 225 mm)

#### Included:

- 1 x fence device,
- 1 x fence / ground connection cable,
- 1 x warning sign,
- 1 x 12 Volt connection cable (item No. E263616 available separately for AD 2000 digital and AD 3000 digital)
- 1 x 9 Volt connection cable (item No. E263617 available separately for AD 2000 digital and AD 3000 digital)

# 12 Volt Battery Units Premium

7,4 Joule



5,7 Joule



3,0 Joule



## Mobil Power AD 5000 digital

- ultra high-capacity 12 volt battery unit for mobile, extreme applications and heavy vegetative growth
- not suitable for 9 Volt operation.
- 5-year warranty

recommended solar module: 375559 (55 W), connection directly to the 12-Volt battery - ideal with ground anchor kit 442382



... can also be used to ward off game and wolves!

Digital Display Readout and LED Lights for Fence and Battery Voltage



Ref. no.			€
372591	1	33	

## Mobil Power AD 3000 digital

- extremely effective 12 volt power supply for mobile and extreme usage
- allows for alternative operation with 9 Volt dry battery
- 5-year warranty

Recommended solar module: Item number 375256 (25 Watt) - mounting directly on the device handle



... can also be used to ward off game and wolves!

Digital Display Readout and LED Lights for Fence and Battery Voltage



Ref. no.			€
372291	1	33	

## Mobil Power AD 2000 digital

- extremely powerful 12 Volt battery unit for mobile use, long fences with vegetation and powerful animals
- allows for alternative operation with 9 Volt dry battery
- 5-year warranty

Recommended solar module: Item number 375156 (15 Watt) - mounting directly on the device handle

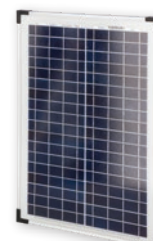

... can also be used to ward off game and wolves!

Digital Display Readout and LED Lights for Fence and Battery Voltage



Ref. no.			€
372201	1	33	

Model	Ref. no.													
AD 2000	372201	3 J	2.1 J	0.5 J	10,500 V	9,600 V	5,200 V	55 km	20 km	8 km	3 km	8	3	17 - 220 mA
AD 3000	372291	5.7 J	3 J	0.5 J	10,800 V	9,800 V	6,000 V	90 km	30 km	10 km	4 km	12	3	17 - 290 mA
AD 5000	372591	7.4 J	4.6 J	1 J	11,000 V	10,000 V	6,500 V	115 km	38 km	14 km	5.5 km	18	5	100 - 460 mA

# Mobil Power AN

Made in Germany



5-year warranty



- extremely powerful fence device for 12-Volt battery operation
- All-round devices for demanding, mobile use
- multi-colour LED bar graph display for monitoring the output voltage
- separate LED for battery warning (red)
- optimised consumption thanks to energy saving mode – saves battery power in fences in good condition. Also intelligent battery management for when battery voltage decreases.
- deep discharge protection for the 12 volt battery
- microprocessor controlled
- Solar backup possible
- can be operated via a 230-V power pack (371023 - not included)
- robust, impact-resistant, UV-resistant and weather-resistant housing thanks to the use of high-quality plastics
- integrated hanging device for wall mounting
- very bright, clearly visible LED light
- corresponds to applicable EU safety standards
- (suitable for metal box 44656 and 44650)



multi-colour LED bar graph display (10 LEDs) for monitoring the output voltage

Separate LED for battery warning (red)

connection socket for back-up operation\* (optional) and solar connection AN 4000  
 \* The unit is normally connected to a 12-Volt battery at the bottom screw cap and at the same time to the 230-Volt mains adapter (371012 - not included) at the top socket. If the 230-Volt mains supply fails, the unit automatically switches to 12-Volt operation.

High/low/off switch

connection for 12-Volt battery operation or optionally for 230-Volt operation (371023)

Fence output (option of strong/weak)

Earth

Included in delivery: 1 x fence unit, 1 x fence / ground connector cable, 1 x 12-Volt connection cable (E268739), 1 x warning sign



Discover devices with smart functions in the „Smart products“ section!

from page 22

Recommended 12 V battery: 110 Ah AGM, item no. 441204



# 12 Volt Battery Unit Expert

7,0 Joule



5,5 Joule



## Mobil Power AN 6000

- extremely powerful 12 Volt fence device for demanding mobile use
- can be used with medium to heavy vegetative growth
- our all-round device for more demanding mobile or static applications - ideal for horses, cattle, sheep and deterring wild boars and wolves
- with High/Low/OFF switch for 2 different output powers
- Solar backup possible
- 5-year warranty

recommended solar module: 375559 (55 Watt), connection directly to the 12-Volt battery, optionally with ground anchor 442382 or fixing set 442386 for metal box



multi-colour LED bar graph display for output voltage and battery control



Ref. no.			€
372555	1	72	

## Mobil Power AN 4000

- very powerful fence device for 12 volt battery operation
- can be used with light to medium vegetative growth
- our all-round device for demanding applications - ideal for horses, cattle, sheep, goat and deterring wild animals
- solar support possible with integrated charge control
- with High/Low/OFF switch for 2 different output powers
- 5-year warranty

recommended solar module: 375256 (25 Watt), for direct connection to the device and for attachment to the metal box



multi-colour LED bar graph display for output voltage and battery control



Ref. no.			€
372554	1	72	

Model	Ref. no.													
AN 4000	372554	5.5 J	4 J	11,900 V	10,300 V	8,400 V	110 km	35 km	9 km	4 km	16	2	117 - 300 mA	
AN 6000	372555	7 J	5 J	12,000 V	10,400 V	9,000 V	130 km	40 km	11 km	6 km	20	2	130 - 370 mA	

# 12 Volt Battery Unit Expert



4,5 Joule 5-year warranty

3,2 Joule 5-year warranty



**Top Seller**

## Savanne 3000

Includes metal box

- 12 volt rechargeable battery device with extremely high power output
- for long fence systems with heavy vegetative growth
- also available as a starter set
- with On/Off switch
- 5-year warranty

recommended solar module: item number 375251 (25 Watt), connection directly to the 12-Volt battery, mounting e.g. on the metal box



## Savanne 2000

Includes metal box

- 12 V device with high output power for normal fencing systems, even with heavier vegetative growth
- with On/Off switch
- 5-year warranty

recommended solar module: item number 375251 (25 Watt), connection directly to the 12-Volt battery, mounting e.g. on the metal box



Fence control LED and separate battery warning indicator

Fence control LED and separate battery warning indicator



Ref. no.			€
372754	1	27	

Ref. no.			€
372752	1	27	



with On/Off switch

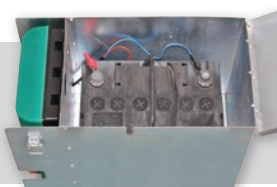

Internal dimensions approx. 295 x 200 x 250 mm, suitable for batteries with max. 100 Ah (battery not included in scope of supply)

Model	Ref. no.												
Savanne 2000	372752	3.2 J	1.9 J	9,600 V	8,300 V	6,100 V	60 km	20 km	5 km	2 km	7	2	75 - 193 mA
Savanne 3000	372754	4.5 J	3 J	9,600 V	8,300 V	6,300 V	95 km	35 km	12 km	5 km	12	3	77 - 300 mA

# 12 Volt Battery Unit Expert



2,1 Joule



5-year warranty



## Mobil Power A 1200

- Universal, very effective 12 volt battery unit for mobile use
- two separate LEDs for fence voltage and battery control
- manual turn switch (1 – 10) adjusts output energy steplessly – this makes power input adjustable to adapt more efficiently to fencing conditions
- Can be operated via a 230-V power pack (371012 - not included)
- allows for alternative operation with 9 Volt dry battery
- 5-year warranty

recommended solar module: item no. 375156 (15 watts)



Ref. no.			€
372121	1	33	

- normal field operation: level 1 - 7
- extreme operation: level 8 - 10
- On/Off



Model	Ref. no.													
A 1200	372121	2.1 J	1.4 J	0.48 J	10,700 V	9,000 V	4,400 V	40 km	10 km	5 km	1.5 km	5	2	15 - 150 mA



# Power A

Made in Germany



5-year warranty



Our 12-Volt Classic device is cheap and offers simplified functions for all standard fences with normal vegetation.

- with 12 Volt full discharge protection
- Crocodile clips made of high-quality stainless steel
- low energy consumption thanks to energy-saving mode
- robust, impact-resistant, UV-resistant and weather-resistant housing thanks to the use of high-quality plastics
- integrated hanging device for wall mounting
- very bright, clearly visible LED light
- corresponds to applicable EU safety standards



On/off switch

Fence voltage control

Battery voltage control  
(red LED flashes when battery reaches 40 % of its remaining capacity)

### Included:

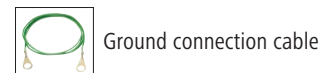

Ground connection cable



Fence connecting wire



Warning Sign (44623)

# 12 Volt Battery Unit Classic



## Power A 2000

- efficient 12 volt battery unit for mobile use
- ideal for horse and cattle fences
- with On/Off switch
- Solar backup possible
- 5-year warranty

recommended solar module: item no. 375151 (15 watts) – for connecting directly to the 12 volt battery



Fence control LED and separate battery warning indicator



Ref. no.			€
372892	1	88	

Model	Ref. no.												
A 2000	372892	3.5 J	2.5 J	9,600 V	9,600 V	7,200 V	85 km	25 km	5 km	2.5 km	10	3	90 - 220 mA

# Starter Set for Fences

Complete set up to 20 % cheaper than buying the parts individually!

These sets include AKO products for your fence, perfectly matched by experts. This guarantees perfect operation right from the start when connected to your fence. And your wallet will be happy, because you will save a lot of money compared to buying the products individually!



## Starter Kit Mobil Power AD 3000 digital

- Joule input: 5.7 J

### Set consisting of:

- 1 x Mobil Power AD digital fence unit,
- 1 x AGM battery 12 Volt, 88 Ah,
- 3 x ground rod mobile,
- 2 x ground cable 3 m



Ref. no.	Description		€
441112	no solar module	1	
441113	incl. 25 Watt solar module	1	





## Starter Kit Mobil Power AN 6000

• Joule input: 7.5 J

### Set consisting of:

- 1 x Mobil Power AN fence unit,
- 1 x AGM battery 12 Volt, 88 Ah,
- 1 x battery box ( 44656),
- 3 x ground rod mobile,
- 2 x ground cable 3 m



Ref. no.	Description		€
441136	no solar module	1	
441137	incl. 55 Watt solar module, solar charge controller and metal box mounting kit (442386)	1	

## Starter Kit Savanne 3000

• joule input: 4.5 J

### Set consisting of:

- 1 x Savanne 3000 fence unit,
- 1 x AGM battery 12 Volt, 88 Ah,
- 3 x ground rod mobile,
- 2 x ground cable 3 m



Ref. no.	Description		€
441120	no solar module	1	
441121	incl. 25 Watt solar module and solar charge controller	1	



## Use the natural power of the sun!

AKO SunPOWER = extremely powerful, mobile compact solar units. Crystalline solar modules in combination with our high-performance solar fence devices are able to supply power to fences which are many kilometres in length. Even after a whole week without direct sunlight, these fence devices still have sufficient power to supply your fence with sufficient current. These special devices are outstandingly suited for fencing relatively large areas. Sufficient voltage is supplied everywhere along the fence, without the requirement for a socket anywhere nearby!

Made in Germany



## Solar electricity – environmentally-friendly, cost-effective energy!

- No maintenance or follow-up costs.
- Maintenance-free operation from spring to autumn

Tip: Charge the battery during longer breaks in operation (such as winter). solar fence device is switched off

1. Disconnect the 12 volt battery from the solar fence device and only reconnect it for commissioning after storing it.
2. Connect the 230 volt mains charger to the red (+) and black (-) terminals on the 12 volt battery.
3. Now plug the adapter into the socket and charge as follows:

- a) ... at least 1 day before storage
- b) ... at least every 3 months during breaks in operation
- c) ... at least 1 day before commissioning
- d) storage temperature: frost-free up to 20 degrees

IMPORTANT: 230-Volt mains charger can also remain permanently connected to the battery during the entire storage period.

## Recommended accessories:

(not included)



Spiral ground/retaining anchor  
item No. 442383 (for S 4000, S  
3800, S 3000, S 2400 smart, S  
1500)



Wooden post mount stainless  
steel, incl. wood screws item No.  
442384 (for S 4000, S 3800, S  
3000, S 2400 smart, S 1500)



T-Post installation



Ground Rod with T-pro-  
file 1 m item no. 44615

Ground Rod with T-pro-  
file 2 m item no. 441369





## Spiral Ground/Retaining Anchor for Solar Units

- Total height of ground anchors (incl. thread) 120 cm
- suitable for SunPower S 4000, S 3800, S 3000, S 2400 smart and S 1500

**Included in delivery:** 1 x spiral ground/retaining anchor, 1 x screw set, 1 x Screw-in assistance



Ref. no.	Height		€
442383	120 cm	1	

solar unit not included

## Wooden Post Mount

- for theft-proof mounting on the wooden post
- incl. padlock and spare key
- incl. metal and wood screws
- suitable for SunPower S 4000, S 3800, S 3000, S 2400 smart and S 1500



Ref. no.	Material		€
442384	stainless steel	1	

solar unit not included



# Sun Power S

Made in Germany



5-year warranty



- optimised for permanent, maintenance-free operation right through the main pasture season
- with High/Low/Off switch
- integrated lightning protection
- intelligent, modern battery management with deep discharge protection – device functions even during extended periods of bad weather
- excellent level of efficiency – therefore a longer battery life
- very robust, weather-resistant, water-tight casing with carrying handle
- fast and easy to install
- power saving switch for when battery voltage fails
- additional power saving function when the fence status is good
- 5-year performance guarantee on the solar module
- microprocessor controlled
- very bright, clearly visible LED light
- corresponds to applicable EU safety standards



High/low/off switch

LEDs for fence monitoring, solar operation and battery warnings

Integrated locking screw for fixing to the metal post

Housing block for mounting on wooden post mount stainless steel 442384 or on spiral ground/retaining anchor 442383

duct for metal post mounting

**Important: you must use several additional ground rods if the ground is dry (e.g. item no. 44615)**



Discover devices with smart functions in the „Smart products“ section!  
from page 22

# Solar Units Premium



5,3 Joule



4,2 Joule



2,3 Joule



New product

NEW

## Sun Power S 3800

- very powerful all-round compact solar unit
- can be used with light to medium vegetation, universally for all standard fences
- ideal for horse and cattle paddocks, goats, sheep and for wolf defence
- 5-year warranty

### Included in delivery:

1 x solar fence device\*,  
1 x AGM battery, 12 volt, 18 Ah (441125)\*,  
1 x 12-Volt crystalline solar module, 40 Watt (not assembled) \*,  
1 x 230 volt battery mains charger (371012),  
1 x fence connector cable,  
1 x ground connector cable,  
1 x two-part ground/installation spear (442385),  
1 x warning sign,  
\* Warranty: solar fence device (5 year warranty), solar module (5 year performance warranty), 12 volt battery (6 month warranty)

## Sun Power S 3000

- All-round compact solar device
- can be used with light to medium vegetation, universally for all standard fences
- ideal for horse and cattle paddocks, goats, sheep and wolf
- 5-year warranty

### Included in delivery:

1 x solar fence device\*,  
1 x AGM battery, 12 volt, 18 Ah (441125)\*,  
1 x 12-Volt crystalline solar module, 30 Watt (not assembled) \*,  
1 x 230 Volt battery mains charger (371012 from model year 06/2024, before 371032),  
1 x fence connector cable,  
1 x ground connector cable,  
1 x two-part ground/installation spear (442385),  
1 x warning sign,  
\* Warranty: solar fence device (5 year warranty), solar module (5 year performance warranty), 12 volt battery (6 month warranty)

## Sun Power S 1500

- powerful compact solar unit for normal fence systems with little vegetation
- ideal for horse and cattle paddocks, goats, poultry, domestic pigs
- 5-year warranty

### Included in delivery:

1 x solar fence device\*,  
1 x AGM battery, 12 volt, 18 Ah (441125)\*,  
1 x 12-Volt crystalline solar module, 15 Watt (E262115) (not assembled) \*,  
1 x 230 volt battery mains charger (371012 from model year 2024, before 371032),  
1 x fence connector cable,  
1 x ground connector cable,  
1 x two-part ground/installation spear (442385),  
1 x warning sign,  
\* Warranty: solar fence device (5 year warranty), solar module (5 year performance warranty), 12 volt battery (6 month warranty)

multi-coloured LED bar graph display for output voltage and battery control plus solar operation LED (blue)



Ref. no.			€
372955	1	24	

multi-coloured LED bar graph display for output voltage and battery control plus solar operation LED (blue)



Ref. no.			€
372952	1	24	

Fence control LED and visual battery warning indicator plus solar operation LED (blue)



Ref. no.			€
372951	1	24	

## Spare battery

Ref. no.	Voltage	Capacity		€
441125	12 V	18 Ah	1/2	

Model	Ref. no.													
S 1500	372951	2.3 J	1.5 J	10,000 V	10,000 V	4,800 V	45 km	15 km	3 km	1.5 km	6	2	25 - 130 mA	
S 3000	372952	4.2 J	3 J	11,000 V	10,000 V	7,600 V	95 km	30 km	6 km	3 km	12	2	59 - 223 mA	
S 3800	372955	5.3 J	3.8 J	11,000 V	10,200 V	8,300 V	100 km	33 km	8 km	3.5 km	14	2	120 - 300 mA	



# Sun Power S

Made in Germany



- optimised for permanent, maintenance-free operation right through the main pasture season
- with High/Low/Off switch
- power saving switch for when battery voltage fails
- integrated lightning protection
- intelligent, modern battery management with deep discharge protection – device functions even during extended periods of bad weather
- excellent level of efficiency – therefore a longer battery life
- very robust, weather-resistant, water-tight casing with carrying handle
- fast and easy to install
- channel integrated into the housing for post mounting
- microprocessor controlled
- very bright, clearly visible LED light
- corresponds to applicable EU safety standards

5-year warranty

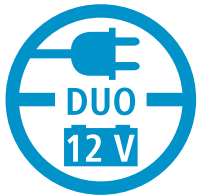





1,4 Joule



0,75 Joule



## Sun Power S 1000

- powerful solar device for normal fence systems with little vegetation
- ideal for horse and cattle paddocks as well as poultry nets
- 5-year warranty\*

function indicator LED (green) plus solar operation LED (blue) plus battery warning LED (red)

## Sun Power S 500

- effective solar device for normal fences without vegetation
- ideal for horse and cattle paddocks
- 5-year warranty\*

function indicator LED (green) plus solar operation LED (blue) plus battery warning LED (red)

### Included in delivery:

1 x High-Power Compact Solar Device Sun Power S 1000 (fully assembled) \*,  
 1 x AGM battery, 12 Volt, 12 Ah (441124)\*,  
 1 x permanently mounted, crystalline solar module, 12 Volt, 8 Watt \*,  
 1 x 230 volt battery mains charger (371032),  
 1 x fence connector cable,  
 1 x ground connector cable,  
 1 x two-part ground/installation spear (442385),  
 1 x warning sign,  
 \* Warranty: solar fence device (4 year warranty), solar module (5 year performance warranty), 12 volt battery (6 month warranty)



Ref. no.	Quantity	€
372950	1	

## Spare battery

Ref. no.	Voltage	Capacity	Quantity	€
441124	12 V	12 Ah	1/4	

### Included in delivery:

1 x High-Power Compact Solar Device Sun Power S 500 (fully assembled) \*,  
 1 x AGM battery, 12 Volt, 7 Ah (441130)\*,  
 1 x permanently mounted, crystalline solar module, 12 Volt, 8 Watt \*,  
 1 x 230 volt battery mains charger (371032),  
 1 x fence connector cable,  
 1 x ground connector cable,  
 1 x two-part ground/installation spear (442385),  
 1 x warning sign,  
 \* Warranty: solar fence device (4 year warranty), solar module (5 year performance warranty), 12 volt battery (6 month warranty)



Ref. no.	Quantity	€
372949	1	

## Spare battery

Ref. no.	Voltage	Capacity	Quantity	€
441130	12 V	7 Ah	1/5	

Model	Ref. no.	In	Out max.	max.	No Load	500 Ω	theor.	max.	max.	max.	50 m	1 m	fuel
S 500	372949	0.75 J	0.55 J	10,800 V	10,200 V	4,300 V	18 km	6 km	1.7 km	0.2 km	1	31 - 43 mA	
S 1000	372950	1.4 J	1 J	11,000 V	10,000 V	5,000 V	35 km	10 km	2.5 km	1 km	4	59 - 81 mA	

Important: If ground is dry, several additional ground rods must be used.

# Sun Power S

Made in Germany



5-year warranty



Use the natural power of the sun!

- optimised for maintenance-free continuous operation over the grazing season on fences with little vegetation
- with On/Off switch
- integrated battery charge regulation
- micro-controller controlled
- integrated lightning protection
- intelligent battery management – device functions even during long periods of poor weather
- excellent level of efficiency – therefore a longer battery life
- very robust, weather-resistant housing
- power saving switch for when battery voltage fails
- 5-year performance guarantee on the solar module



0,4 Joule



- On/off switch
- function indicator LED (green) plus solar operation LED (blue) plus battery warning LED (red)
- Battery compartment
- duct for post mounting

Included in delivery: 1 x solar unit, 1 x integrated 12 V, 5 Ah battery (441218) (6-month warranty), 1 x integrated 12 V, 3 W solar module, 1 x 230 Volt power pack (371032) to recharge the gel battery and/or to trickle charge during the winter months, 1 x connector cable for fence and earth connection, 1 x earth rod, 1 x warning sign

## Sun Power S 250

- highly effective compact solar device
- ideal for hose paddocks and smaller fence systems without vegetation
- Deep discharge protection for battery voltage < 11.2 Volt - (if activated => only red flashing)
- 5-year warranty

function indicator LED (green) plus solar operation LED (blue) plus battery warning LED (red)



Ref. no.			€
372920	1	90	
372920-RE	1	90	

372920-RE:  
• from recycled plastic



Ref. no.	Description		€
441218	AGM Spare Battery 12 Volt, 5 Ah	1/8	

Model	Ref. no.										
S 250	372920	0.4 J	0.25 J	10,500 V	10,500 V	2,800 V	6 km	3 km	0.7 km	1	22 mA
S 250	372920-RE	0.4 J	0.25 J	10,500 V	10,500 V	2,800 V	6 km	3 km	0.7 km	1	22 mA





# Solar technology



The power of the sun supplies the fence and battery with energy: save yourself effort and money on the time-intensive changing and charging of batteries. By allowing a suitably powerful solar module to repeatedly support and charge the rechargeable batter, your fence is supplied with power and requires little maintenance.

## Solar Panel

- 5-year warranty

375156: incl. stainless steel holder for mounting and connecting directly to the electric fence - solar cable length 100 cm

375256: incl. stainless steel holder for mounting and connecting directly to the electric fence - solar cable length 100 cm

375151: incl. stainless steel holder for mounting on metal box 44656 or 44650 - for connection directly to 12 Volt battery - solar cable length 100 cm

- incl. charge controller

375251: incl. stainless steel holder for mounting on metal box 44656 or 44650 - for connection directly to 12 Volt battery - solar cable length 100 cm

- incl. charge controller

375559: incl. 4 x stainless steel clamping plate + M8 screws, for connection directly to the 12 Volt battery - solar cable length 200 cm. Mounting either on spiral ground/retaining anchor 442382 OR by means of mounting kit 442386 on metal box 44656 or 44650

375999: incl. 2 x stainless steel horizontal struts, for connecting directly to the 12 Volt battery - solar cable length 200 cm. Mounting either on spiral ground/retaining anchor 442382 OR by means of mounting kit 442386 on metal box 44656 or 44650.

The direct connection to the devices means that no charge controller is required for solar modules 375156 and 375256.

Ref. no.	Output solar module	suitable for	Width	Height	Depth		€
375156	15 W	A 1200	37.5 cm	37 cm	2 cm	1	
375256	25 W	AN 4000, AD 2000, AD 3000	37.5 cm	56 cm	2 cm	1	
375151	15 W	X 1000, A 2000, Savanne 2000	37.5 cm	37 cm	2 cm	1	
375251	25 W	X 2500, X 4000, A 2000, Savanne 2000, Savanne 3000	37.5 cm	56 cm	2 cm	1	
375559	55 W	AN 6000, Xi 8000, AD 5000, X 6000 smart	53.6 cm	55.7 cm	2.5 cm	1	
375999	100 W	XDi 10000, XDi 15000, Xi 8000	66.4 cm	100 cm	3.5 cm	1	

## Installation options for the 55 and 100 Watt solar module 375559 and 375999

### A Mounting on the spiral ground/retaining anchor:



#### Items required for this type of mounting:

1. 55 or 100 Watt solar module
2. Spiral ground/retaining anchor set 442382
3. Optional: Solar extension cable 441600



### Spiral Ground/Retaining Anchor

- Total height of ground anchors (incl. thread) 120 cm

#### Set consisting of:

- 1 x spiral ground/retaining anchor,
- 2 x stainless steel vertical rail, 1 x screw set, 1 x Screw-in assistance



Ref. no.	Height			€
442382	120 cm	1	30	

solar module not included

### B Mounting on metal box:



#### Items required for this type of mounting:

4. 55 or 100 Watt solar module
5. Metal box assembly set 442386
6. Metal battery case Standard 44656 or anti-theft case 44650

### Metal Box Assembly Kit

- this mounting set also allows the solar module to be optionally installed higher up on a wooden post

#### Set consisting of:

- 2 x stainless steel vertical rail,
- 1 x stainless steel U-holder, 1 x screw set



Ref. no.		€
442386	1/15	

solar module and metal box not included

### Extension Cable Set

- optional cable for extension - especially if the distance from the solar module to the 12 Volt battery is longer than 2 m
- 2 x 5 m cable for the extension of the plus and minus connection
- further extension up to 20 m possible without problems
- only for the 55 and 100 Watt solar module 375559 and 375999

Set consisting of: 2 x 5 m cable for plus/minus extension

Ref. no.	Length	MOQ	Pieces / unit		€
441600	5 m	1 pack	2 / pack	1	



## Solar Module 4 Watt

- 1 x 4 Watt solar module with mount
- suitable for all 9 V devices
- solar module supports or relieves the 9 V battery during daylight hours. The battery energiser draws power from the solar module during daylight hours. The solar module cannot be used to charge to 9 or 12 V battery.



**Important: Device is not included.**

Ref. no.	Output solar module	Width	Height	Depth		€
377024	4 W	21 cm	20 cm	2 cm	1	

## Solar Set 5 Watt

The solar module permanently charges the battery during the main grazing season. The battery can be recharged any time using the 230 volt mains energiser. Recommendation: During winter storage connect the battery to the power pack for 24 hours approx. every 2 months.

**Set consisting of:** 1 x solar module 5 watts with holder, 1 x AGM battery, 12 V, 15 Ah incl. charging control, 1 x 230-Volt power pack (371012) 1 x 230 Volt Netzteil (371012)

Recommendation: During winter storage connect the battery to the power pack for 24 hours approx. every 2 months.

**Important: Device is not included.**

Ref. no.	Output solar module		€
377056	5 W	1	



## 9 volt solar technology

### 9 volt devices with solar module 377024

#### Solar module and 9 volt dry battery:

In contrast to the 12 volt devices, the 9 volt devices are operated directly from the solar modules. During this time, the 9 volt battery is barely impacted. At night and during periods of bad weather, the device is operated from the 9 volt battery. This significantly extends the battery's working life.

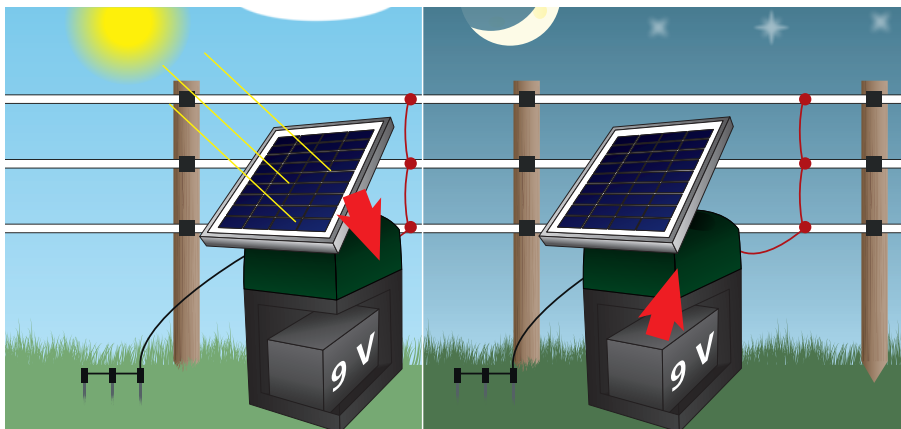

### 9 Volt devices with solar module kit 377056

#### 5 watt solar module and 12 volt battery:

The solar module permanently charges the battery during the main grazing season. The battery can be recharged any time using the 230 volt mains energiser.

- can be used for 9 Volt dry battery devices which are also 12 Volt-capable

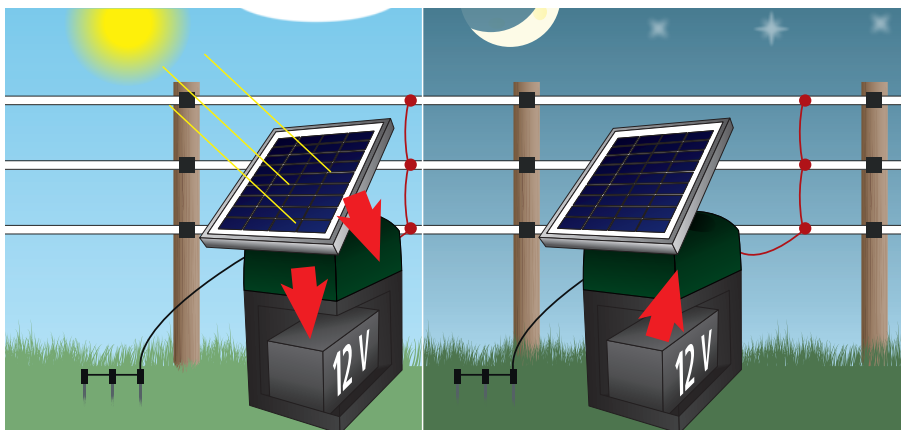





## Anti-Theft-Box

- electrifiable metal battery box made from galvanised steel
- space for one battery unit max. 36.5 cm x 11 cm x 37 cm or all 12 volt devices for wall mounting
- space for one 12 V battery max. 36.5 cm x 21.5 cm x 21 cm
- lockable, lock included in the scope of delivery (incl. spare key)
- with metal carry handle

Matching solar modules:

- 375151, 375251
- 375559, 375999 (only with mounting kit 442386)



Including solid 80 cm long assembly / ground pole

**Important: Unit and battery are not included!**

Ref. no.	Width	Depth	Height		€
44650	37.5 cm	33,5 cm	37.5 cm	1	

## Metal Battery Boxes

- space for batteries up to 130 Ah
- ideal for use with solar modules
- internal dimensions of battery compartment: W 36 cm x H 32 cm x D 21 cm
- space for one battery unit max. 36.5 cm x 11 cm x 37 cm or all 12 volt devices for wall mounting
- Material: galvanised metal
- with metal carry handle

Matching solar modules:

- 375151, 375251
- 375559, 375999 (only with mounting kit 442386)



44652



**Important: Unit and battery are not included!**

Ref. no.	Width	Depth	Height			€
44656	37.5 cm	33.5 cm	37.5 cm	1	24	

Ref. no.	Description	MOQ	Pieces / unit		€
44652	Anti-theft Kit for Metal Battery Cases	1 pack	1 / pack	1	







# 9 Volt Dry Battery Energizers



## The ideal units for smaller fences and paddocks!

9 V battery units are suitable for shorter fence lengths without vegetation. They are highly mobile and significantly lighter than 12 V units. The 9 V battery runs for several months and can even cover a complete pasture season, depending on the operating time, battery type and size. Once discharged, it cannot be recharged. The units can alternatively also run on a 12 V battery, making them flexible to use.

- including ground rod and fence/earth connection cable
- battery not included

## The advantages at a glance:

- compact and mobile
- flexible to use
- for movable fences and smaller pastures

Made in Germany



## Recommended accessories:

(not included)



Alkaline 9 volt, 175 Ah, item no. 350531



AGM battery 12 Volt, 15 Ah, item No. 441215



Solar support see page



Ground connection cable 3 m 44635/011



AKO Warning Sign item no. 446513



Ground Rod with round profile item no. 442380



Digital Duo Voltmeter item No. 442328

## Adaptor Cable

- connects 12 Volt wet rechargeable battery
- for connection to all our 9 V electrical fences
- with 2 crocodile clips
- Cable length: 80 cm

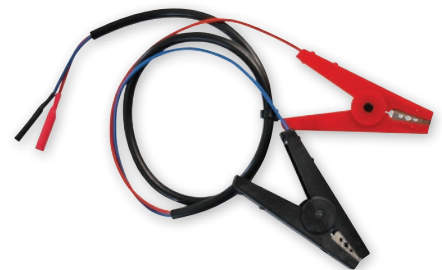

Ref. no.	Colour	Pieces / unit	€
44641/011	black / red	1 / pack	1/90



# Power Station BD

Made in Germany



5-year warranty



- large digital display on top of the device gives the user all key information at a glance – even in darkness
- automatic mode – minimal energy consumption thanks to optimised, independent adjustment of the output power in line with the fence length and status. Battery consumption is therefore minimal and optimum security is maintained over a very large fenced area
- can be operated via 230 V power pack
- allows for optional operation with 12 V battery – with deep discharge protection
- robust, impact-resistant, UV-resistant and weather-resistant housing thanks to the use of high-quality plastics
- very bright, clearly visible LED light
- corresponds to applicable EU safety standards



multi-colour LED bar graph display for monitoring the output voltage



Output voltage in kilovolts



Battery supply voltage in volts and battery status symbol



- 1-4: Power levels for normal to extreme fence conditions
- AUTO: Unit automatically selects the optimum power level from 1 to 4

## 230 Volt Power Pack for 9 Volt Battery Units

- only for PowerStation BD and B260 multi



Ref. no.		€
371016	1/14	

# 9 Volt Dry Battery Units Premium

0,7 Joule



Foal Protection Switch



## Power Station BD 600 digital

- our most powerful 9 V battery unit for longer fences and heavy vegetative growth
- highest discharge energy ensures optimum tending safety
- allows for alternative operation with 12 Volt and 230 Volt
- 5-year warranty

### Included in delivery:

- 1 x fence unit,
- 1 x earth rod,
- 1 x fence / ground connector cable,
- 1 x warning sign

Digital display for fence and battery voltage. LED bar graph supports fence voltage control.



Ref. no.			€
372036	1	54	

0,51 Joule



Foal Protection Switch



## Power Station BD 400 digital

- extremely powerful 9 V battery unit for medium fences and moderate vegetative growth
- the perfect solution for all animal species such as horses, cattle, goats, dogs and poultry
- allows for alternative operation with 12 Volt and 230 Volt
- 5-year warranty

### Included in delivery:

- 1 x fence unit,
- 1 x earth rod,
- 1 x fence / ground connector cable,
- 1 x warning sign

Digital display for fence and battery voltage. LED bar graph supports fence voltage control.



Ref. no.			€
372034	1	54	

0,38 Joule



## Power Station BD 300 digital

- powerful 9 V battery unit
- ideal horse and cattle paddocks with little vegetative growth
- also for small animals such as dogs, cats and poultry
- allows for alternative operation with 12 Volt and 230 Volt
- 5-year warranty

### Included in delivery:

- 1 x fence unit,
- 1 x earth rod,
- 1 x fence / ground connector cable,
- 1 x warning sign

Digital display for fence and battery voltage. LED bar graph supports fence voltage control.



Ref. no.			€
372033	1	54	

Model	Ref. no.												
BD 300	372033	0.38 J	0.3 J	0.1 J	11,000 V	11,000 V	3,500 V	10 km	6 km	4 km	1.5 km	1	13 - 36 mA
BD 400	372034	0.51 J	0.4 J	0.16 J	11,400 V	10,900 V	3,900 V	13 km	8 km	5.5 km	1.7 km	1	13 - 44 mA
BD 600	372036	0.7 J	0.55 J	0.2 J	11,700 V	10,700 V	4,100 V	18 km	10 km	7 km	2 km	1	13 - 61 mA

# Power Shock B

Made in Germany



- visual check for fence insulation and battery voltage
- allows for optional operation with 12 V battery – with deep discharge protection
- robust, impact-resistant, UV-resistant and weather-resistant housing thanks to the use of high-quality plastics
- innovative closure technology
- easy handling
- very bright, clearly visible LED light
- corresponds to applicable EU safety standards

5-year warranty



- 5-step adjustable impact force using the manual rotary switch
  - This means that power consumption can be efficiently controlled and adjusted to the current fence conditions
  - Easy to use thanks to the optimum positioning of the switch and displays
- Multi-stage fence voltage control with coloured LEDs (green, yellow, red)
- Separate visual control for battery voltage (LED flashes red when the 9 V battery or 12 V rechargeable battery is flat)



# 9 Volt Dry Battery Units Expert

0,64 Joule



0,45 Joule



## Power Shock B 500 plus

- extremely powerful 9 volt dry battery device
- perfectly suited for horse and cattle paddocks
- increased output power and AUTO mode => minimal energy consumption through optimised, autonomous adjustment of the output power to the fence length and status
- battery unit for long fences and light vegetative growth
- up to max. 0.6 Joules in 12 V mode
- allows for alternative operation with 12 Volt battery
- 5-year warranty

## Power Shock B 290

- powerful 9-Volt universal fence device for small to medium fence systems with little vegetation
- perfectly suited for horse and cattle paddocks
- also ideal for strip grazing
- allows for alternative operation with 12 Volt battery
- 5-year warranty

### Included in delivery:

- 1 x fence unit,
- 1 x earth rod,
- 1 x fence / ground connector cable,
- 1 x warning sign

### Included in delivery:

- 1 x fence unit,
- 1 x earth rod,
- 1 x fence / ground connector cable,
- 1 x warning sign

Fence control LED and separate battery warning indicator

Fence control LED and separate battery warning indicator



Ref. no.			€
372030	1	54	

Ref. no.			€
372040	1	54	

The specified fence device values relate to performance level 5

Model	Ref. no.											
B 290	372040	0.45 J	0.29 J	10,500 V	10,500 V	3,300 V	13 km	5 km	2 km		1	18 - 44 mA
B 500 plus	372030	0.64 J	0.5 J	10,000 V	9,500 V	3,700 V	16 km	9 km	6 km	1.8 km	1	17 - 64 mA

# Compact Power B

Made in Germany



5-year warranty



- 9 V battery units with effective output
- visual check for fence insulation and battery voltage
- easy handling
- allows for optional operation with 12 V battery – with deep discharge protection
- easy to transport
- 6 daylight bright LEDs (bar graph display) for fence and battery monitoring
- includes robust carry handle
- microprocessor controlled
- with large on/off (magnetic) rotary switch
- robust, impact-resistant, UV-resistant and weather-resistant housing thanks to the use of high-quality plastics
- corresponds to applicable EU safety standards



separate LED for battery warning (red)

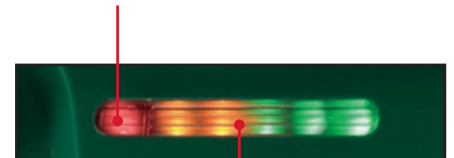

multi-colour LED bar graph display (5 LEDs) for monitoring the output voltage

Large on/off (magnetic) rotary switch



incl. installation ground rod

# 9 Volt Dry Battery Units Classic

0,45 Joule



0,38 Joule



0,26 Joule



## Compact Power B450

- highly effective 9/12 Volt fence device for mobile use
- for fences with low vegetation
- ideal for horses, cattle, pigs, poultry, dogs, cats and herons
- Level 1(Eco): 0.2 Joule output
- with High/Low/Off switch
- 5-year warranty

## Compact Power B260 multi

- highly effective 9/12/230 V fence device for mobile use
- for fences with low vegetation
- ideal for horses, cattle, pigs, poultry, dogs, cats and herons
- 5-year warranty

## Compact Power B180

- highly effective 9/12 Volt fence device for mobile use
- ideal for smaller horses and cattle pastures, also suitable for small animals such as dogs and cats
- the cost-efficient 'beginner's' 9 V battery energiser for mobile use in small pastures with little vegetation
- now also available in the on-trend colours of pink and petrol
- 5-year warranty

PROMO

includes high energy 9 volt battery, 75 Ah (44220)



### Included in delivery:

- 1 x fence unit,
- 1 x fence / ground connector cable,
- 1 x installation ground rod,
- 1 x warning sign,
- 1 x 9 Volt, 75 Ah battery (44220)

### Included in delivery:

- 1 x fence unit,
- 1 x 12 volt adapter cable (44641/011),
- 1 x 230 volt power pack (371016),
- 1 x fence / ground connector cable,
- 1 x installation ground rod,
- 1 x warning sign

### Included in delivery:

- 1 x fence unit,
- 1 x fence / ground connector cable,
- 1 x installation ground rod,
- 1 x warning sign

multi-colour LED bar graph display for output voltage and battery control

multi-colour LED bar graph display for output voltage and battery control

multi-colour LED bar graph display for output voltage and battery control



Ref. no.			€
372775	1	90	

Ref. no.			€
372026	1	54	

Ref. no.			€
372018	1	54	
372018-PETROL	1	54	
372018-PINK	1	54	

Model	Ref. no.										
B180	372018	0.26 J	0.18 J	8,800 V	8,400 V	2,700 V	6 km	3 km	0.5 km	1	23 mA
B260 multi	372026	0.38 J	0.26 J	9,800 V	9,100 V	3,100 V	8 km	4 km	1 km	1	34 mA
B450	372775	0.45 J	0.35 J	10,500 V	9,600 V	3,300 V	10 km	5 km	3 km	1	46 mA



# Compact Power



Hobby energisers are ideal for short fences with low vegetation. These devices are especially popular for mobile fences in gardens, mobile paddocks and trail riding. You will also find sets specially developed for these uses on the following pages, which contain everything you need to easily set up an electric fence.

Made in Germany



5-year warranty



N 700: Function indicator LED  
AN 550 and B40: Function indicator LED and battery warning indicator

## Ground/Support Rod

- ideal for DUO and hobby units (available as accessory)
- not compatible with Compact Power B 40 device (372005)
- Material: galvanised metal



Ref. no.			€
44657	1	100	



## Compact Power N 700

- highly effective 230 Volt fence device for mobile use
- specially designed for short fences
- ideal for horses, cattle, pigs, poultry, dogs, cats and herons
- 5-year warranty

### Included in delivery:

- 1 x Compact Power N 700,
- 1 x warning sign

Function Indicator LED



Ref. no.			€
372080	1	168	



## Compact Power AN 550

- inexpensive, effective 12 Volt fence device for mobile use
- ideal for horse and cattle fences – also for small animals like dogs, cats, poultry, rabbits and herons
- for normal fence systems with low vegetation
- with 12 Volt full discharge protection
- Crocodile clips made of high-quality stainless steel
- Low-battery mode: by means of the extended flashing interval (under 12 Volts to 11.5 Volts, pulse and LED flashing is extended to 3.5 sec., under 11.5 Volts, the LED flashes without pulse in an 8-sec. interval)
- Battery not included
- Solar backup possible
- 5-year warranty

### Included in delivery:

- 1 x Compact Power AN 550,
- 1 x fence / ground connector cable,
- 1 x warning sign

Function control LED and visual battery warning indicator



Ref. no.			€
372055	1	168	



## Compact Power B 40

- inexpensive, handy 3 Volt fence device
- for mobile use and small fences up to 200 m without vegetation
- ideal for the small fence in the garden, for trail riders and other „small fences“
- operated by 2 x 1.5 V single cell batteries (not included)
- Low-battery mode: by means of the extended flashing interval (under 12 Volts to 11.5 Volts, pulse and LED flashing is extended to 3.5 sec., under 11.5 Volts, the LED flashes without pulse in an 8-sec. interval)
- Run time with continuous use about 6 weeks
- Device fits in any coat pocket
- with On/Off switch
- 5-year warranty

### Included in delivery:

- 1 x Compact Power B 40,
- 1 x fence / ground connector cable,
- 1 x warning sign

Function control LED and visual battery warning indicator



Ref. no.			€
372005	1	168	

Model	Ref. no.												
N 700	372080	1 J	0.55 J	8,800 V	7,500 V	1,600 V	21 km	7 km	1 km	0.3 km	1	1	0.9 W
AN 550	372055	0.85 J	0.55 J	8,400 V	7,500 V	1,460 V	23 km	6 km	1 km			1	57 mA
B 40	372005	0.07 J	0.03 J	7,000 V	7,000 V	400 V	1 km	0.2 km				1	16 mA



## Portable Fence Kit for Trekking

- assembles and disassembles quickly and easily
- weight: about 3 kg

Set consisting of:

- 1 x battery energiser of 3 V (incl. 2 x 1.5 V batteries),
- 2 Gate Handles each with 50 m tape,
- 4 divisible aluminium posts of 1.15 m length,
- 5 x expanders with pegs,
- 8 insulators for round posts,
- 1 x carry bag



Ref. no.		€
44127	1/6	

## Hobbyset

The ideal fence to protect your garden and to fence in dogs and cats. Excellent to enclose ponds in order to prevent e.g. cats and herons from fishing!

441150:

- incl. Electric Fence Device N700

441151:

- incl. Electric Fence Device B40 + 2 x 1.5-Volt batteries

Set consisting of:

- 1 x electric fence device,
- 1 x fence / ground connector cable,
- 10 x fibreglass poles, green 70 cm,
- 30 x wire clips,
- 100 m poly wire green,
- 1 x earth rod,
- 1 x warning sign,
- 6 x ring insulators with wooden thread



Ref. no.	Description	Pieces / unit		€
441150	with power pack N700	1 / pack	1	
441151	with Battery Unit B40	1 / pack	1	

Ref. no.	Description	Colour	Material	Length	MOQ	Pieces / unit		€
441853	Spare Post	green					1/100	
444265/30	Spare spring for fibreglass rods of diameter 10 mm		stainless steel		1 pouch	30 / pouch	1/30/1500	
44874-100	Poly wire	green		100 m	1 pieces	1 / pieces	1/20	



## Tournament / Paddock Set 7 x 7 m

- Tournament/paddock set for approx. 7 x 7 m
- metal posts are ideally suited for dry and rocky ground
- no catching of mane or tail hair
- everything complete in one carry bag
- set up and dismantled in just a few minutes
- weight with device: 13.5 kg, without device: 12.5 kg

### Set includes:

4 x metal post galvanised with 153 cm total height, each comes with  
4 x FlexiRope incl. gate handle with galvanised hook and matching gate insulators



Ref. no.	Description		€
446500	without Fence Device	1	
446501	with Fence Device Compact Power B 40 (incl. 2 x 1.5 Volt batteries)	1	

## What does C100 mean when referring to the capacity of a rechargeable battery?

The usable capacity of a rechargeable battery is heavily dependent on the amount of discharge current. Since the rechargeable battery is completely discharged during a measurement, a discharge over a longer period (e.g. 100 hours for C100) means that the discharge current is much lower than during a rapid discharge (e.g. 20 hours at C20; C20 always applies when no other data are provided). As a result, a rechargeable battery in an application with very low discharge current has a higher usable capacity than when the same rechargeable battery is used within a shorter timespan and thus at a higher discharge current.

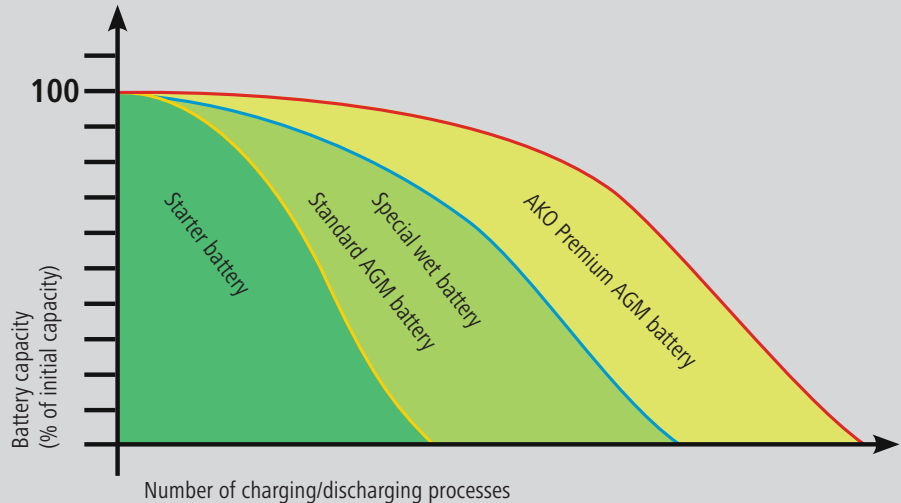

## Special Wet Rechargeable Battery 12 Volt

- extremely low self-discharge
- ideal for 12 V battery units with or without solar panel
- designed especially for fencing units due to its slow charge and discharge cycles
- acid: sulphuric acid 37 % = density of 1.28
- supplied without acid
- when not in use, the battery must be charged at least once a month
- „dry pre-charged“ battery
- charge completely after filling with acid
- capacity data for a 100-hour standard discharge (C100)
- 1-year warranty (note: warranty does not cover deep discharging)



**Important: for safety reasons, the batteries are supplied without battery acid. We recommend that they be filled by a professional „on site“!**

Ref. no.	Voltage	Capacity	L x W x H	Weight	Battery acid			€
442061	12 V	100 Ah	278 mm x 175 mm x 190 mm	12.7 kg	3.7 L	1	64	

## Battery Charger

for 12 Volt wet batteries and premium AGM batteries

- the multi-stage battery charger allows batteries to be charged to almost 100 % of their original capacity thanks to state-of-the-art technology
- automatic diagnosis, restoration, charging and maintenance of batteries over months thanks to fully automatic switching between charging and maintenance mode
- The following output options are available: 28.6 V, 29.2 V, 14.3 V, 14.6 V
- Charging current with 12 Volt battery: 2 A, 5 A and 10 A
- Charging current with 24 Volt battery: 2 A and 5 A
- no risk of over-charging
- electronically secured against user error
- spark-proof
- overheating protection with mini fan inside
- fully protected against short-circuits and incorrect connections
- suitable for charging and maintaining electric fence batteries as well as car batteries



Ref. no.		€
371037	1/8	





## AGM Battery



- rechargeable AGM Fleece Battery
- filled and charged, ready to install immediately
- 1-year warranty (does not cover deep discharging)
- capacity data for a 100-hour standard charge (C100)
- low self-discharging compared to standard batteries
- in OEM quality
- better charging behaviour (e.g. when charging via solar modules) and longer performance, even with short charging and discharging cycles (= more micro-cycle resistant) than conventional AGM batteries or standard lead-acid batteries
- can be stored for at least 9 months
- leakproof: Double cover with safety valve, gas recombination and backfire protection

- No acid required
- Completely leak-proof
- Maintenance-free – user-friendly

Made in the EU



## Premium AGM Battery

- immediately ready for use
- 1-year warranty (note: warranty does not cover deep discharging)



Top Quality

The new alternative to popular lead-acid batteries. The AGM fleece technology makes topping up battery acid a thing of the past. Fleece batteries are completely leak-proof, maintenance-free and extremely cycle-resistant.

All AKO AGM batteries also fit in metal boxes 44656 and 44650

Ref. no.	Voltage	Capacity	Length	Width	Height	Weight		€
442067	12 V	75 Ah	242 mm	175 mm	190 mm	17.9 kg	1	76
441203	12 V	88 Ah	275 mm	175 mm	190 mm	20.7 kg	1	68
441204	12 V	110 Ah	353 mm	175 mm	190 mm	26.4 kg	1	48

**IMPORTANT: AGM batteries are closed systems. Opening the battery voids the warranty!**



### Expert tip:

#### How to calculate the run time of your 12 volt battery:

1. Usable capacity = rated capacity x 0.65
2. Energy consumption of device (Ampere) = energy consumption in mA (see device type plate, e.g. 120 mA) : 1000
3. Operating period (hours) = usable capacity: energy consumption

#### Example:

1. 88 Ah x 0.65 = 57.2 Ah
2. 120 mA : 1000 = 0.120 A
3. 57.2 Ah : 0.120 A = 476 hours (19 days)





## Premium AGM Battery 32

- immediately ready for use
- for all 9 Volt devices that are also designed for 12 Volt operation
- must be installed lying on its side for some 9 V unit types
- incl. connection cable for 9 Volt devices
- 1-year warranty (note: warranty does not cover deep discharging)



ideal for 9 V devices

**IMPORTANT: AGM batteries are closed systems. Opening the battery voids the warranty!**

Ref. no.	Voltage	Capacity	L x W x H	Weight		€
441250	12 V	32 Ah	165 mm x 175 mm x 125 mm	7.8 kg	1	120

## Premium AGM 15 Ah Complete Set

- for all 9 Volt devices that are also designed for 12 Volt operation
- the rechargeable 12 Volt, 15 Ah (C100 or 12 Ah according to C20) AGM battery can be recharged via a power pack
- the integrated charger controller prevents overcharging and protects against deep discharge
- an optional 5-Watt solar module can be connected during grazing periods for continual operation (= complete set: 377056)
- 1-year warranty (note: warranty does not cover deep discharging)



ideal for 9 V devices

Included in delivery: 1 x AGM battery 12 V, 15 Ah (C100) incl. charging control, 1 x 230 Volt power pack

Ref. no.	Voltage	Capacity	L x W x H		€
441215	12 V	15 Ah	150 mm x 100 mm x 115 mm	1/4	

## Battery Tester

- test range 6 - 20 volts
- the open-circuit voltage (at the beginning) and the voltage under load (after the -- characters) are displayed.
- after a short while, the display shows „OF“ - the battery tester switches off automatically to protect the battery
- no batteries required



Ref. no.	Colour	Voltage levels		€
442369	black	6 - 20 V	1/16	

## Saline dry Battery 9 Volt High Energy

with carrying strap

„More power for less money“

- inexpensive, powerful alternative to alkaline batteries
- extended service life thanks to zinc-carbon technology
- ideal for all common standard 9 volt battery units
- Nominal voltage: 8,4 V



Ref. no.	Voltage	Capacity	L x W x H	Nominal voltage			€
44220	9 V	75 Ah	165 mm x 115 mm x 110 mm	8.4 V	1/4	360	

## Dry Battery Alkaline 9 Volt

9 volt alkaline batteries produce a constant high voltage output throughout their entire lifetime. The fence device therefore also emits a constant output during this time.

- free from mercury and cadmium

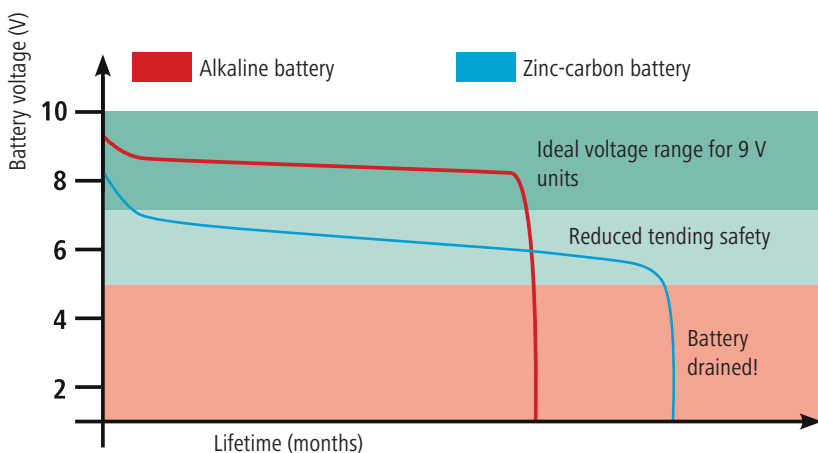

Alkaline Battery Display 350495 includes:  
9 x 175 Ah, ref. no. 350531  
18 x 120 Ah, ref. no. 350522

very good price/performance ratio  
All prices include disposal fee!

Ref. no.	Voltage	Capacity	L x W x H			€
350611	9 V	55 Ah	165 mm x 110 mm x 110 mm	1/4	360	
350681	9 V	75 Ah	165 mm x 110 mm x 110 mm	1/4	360	
350522	9 V	120 Ah	165 mm x 110 mm x 110 mm	1/4	360	
350528	9 V	170 Ah	190 mm x 125 mm x 160 mm	1/4	216	
350531	9 V	175 Ah	190 mm x 125 mm x 160 mm	1/4	216	
350534	9 V	210 Ah	190 mm x 125 mm x 160 mm	1/4	180	



## Zinc-Carbon Dry Battery

- standard dry type battery for application in electric fence equipment, not designed for high power
- Nominal voltage: 8,4 V



All prices include disposal fee!

Ref. no.	Voltage	Capacity	L x W x H	Nominal voltage			€
44212	9 V	55 Ah	165 mm x 115 mm x 110 mm	8,4 V	1/4	360	
44213	9 V	90 Ah	190 mm x 130 mm x 160 mm	8,4 V	1/4	216	
44219	9 V	130 Ah	190 mm x 130 mm x 160 mm	8,4 V	1/4	216	



## Digital DUO Voltmeter

New! Digital AKO "All-in-One" DUO voltmeter checks the voltage of fence devices, electric fences and 9 volt or 12 volt batteries. Conventional fence voltmeters only measure the fence (high) voltage and cannot read the lower battery voltages. Multimeters can test batteries but are damaged when testing the high voltages of electric fences. AKO's DUO voltmeter measures both high and low voltages with a single, inexpensive tool.

- All-in-one features:
- measures the high voltage on the device or fence in kilovolts (0.5 - 13.0-> 500 - 13,000 V) and the battery voltage in Volts (from 3 - 18 V). Values above this are indicated by „Hi“.
- digital display enables the precise display of the measured value
- lightweight and simple to use
- extra-long battery life thanks to power saving technology -> Lo = Low Batt Info
- operated with: 1 x 9 V Block Battery
- Battery included



Discover devices with smart functions in the „Smart products“ section!  
from page 22

Ref. no.	Colour		€
442328	black	1/100	



## Digital Defect Finder

- for precise troubleshooting of your electric fence. This device has a dual function – it is both a digital fence voltage tester and ammeter. This means you can easily detect potential error sources in your fence.
- Respective illuminated direction indicators help you to do so.
- includes ground spike
- operated with: 1 x 9 V Block Battery
- Battery included

Our multimeter has the advantage over conventional test equipment

- convenient and safe application due to ergonomic housing
- universal contact clips suitable for all conducting materials
- convenient measurement through automatic earthing

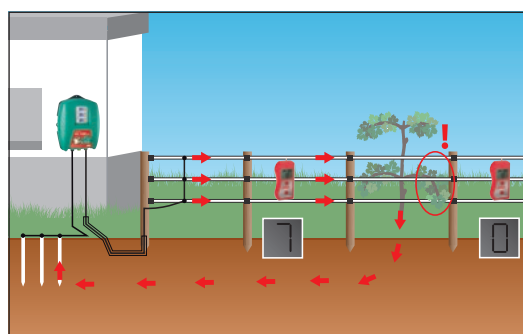

Ref. no.		€
442562	1/25	







## Fence Tester with LED Display

- easy measuring without ground spike
- measurement in the distance to the hedge of max. 0 - 5 cm
- shows the voltage via nine bright diodes in nine stages up to 10,000 Volts
- additional LED display (centre) for battery status (9 Volt block)
- operated with: 1 x 9 V Block Battery
- Battery included



New product

NEW

Ref. no.	Colour	Measurement Levels	Voltage levels		€
442326	black	9	0 - 10,000 V	1/100	



## Pulse Flash

- flashes green with every fence impulse
- under 3000 V light stops flashing and thereby shows that the fence is no longer safe
- using it on several spots on your fence gives you easy visual control of your fence status 'in situ' even during the day
- also ideal as additional defence against wild animals!
- attachment and electrical contact directly with the conductor material
- no batteries required

expert tip: Place the Pulse Flash at the end of your fence system. You can thus determine at a glance whether at the end of your fence (and therefore throughout your complete system) the voltage is flowing at 3000 Volt. This covers the minimum protective voltage for most animal species on normal soils.

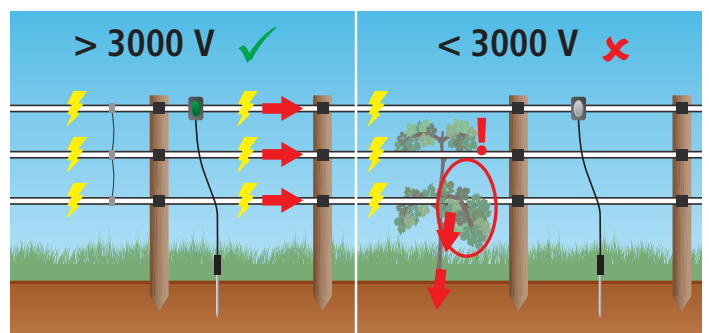

Ref. no.	Colour		€
442373	black	1/50	

# Testing and Control Equipment



## AKO Fence Tester, 8-tier

- for fence voltage measurement
- 8 lights indicate the fence voltage from 1,000 to 10,000 Volts
- facilitates daily checking of the fence tension
- includes ground spike
- no batteries required



Ref. no.	Colour	Voltage levels		€
442322	black	1,000 - 10,000 V	1/100	

## Fence-Checker

Visual and Audible fence Tester

- mini handheld display device for electric fences
- emits auditory and visual signals when the fence has a voltage
- incl. battery test function
- easy measuring without ground spike
- operated with: 1 x 12 V Alkaline
- Battery included



Perfect for cyclists and walkers!



Ref. no.	Colour		€
441227	black	1	

## Fence Tester

- ergonomic design
- displays the voltage in six stages
- for precise fence measurement
- includes ground spike
- no batteries required



Ref. no.	Colour	Measurement Levels	Voltage levels		€
441221	red	6	1,000 - 10,000 V	1/80	





Tip: Underground cable must be laid in a plastic conduit to prevent damage to the cable!

## High Voltage Underground Cable Premium

- double-insulated with tinned copper conductor
- ideal for supply lines from the device, inside the building, to the ground rod or fence outdoors
- also suitable for connecting several ground rods
- high voltage insulation up to 20.000 Volt



Ref. no.	Colour	Cable length	Exterior diameter	conductor diameter	Delivery	conductor cross-section	resistance Ω/m			€
440110	green	50 m	7.6 mm	1.6 mm	on a coil	1.5 mm <sup>2</sup>	0.014 Ω/m	1	144	
440111	green	100 m	7.6 mm	1.6 mm	on a coil	1.5 mm <sup>2</sup>	0.014 Ω/m	1	72	

## High Voltage Underground Cable

- double-insulated with galvanized steel wire core
- ideal for supply lines from the device, inside the building, to the ground rod or fence outdoors
- also suitable for connecting several ground rods
- ideal for permanent fence systems

44817: Underground cable is not supplied on a reel.



Ref. no.	Colour	Cable length	Exterior diameter	conductor diameter	Delivery	conductor cross-section	resistance Ω/m			€
44817	black	10 m	6 mm	1.6 mm	no reel	2 mm <sup>2</sup>	0.07 Ω/m	1	500	
44930	black	25 m	6 mm	1.6 mm	on a coil	2 mm <sup>2</sup>	0.07 Ω/m	1	216	
44932	black	50 m	6 mm	1.6 mm	on a coil	2 mm <sup>2</sup>	0.07 Ω/m	1	216	
44933	black	100 m	6 mm	1.6 mm	on a coil	2 mm <sup>2</sup>	0.07 Ω/m	1	117	
44931	black	50 m	7.2 mm	2.5 mm	on a coil	4.9 mm <sup>2</sup>	0.03 Ω/m	1	144	
44920	black	100 m	7.2 mm	2.5 mm	on a coil	4.9 mm <sup>2</sup>	0.03 Ω/m	1	72	



# Connection and Grounding Accessories

## High Voltage Underground Cable

- single-insulated with tinned copper conductor (bundled copper wires)
- ideal for supply lines from the device, inside the building, to the ground rod or fence outdoors
- also suitable for connecting several ground rods

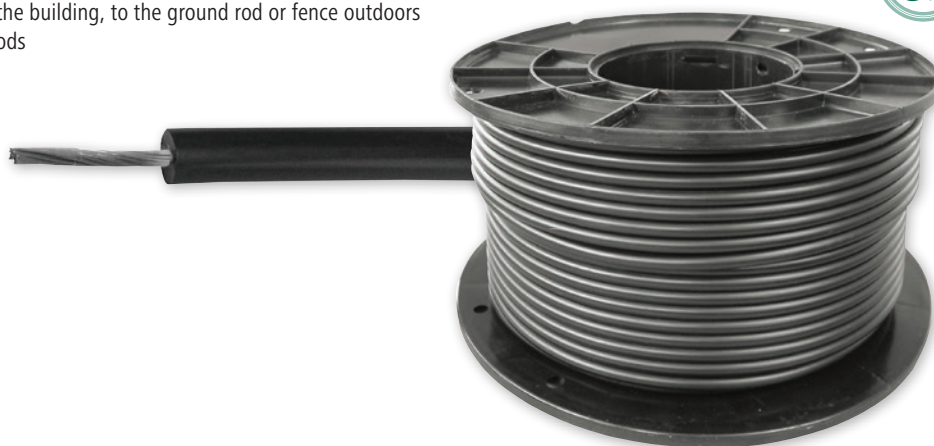

Ref. no.	Colour	Cable length	Exterior diameter	conductor diameter	Delivery	conductor cross-section	resistance $\Omega/m$			€
44630	black	25 m	7 mm	1.32 mm	on a coil	1 mm <sup>2</sup>	0.025 $\Omega/m$	1		216
44632	black	50 m	7 mm	1.32 mm	on a coil	1 mm <sup>2</sup>	0.025 $\Omega/m$	1		144

## Fence Power/Ground Connector Cable

- single-insulated with tinned copper conductor (bundled copper wires)
- with M8 eyelets
- ideal for supply lines from the device, inside the building, to the ground rod or fence outdoors
- also suitable for connecting several ground rods



Ref. no.	Colour	Cable length	Exterior diameter	conductor diameter	conductor cross-section	resistance $\Omega/m$		€
44635/011	black	3 m	7 mm	1.32 mm	1 mm <sup>2</sup>	0.025 $\Omega/m$	1/40	
44936/011	black	10 m	7 mm	1.32 mm	1 mm <sup>2</sup>	0.025 $\Omega/m$	1/15	

## High Voltage Cable Connector

- for the high voltage resistant, water-tight connection of high-voltage cables measuring exterior diameter 5.0 - 8.0 mm

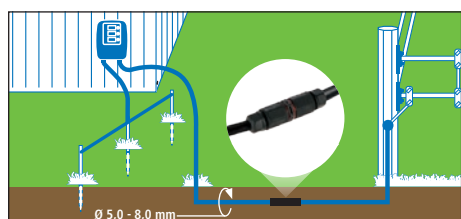

Ref. no.	Colour		€
440121	black	1/100	

# Connection and Grounding Accessories

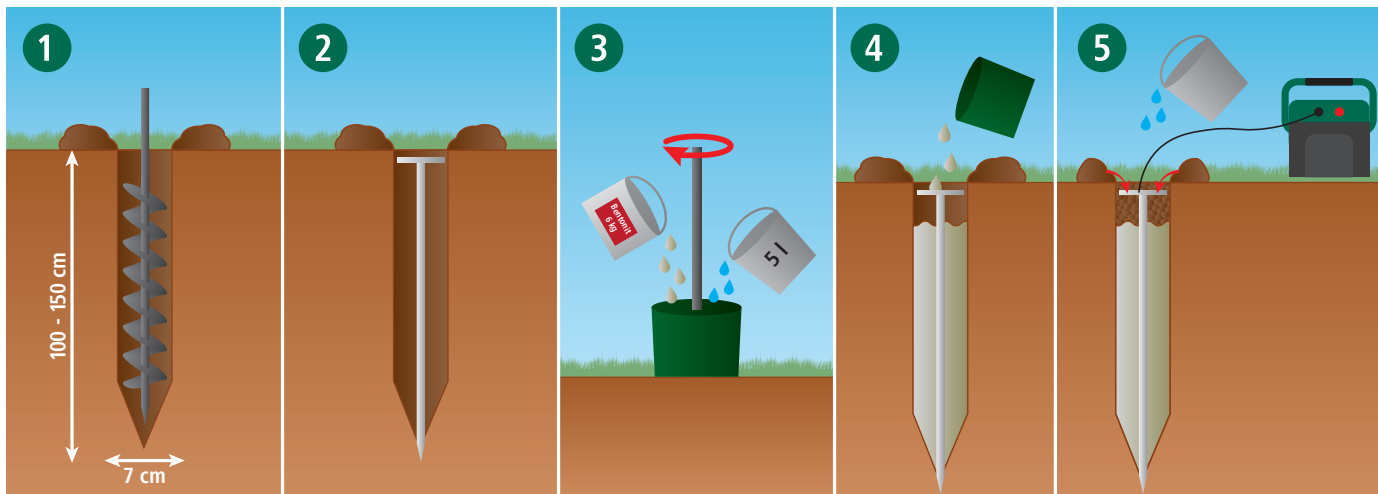

## Earthing mix Bentonit

- ensures perfect earthing even in difficult earthing conditions (e.g. dry or sandy soils)
- the special mixture of clay and salt attracts moisture and binds it directly in the ground around the earthing rods
- suitable for all kinds of ground rods
- the mass is easy and fast to stir in using 5 litres of water in a suitably large hole prepared for the ground rod



Ref. no.	Contents		€
442375	6 kg / Bucket	1	

## Special Ground Rod

- made from hot-dip galvanized T-steel
- with M6 stainless steel screw for connecting the ground connection cable
- Material: steel, hot-dip galvanized



Ref. no.	Height			€
44615	1 m	1	400	
441369	2 m	1	200	

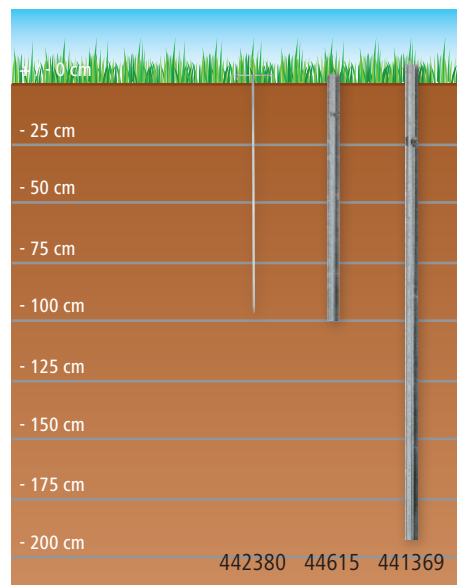

## Special Earth Rod for Mobile Use

- easy to pull out with T-handle
- with M6 stainless steel screw for connecting the ground connection cable
- Material: steel, hot-dip galvanized



Ref. no.	Height			€
442380	100 cm	1	500	



### Expert tip:

- Always insert the ground rods into damp soil.
- Maintain a distance of 3 m between the individual ground rods.
- Use galvanised ground rods – rust has an insulating effect and prevents voltage returning to the unit.

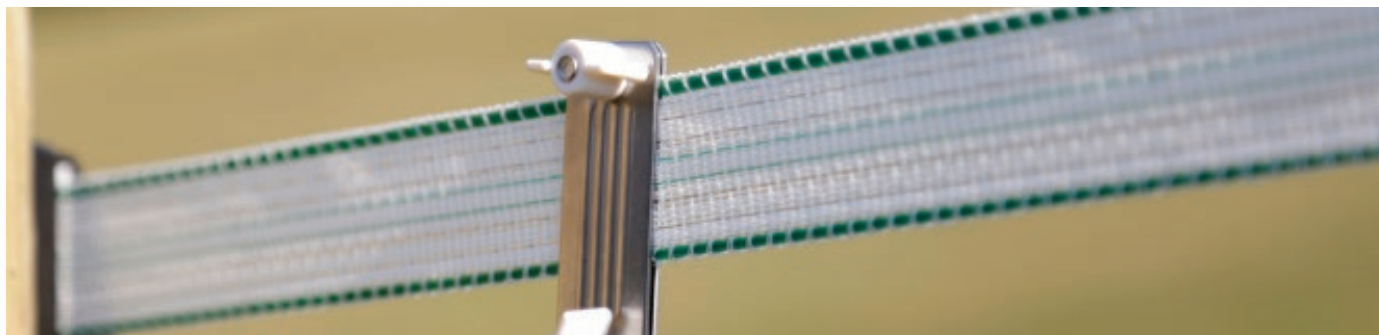

## Tape connector 3-way

- Stainless steel clamping plates
- Cable length: 2 x 60 cm
- the mechanically and electrically perfect connection between three fencing tapes

Stainless steel clamping plates

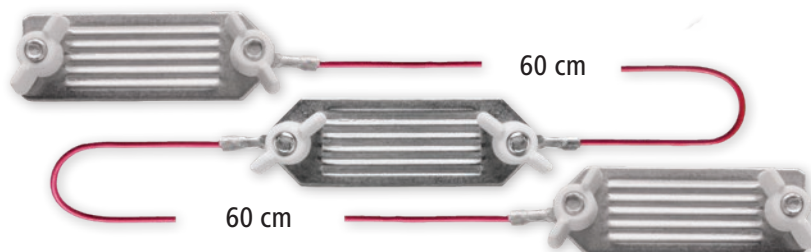

Ref. no.	can be used for	Pieces / unit		€
443027/011	tape up to 40 mm	1 / pack	1/90	

## Tape connector 2-way

- ideal mechanical and electrical connection between two fencing tapes
- Stainless steel clamping plates
- Cable length: 80 cm

Stainless steel clamping plates

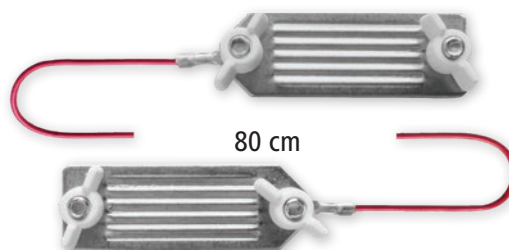



Ref. no.	can be used for	MOQ	Pieces / unit		€
44616/011	tape up to 40 mm	1 pack	1 / pack	1/90	

## Tape Connecting Cable

- the ideal mechanical and electrical connection between fence device and tape
- Stainless steel clamping plates
- with M8 metal eyelet
- Cable length: 130 cm

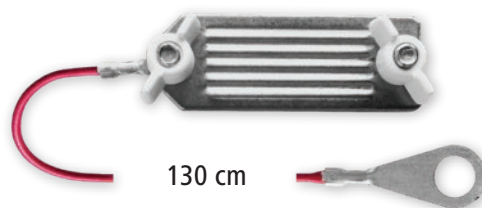
Stainless steel clamping plates





Ref. no.	Colour	can be used for	MOQ	Pieces / unit		€
44617/011	red	tape up to 40 mm	1 pack	1 / pack	1/90	

## Rope / tape connector

- the perfect mechanical and electrical connection between pasture fence rope and pasture fence tape
- Stainless steel clamping plates
- Cable length: 80 cm

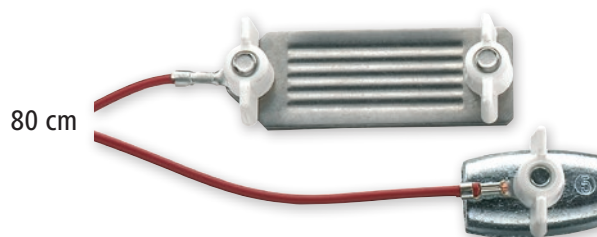
Stainless steel clamping plates



Ref. no.	Colour	can be used for	MOQ	Pieces / unit		€
441493/011	red	rope up to Ø 6.5 mm, tape up to 40 mm	1 pack	1 / pack	1/90	





## Ground and Fence Connector Cable

- Connecting parts made from stainless steel
- adapted contact surfaces of the alligator clips ensure optimal contacting of tapes of 10 - 40 mm width
- ideal connection from the device to the 40 mm fence tape
- with M8 metal eyelet
- Cable length: 120 cm

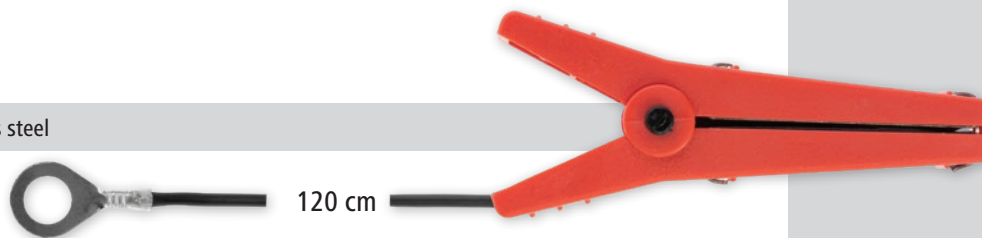

Connecting parts made from stainless steel



Ref. no.	Colour		€
443038/011	black	1/90	



## Fence connection cable, double

- Connecting parts made from stainless steel
- with 2 crocodile clips for electrification of 2-row fence systems having 40 mm fencing tapes
- adapted contact surfaces of the alligator clips ensure optimal contacting of tapes of 10 - 40 mm width
- Cable length: 60 cm

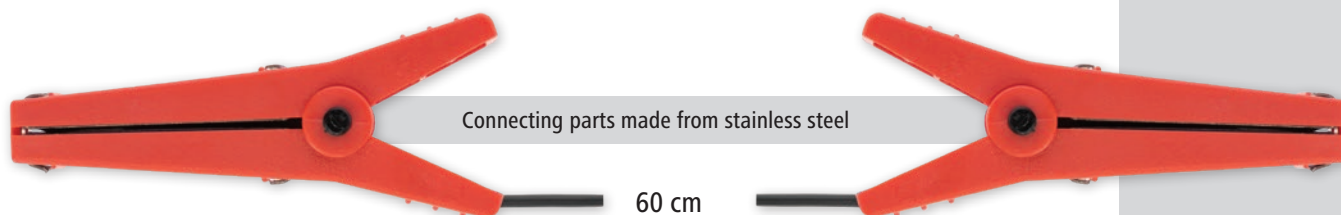

Connecting parts made from stainless steel

Ref. no.	Colour		€
443028/011	black	1/90	

## Fence Connection Cable, triple

- Cable length: 2 x 60 cm
- Connecting parts made from stainless steel
- with 3 crocodile clips for electrification of 3-row fence systems having 40 mm fencing tapes
- adapted contact surfaces of the alligator clips ensure optimal contacting of tapes of 10 - 40 mm width

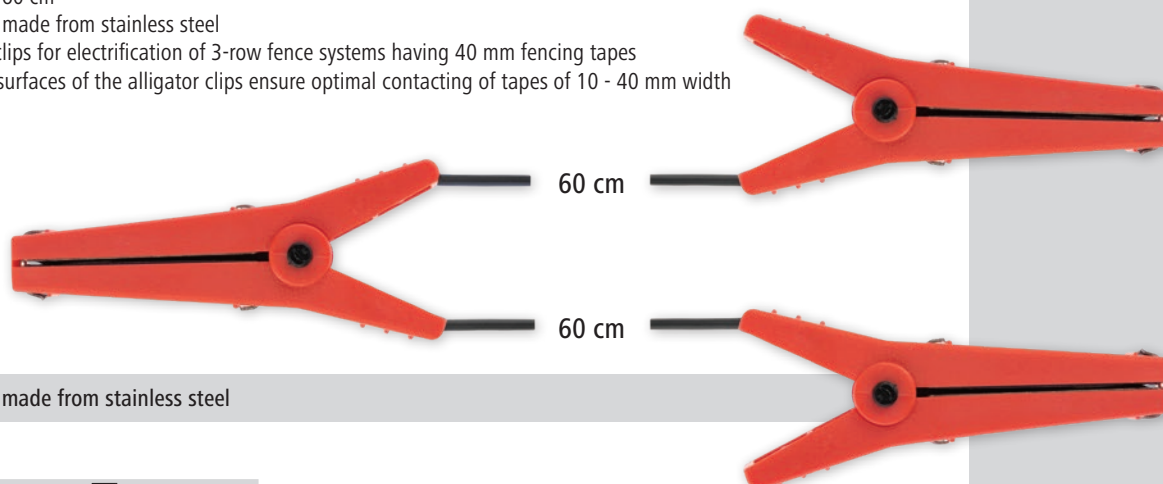

Connecting parts made from stainless steel

Ref. no.	Colour		€
443029/011	black	1/40	





# Connection and Grounding Accessories

## Ground and Fence Connector Cable

- Connecting parts made from stainless steel
- with M8 metal eyelet, with crocodile clip
- Cable length: 100 cm

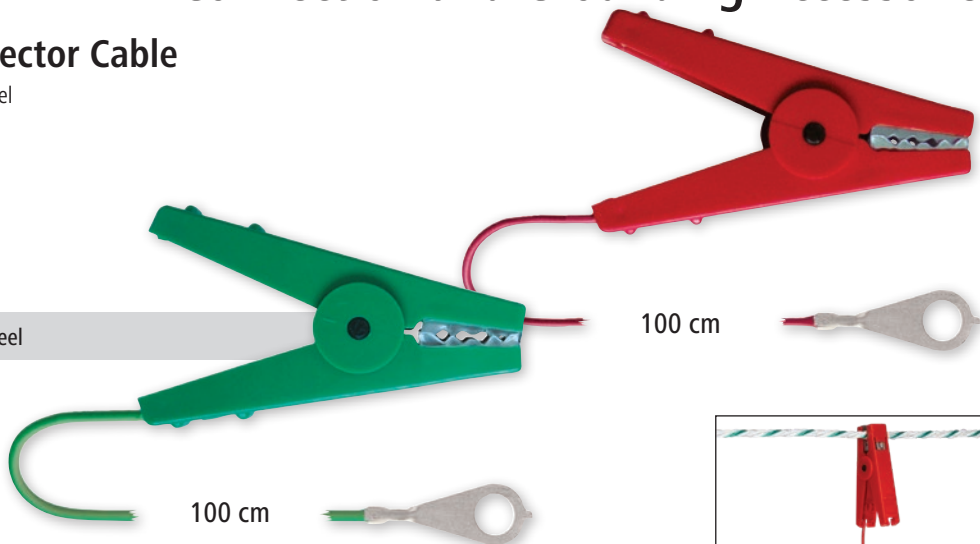
Connecting parts made from stainless steel



Ref. no.	Colour	MOQ	Pieces / unit		€
44605/011	red	1 pack	1 / pack	1/90	
44606/011	green	1 pack	1 / pack	1/90	

## Fence connection cable, double

- Connecting parts made from stainless steel
- with 2 crocodile clips
- Cable length: 60 cm

Connecting parts made from stainless steel

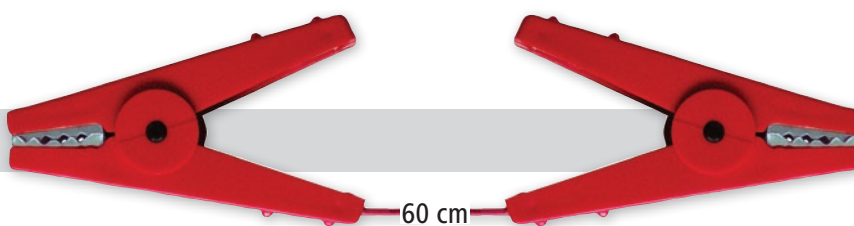

Ref. no.	Colour	MOQ	Pieces / unit		€
441608/011	red	1 pack	1 / pack	1/90	

## Fence Connection Cable, triple

- Cable length: 2 x 60 cm
- Connecting parts made from stainless steel
- with 3 crocodile clips

Connecting parts made from stainless steel



Ref. no.	Colour	Pieces / unit		€
441601/011	red	1 / pack	1/40	

## Crocodile Clip

- as replacement crocodile clip
- Connecting parts made from stainless steel
- insulated handle

Connecting parts made from stainless steel

Ref. no.	Colour		€
443039	red	1/10/200	
443040	green	1/10/200	

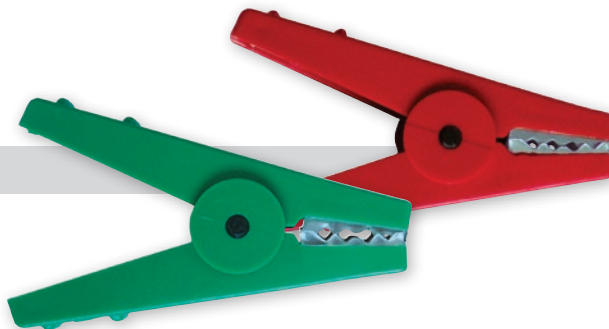

## Ground Connection Cable

- connects fencer and ground rod
- with two M8 metal eyelets
- Cable length: 100 cm

100 cm



Ref. no.	Colour	MOQ	Pieces / unit		€
44604/011	green	1 pack	1 / pack	1/90	

## Fence Connector Cable Heart Clip

- connects fencer and wire or poly wire
- reinforced, thick cable design with sturdy connection to eyelet and terminal
- Connecting parts made from stainless steel
- with heart clip, with M8 metal eyelet
- Cable length: 125 cm

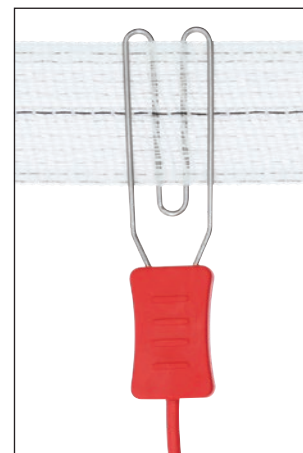
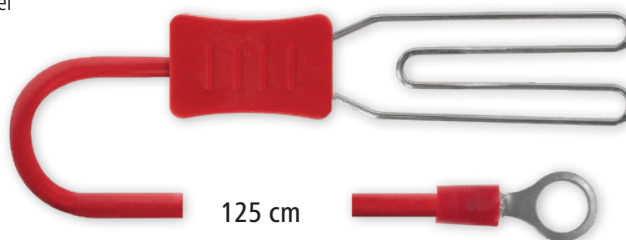

Ref. no.	can be used for		€
443046/011	Rope, Tape	1/90	

## Rope Connecting Cable

- ideal mechanical and electrical connection between energizer and fencing rope
- with M8 metal eyelet
- Cable length: 150 cm



Ref. no.	Colour	can be used for	Pieces / unit		€
44627/011	red	rope up to Ø 6.5 mm	1 / pack	1/90	

## Rope Connector

- ideal mechanical and electrical connection between two fencing ropes
- Cable length: 80 cm

80 cm





Ref. no.	Colour	can be used for	MOQ	Pieces / unit		€
44629/011	red	rope up to Ø 6.5 mm	1 pack	1 / pack	1/90	

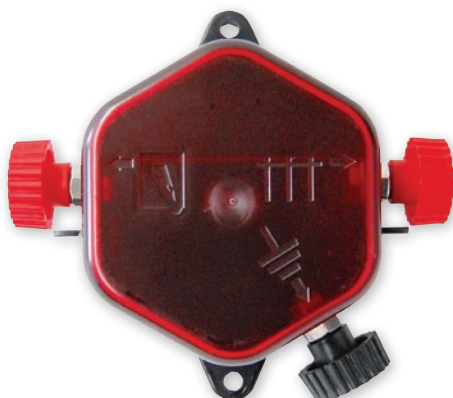

## Lightning Protection

- protect your electric fence unit from over-voltage caused by lightning strikes to the fence
- for mounting on a fence post
- the 'lightning protection' takes the over-voltage from the fence directly into the ground through a fixed spark gap
- for mobile battery units
- screw in or nail on
- Material: Plastic



Ref. no.	Pieces / unit		€
449602/011	1 / pack	1	

## Cut-Out Switch

- practical on/off and changeover switch for your fence system
- ideal also for mains operated fence lines
- switches two separate fence systems



4 items possible

I	fence 1 only
II	
I + II	Fence 1 + 2 together
0	Off

Ref. no.	MOQ	Pieces / unit		€
44607	1 pouch	1 / pouch	1/20	
44607/011	1 pack	1 / pack	1	

## Lightning protection device

- protect your electric fence unit against overvoltage that can be caused by lightning strikes to the fence system
- consisting of lightning protection choke and spark gap
- screw-on fastening
- Material: galvanised metal



To prevent lightning damage, a lightning protection device (with choke and spark gap) must be installed on non-combustible material on the outside of the building before a fence supply line is introduced into a building.

The lightning protection device must not be connected to the operating earth on the electric fence device.

If a building lightning protection device is present, the earth wire of the lightning protection device should be connected to the earth on this system. Otherwise, a separate earthing system is needed for the lightning protection device.

Ref. no.		€
44601	1/10	



**Top Seller**

## High-power on/off switch

- extremely sturdy on/off switch for your fence system
- easy assembly on posts



Ref. no.		€
591226	1/25	



## Customised warning signs

You can have warning signs made to your specifications from a minimum order of just 500 units. Simply get in touch and let us supply your motif and desired text. We will create a design and make your custom signs soon after you give your approval.

Extract from the safety standard: Each part of an electric fence that is installed along a public road or pathway must be identified by warning signs at frequent intervals. These must be securely fastened to the fence or firmly clamped to the fence wires.



## Warning Sign – Caution Electric Fence!

- for easy hanging in strips of up to 40 mm, ropes, poly wires and wires
- no further fastening material required
- Material: Plastic
- printed on both sides



Top Seller



Ref. no.	Colour	Length	Width		€
446513	yellow	26 cm	15 cm	1/10/100	

## Warning Sign – Caution Electric Fence!

- Material: Plastic
- printed on both sides



Ref. no.	Print	Colour	Length	Width		€
44620	„Caution Electric Fence!“	yellow	20 cm	12 cm	1/10/250	

## Warning Sign

- Material: Plastic
- printed on one side



Available in customer-specific composition.

Ref. no.	Print	Colour	Length	Width		€
44621	“Do not feed.”	yellow	20 cm	12 cm	1/25/250	
44628	“No trespassing.”	yellow	20 cm	12 cm	1/25/400	
446510	„Caution – bull in field.“	yellow	20 cm	12 cm	1/25/500	

## Warning Sign – Electric Fence

- display on public footpaths
- Material: Plastic
- printed on both sides





Ref. no.	Print	Colour	Length	Width		€
44623	Electric fence	yellow	20 cm	10 cm	1/50/500	

## One-Hand Drop Aid

- one-handed unrolling of conductor material – allows the conductor material to be attached to the insulators at the same time
- for spools of up to 250 mm height and/or weighing up to 3 kg



conductor material not included

Ref. no.	Colour	Material			€
442368	black	Plastic	1/50	900	

## Plastic Reel Super

- very hardwearing plastic reel (replaceable)
- locking pin prevents reel from accidental reeling on
- the ideal aid for fence building
- Drum mounting: with cotter pin





Locking pin



442705  
Roll-up Adapter



Ref. no.	Colour	can be used for		€
44270	black	600 m tape (10 mm), 500 m rope (6 mm), 1,000 m Poly wire (3 mm)	1	

Ref. no.	Description	Colour	Material		€
44271	Replacement Drum	black	Plastic	1	
44272	Frame		metal	1/25	
442705	Roll-up Adapter Easy-Drill	red	Plastic	1/20	

## Reel Super Big

- extra-wide design
- locking pin prevents reel from accidental reeling on
- Drum mounting: with cotter pin



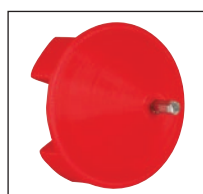

Locking pin



442705  
Roll-up Adapter



Ref. no.	Colour	can be used for		€
441270	black	1,200 m tape (10 mm), 1,000 m rope (6 mm), 2,000 m Poly wire (3 mm)	1	

Ref. no.	Description	Colour	Material		€
441272	Frame for Reel Super BIG		metal	1	
442705	Roll-up Adapter Easy-Drill	red	Plastic	1/20	
441271	Replacement Drum Super Big	black	Plastic	1	



## Euro Reel

- metal hook allows fast electrification of the conductor material on the reel!
- with metal hook
- Drum mounting: with linch pin

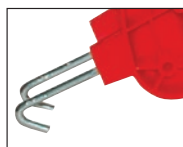

Metal Hook



Top Seller

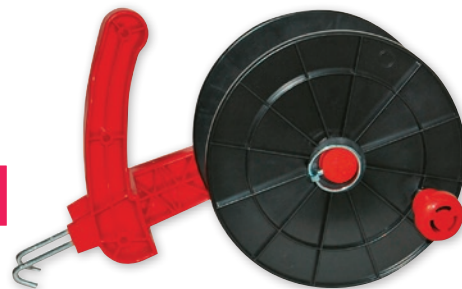

Ref. no.	Colour	drum ø	can be used for		€
441041	black / red	18 cm	200 m tape (10 mm), 200 m rope (6 mm), 500 m Poly wire (3 mm)	1/5	

Ref. no.	Description	Colour		€
441201	Replacement Drum for Euro Reel	black	1/10	

## Poly Wire on Reel

the popular Euroreel (441041) already loaded with 300 m of polywire

Tedious winding of the wire material is dispensed with and the reel is ready for use immediately



Ref. no.	Length	Colour	max. recommended fence length	Resistance	Number of conductors	Stainless Steel Ladder	Tin-plated copper conductor	Break load			€
449597	300 m	white / black	6,000 m	0.3 Ω/m	6	5 x 0,2 mm	1 x 0,25 mm	100 kg	1/6	120	

## Euro Reel Eco

- with plastic hook
- Drum mounting: with linch pin



441040-RE: manufactured from recycled plastic to the same quality standard

Ref. no.	Colour	drum ø	can be used for		€
441040	black	18 cm	200 m tape (10 mm), 200 m rope (6 mm), 500 m Poly wire (3 mm)	1/5	
441040-RE	anthracite	18 cm	200 m tape (10 mm), 200 m rope (6 mm), 500 m Poly wire (3 mm)	1/5	

Ref. no.	Description	Colour		€
441201	Replacement Drum for Euro Reel	black	1/10	

## Euro Reel Big

- metal hook allows fast electrification of the conductor material on the reel!
- Drum mounting: with linch pin

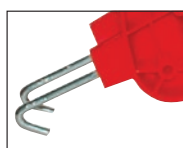

Metal Hook

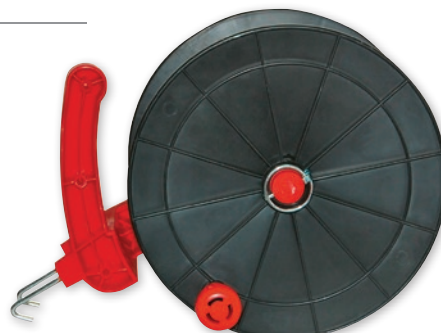

Ref. no.	Colour	drum ø	can be used for		€
441042	black / red	24 cm	400 m tape (10 mm), 400 m rope (6 mm), 800 m Poly wire (3 mm)	1/5	

Ref. no.	Description	Colour		€
441206	Replacement Drum for Euro Reel Big	black	1/10	

## Super plastic reel with handle and holder for mounting on stands

- flexible solution for quickly pulling single-row mobile fences
- can be converted very easily and without tools into a reel system for mobile fence construction in combination with a galvanised reel stand (44266)
- incl. spring mechanism for locking the reel
- easy winding and unwinding of wire, rope and tape
- locking pin prevents reel from accidental reeling on

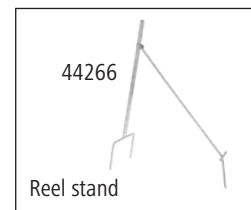

Reel stand



Roll-up Adapter

Ref. no.	can be used for		€
44267	600 m tape (10 mm), 500 m rope (6 mm), 1,000 m Poly wire (3 mm)	1	

Ref. no.	Description	Colour	Material		€
44266	Reel stand tripod			1	
442705	Roll-up Adapter Easy-Drill	red	Plastic	1/20	
44271	Replacement Drum	black	Plastic	1	

## Compact Reel

- impact-proof plastic guarantees durable use
- special eye for well-directed wire routing
- heavy-duty steel crank arm
- galvanized carry handle for manual use or for clipping into the portable reel system
- with locking ratchet
- holder for clasps (44298) not included in the scope of delivery
- for hanging in the post reel system
- Drum mounting: with locknut



Ref. no.	Colour	can be used for		€
44296	black	200 m tape (40 mm), 600 m Poly wire (3 mm)	1	

## Geared Reel 3:1

- save time by 3-way transmission
- special eye for well-directed wire routing
- impact-proof plastic guarantees durable use
- heavy-duty steel crank arm
- with reliable fixing locknut
- for hanging in the post reel system

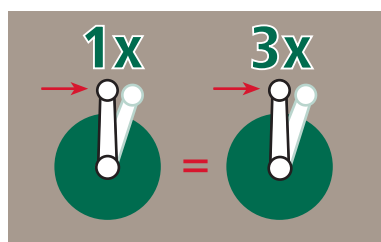

Ref. no.	Colour	can be used for		€
44274	grey	200 m tape (40 mm), 600 m Poly wire (3 mm)	1	



# Post reel systems for temporary fencing

## Multi Post

- the ideal solution for corner and gate systems for mobile fencing (plastic, metal)
- holder for clasps (44298) not included in the scope of delivery

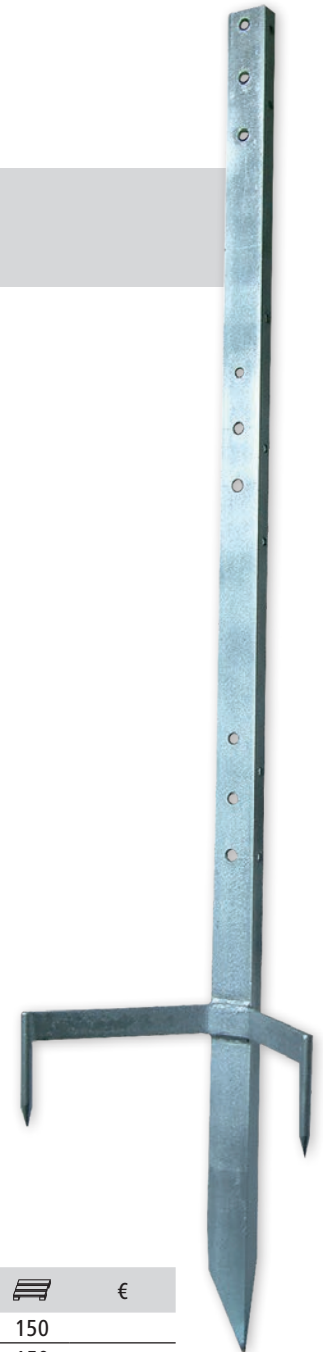
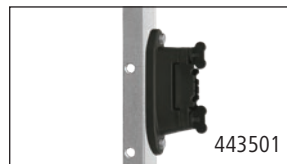
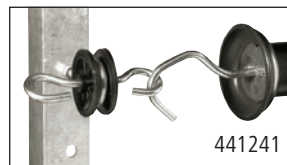
A perfect professional reel system for temporary fencing systems that have to be assembled and disassembled quickly and for many years of use. The indispensable aid for modern fencing.



Ref. no.	Description	Total height	Material thickness			€
44297	for max. 3 reels	120 cm	4 mm	1	150	
44299	for max. 4 reels	165 cm	4 mm	1	150	

Ref. no.	Description	Colour	Material	MOQ	Pieces / unit		€
44324	Ring Insulator for metal post	black	Plastic	1 pouch	25 / pouch	1/25/500	
441360	Corner insulator Premium	black	Polyamide	1 pouch	10 / pouch	1/10/250	
441241	Gate / start insulator	black	Plastic	1 pouch	10 / pouch	1/10/250	
44298	Reel Holder		galvanised metal			1/50	
44355/041	Gate / start insulator for tapes Premium	black	Plastic	1 pack	4 / pack	1/22	
443501	Corner/Stretch Insulator Premium	black	Plastic	1 pouch	10 / pouch	1/10/200	

## Reel Holder

- attaches reel
- with a plastic clamping screw
- Material: galvanised metal
- for hanging reels 44274 and 44296

Ref. no.		€
44298	1/50	

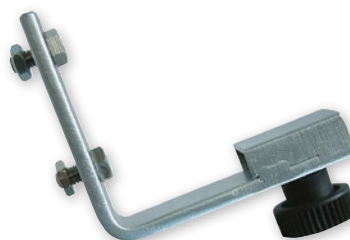



# What kind of conductor material do I need?

There are several points to take into account when selecting the right conductor material. In principle, you have a choice between conductor materials made of plastic (tapes, wires, ropes) in which the current-carrying wires are interwoven with plastic threads, and solid wires made of carbide, which are especially suitable for constructing permanent fences.

When selecting the right wire material, note the resistance in Ohm/m. The lower this value, the better the material conducts electricity. Our proven TriCond material combines high conductivity with a long service life.

You can find all this information on our packaging:



## Resistance in Ohm/m:

the lower this value, the better the material conducts electricity.

## Maximum fence length:

the lower the resistance in Ohm/m, the longer the fences that can be built. In practice, however, this requires low vegetation, excellent insulators and an optimised earthing system.

$$\text{Fence length} = \text{single fence length} \times \text{number of rows}$$

## Break load:

specifies the max. tensile load in kg before the material tears.

## Number and material of the conductors:

provides information regarding the conductor specification used. More conductors and a larger diameter result in a lower resistance and therefore higher conductivity.

### Fence tape

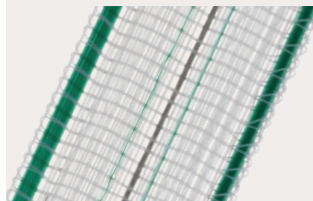

### Fence rope



### Polywire



Resistance to weather



Visibility



Easy to install



Hard-wearing



We divide our conductor materials into the following quality levels:



**AKO expert tip:** The lower the resistance in  $\Omega/m$ , the better the conductivity.

**Premium**

PremiumLine & Platinum Line  
0 - 50 km

5 year UV stability warranty



### AKO PlatinumLine series

- Excellent conductivity and resilience
- Ideal for very long fence systems
- especially robust thanks to extra-strong material combination

- Made in Germany

### AKO PremiumLine series

- Excellent conductivity and durability
- Area of use: long to very long fences



~ 0,05-0,25 Ohm/m

**Expert**

TopLine  
0 - 10 km

4 year UV stability warranty



### AKO TOPLine series

- Optimised price/performance ratio. The lower-cost version with excellent conductivity.
- Area of use: medium to long fences



~ 0,2-0,6 Ohm/m

**Classic**

EconomyLine  
0 - 500 m

3 year warranty of UV stability



### AKO EconomyLine series

- The affordable solution!
- Area of use: ideal for short fences, smaller paddocks and temporary sections



> 1,0 Ohm/m



**Litzclip**



If a crack should appear in your conductor material, you can repair the problem area very quickly and easily with suitable connectors. We recommend using our patented Litzclip connectors, which allow the damaged areas to be effortlessly reconnected again without any tools. Under no circumstances should conductor material be knotted, as in this case the fine conductor wires would not lie perfectly on top of each other and so a sufficient current flow could not be guaranteed.



# PlatinumLine

Made in Germany

PlatinumLine products feature outstanding robustness and durability. With particularly high-quality reinforced monofilaments and extended conductor diameters, they fulfil the highest demands in terms of breaking strength and conductivity. These conductor materials are perfect for long fences and livestock requiring special protection.

## Tape PlatinumLine

The PlatinumLine fence tape with extra-thick monofilament threads, reinforced outer edges and tin-plated copper wires offers maximum protection and is particularly durable.

- the ideal combination of the best conductivity and increased breaking load combined in one conductor material
- extra-thick monofilaments and reinforced outer edges ensure excellent breaking strength and longevity
- maximum conductivity and protection thanks to the use of thick, galvanised copper wires



Made in Germany



5 year UV stability warranty





442828:

- 2 x 200 m length in twin pack
- practical double pack with TOP price/performance ratio



We generally recommend the use of stainless steel accessories (connectors, fittings, gate handles)

Ref. no.	Length	Width	Colour	max. recommended fence length	Resistance	Number of conductors	Stainless Steel Ladder	Tin-plated copper conductor	Break load	 	€
442820	200 m	12.5 mm	white / blue	13 km	0.16 Ω/m	5	3 x 0,2 mm	2 x 0,25 mm	80 kg	1 240	
442821	200 m	20 mm	white / blue	18 km	0.11 Ω/m	6	3 x 0,2 mm	3 x 0,25 mm	180 kg	1 144	
442822	200 m	40 mm	white / blue	30 km	0.06 Ω/m	10	6 x 0,2 mm	4 x 0,25 mm	450 kg	1 60	
442828	400 m	12.5 mm	white / blue	13 km	0.16 Ω/m	5	3 x 0,2 mm	2 x 0,25 mm	80 kg	1 120	NEW





## Rope PlatinumLine

Conductive, robust and safe - our fence rope combines excellent conductivity with outstanding durability. With its proven braiding, conductor wires in continuous contact on the outside and its extra-thick copper wires, it provides optimum contact and safety for your animals.

- the ideal combination of the best conductivity and increased breaking load combined in one conductor material
- because of its smooth surface, the rope is particularly easy to work and can be used everywhere
- proven braiding for maximum stability and durability with improved elasticity
- the conductor wires continuously attached on the outside guarantee optimum contact at all times
- extra thick tin-plated copper wires in combination with stainless steel conductors ensure maximum conductivity and animal safety

Made in Germany



5 year UV stability warranty



woven and therefore extremely robust and resilient



Ref. no.	Length	Ø	Colour	max. recommended fence length	Resistance	Number of conductors	Stainless Steel Ladder	Tin-plated copper conductor	Break load		€
442824	200 m	6 mm	white / blue	35 km	0.05 Ω/m	12	8 x 0,2 mm	4 x 0,25 mm	450 kg	1	120
442825	500 m	6 mm	white / blue	35 km	0.05 Ω/m	12	8 x 0,2 mm	4 x 0,25 mm	450 kg	1	48

## Poly Wire PlatinumLine

Conductive, robust and safe - our polywire combines excellent conductivity with an increased breaking load. With its unique braiding, continuous surface conductor wires and extra-thick copper wires, it offers optimum contact and safety for your animals.

- the ideal combination of the best conductivity and increased breaking load combined in one conductor material
- unique braiding for maximum stability and durability with improved elasticity
- the conductor wires running continuously on the surface guarantee optimum contact at all times
- extra-thick copper wires ensure high conductivity and protection

Made in Germany



5 year UV stability warranty



442829:  
 • 2 x 300 m length in twin pack  
 • practical double pack with TOP price/performance ratio

woven and therefore extremely robust and resilient



We generally recommend the use of stainless steel accessories (connectors, fittings, gate handles)

Ref. no.	Length	Colour	max. recommended fence length	Resistance	Number of conductors	Stainless Steel Ladder	Tin-plated copper conductor	Break load		€
442823	300 m	white / blue	30 km	0.06 Ω/m	10	6 x 0,2 mm	4 x 0,25 mm	120 kg	1	240
442827	1,000 m	white / blue	30 km	0.06 Ω/m	10	6 x 0,2 mm	4 x 0,25 mm	120 kg	1	96
442829	600 m	white / blue	30 km	0.06 Ω/m	10	6 x 0,2 mm	4 x 0,25 mm	120 kg	1	120

NEW

# Fencing Tape Premium



The new generation of connectors: tool-free, fast, reliable „Simple but perfect!“

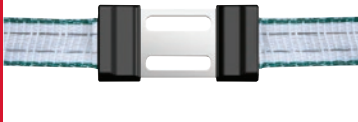

We generally recommend the use of stainless steel accessories (connectors, fittings, gate handles)

## Tape PremiumLine

AKO PremiumLine tapes guarantee the highest conductivity and best tending safety, even on very long runs of fence. The use of thick tin-plated copper conductors means that conductivity is 40 x higher than that achieved by traditional conductor materials.

**Z-webbing** = cross connected wires guarantee permanent re-electrification and thus constant power flow

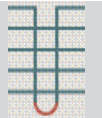

**Wire grouping** = there is a link of two live wires to keep the fence voltage at a constant level

**reinforced outer edges** = high tear resistance

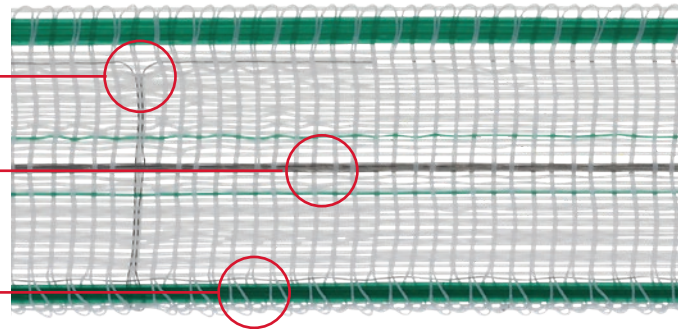

Ref. no.	Length	Width	Colour	max. recommended fence length	Resistance	Number of conductors	Stainless Steel Ladder	Tin-plated copper conductor	Break load			€
441533	200 m	12.5 mm	white / green	7.5 km	0.25 Ω/m	5	3 x 0,2 mm	2 x 0,2 mm	80 kg	1/12	144	
441534	200 m	20 mm	white / green	11.5 km	0.17 Ω/m	6	3 x 0,2 mm	3 x 0,2 mm	180 kg	1/6	120	
441535	200 m	38 mm	white / green	15 km	0.13 Ω/m	10	6 x 0,2 mm	4 x 0,2 mm	270 kg	1/6	48	







## Tape Premium Plus

AKO Premium Plus tapes guarantee maximum robustness and durability. The particularly strong monofilament fibres and the expanded diameters of our TriCOND™ conductor material fulfil the highest requirements when it comes to breaking load and conductivity.

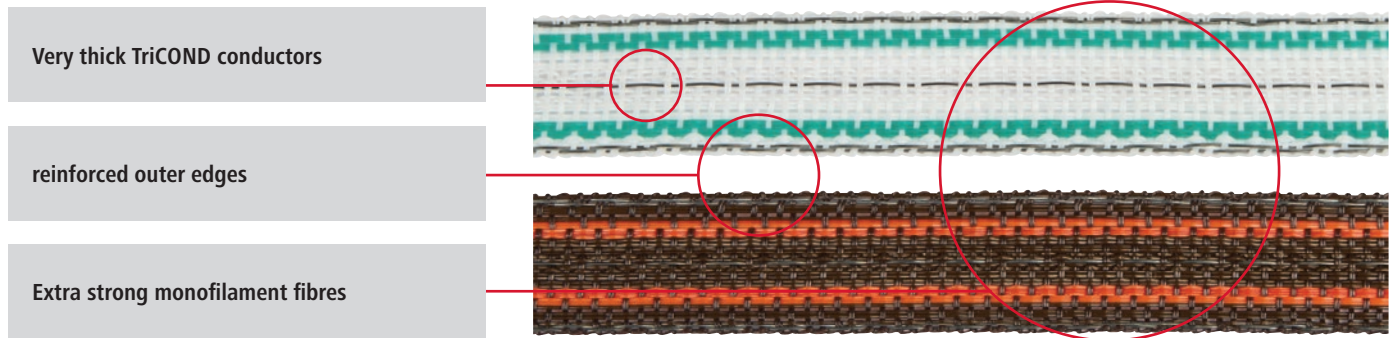

Ref. no.	Length	Width	Colour	max. recommended fence length	Resistance	Number of conductors	TriCond Conductor	Break load			€
449123	200 m	20 mm	brown / orange	11 km	0.183 Ω/m	5	0,4 mm	190 kg	1/6	96	
449124	200 m	20 mm	white / green	11 km	0.183 Ω/m	5	0,4 mm	190 kg	1/6	96	
449122	200 m	40 mm	brown / orange	22 km	0.09 Ω/m	10	0,4 mm	350 kg	1/4	48	
449125	200 m	40 mm	white / green	22 km	0.09 Ω/m	10	0,4 mm	350 kg	1/4	48	







4 year UV stability warranty



## Tape TopLine Plus

AKO TopLine PLUS Tapes guarantee excellent conductivity and longevity for medium to long fences. Thanks to the use of our tried-and-tested TriCOND conducting material, compared to rust-proof wires of the same thickness, the tapes, wires and ropes in the TopLine Plus range boast 5 x higher conductivity. In other words, you can use 5 x longer fences or, 'transport' 5 x more power to areas in contact with animals = 5 x more security

TriCOND conductor wires have been extensively tested over the last few years and have shown to have a long lifetime. The low resistance of TriCOND wires and the associated high tending safety result in an excellent price / performance ratio. A comparison is worthwhile (resistance in ohm/ metre in relation to the price).

**New TriCOND conductor** = excellent conductivity and long service life

**Strong monofilament fibres** = increased fracture load

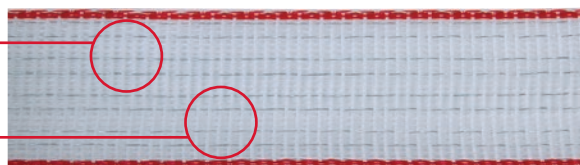

Ref. no.	Length	Width	Colour	max. recom- mended fence length	Resistance	Number of conductors	TriCond Con- ductor	Break load			€
4491504	200 m	10 mm	white / red	4 km	0.467 Ω/m	4	0,3 mm	90 kg	1/12	240	
4491505	500 m	10 mm	white / red	4 km	0.467 Ω/m	4	0,3 mm	90 kg	1/6	120	
449568	200 m	10 mm	yellow / orange	4 km	0.467 Ω/m	4	0,3 mm	90 kg	1/12	240	
449566	200 m	10 mm	orange	5 km	0.374 Ω/m	5	0,3 mm	90 kg	1/12	240	
449569	200 m	10 mm	blue	5 km	0.374 Ω/m	5	0,3 mm	90 kg	1/12	240	
449567	200 m	10 mm	yellow	5 km	0.374 Ω/m	5	0,3 mm	90 kg	1/12	240	
449550	400 m	20 mm	white / red	5 km	0.374 Ω/m	5	0,3 mm	120 kg	1/6	60	
449551	200 m	20 mm	white / red	5 km	0.374 Ω/m	5	0,3 mm	120 kg	1/12	120	
449563	200 m	20 mm	yellow / orange	5 km	0.374 Ω/m	5	0,3 mm	120 kg	1/12	120	
449570	200 m	20 mm	blue	6 km	0.311 Ω/m	6	0,3 mm	120 kg	1/12	120	
449108	200 m	20 mm	green	5 km	0.374 Ω/m	5	0,3 mm	120 kg	1/12	120	
449554	200 m	40 mm	white / red	10 km	0.187 Ω/m	10	0,3 mm	230 kg	1/6	72	
449109	200 m	40 mm	green	10 km	0.187 Ω/m	10	0,3 mm	230 kg	1/6	48	
449553	200 m	40 mm	brown	10 km	0.187 Ω/m	10	0,3 mm	230 kg	1/6	72	

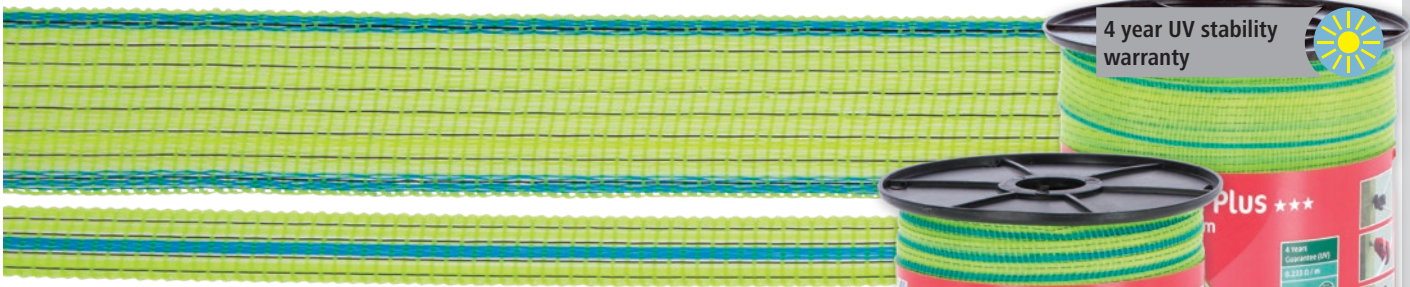

4 year UV stability warranty



## Tape TopLine Plus

- high conductivity and long-term durability for medium-sized to long fence systems



30 mm wide as an ideal compromised between visibility and wind susceptibility

especially good visibility due to luminous neon colours (fluorescent effect)

Ref. no.	Length	Width	Colour	max. recommended fence length	Resistance	Number of conductors	TriCond Conductor	Break load			€
449582	200 m	12 mm	neon yellow / blue	4 km	0.467 Ω/m	4	0,3 mm	90 kg	1/12	288	
449583	200 m	30 mm	neon yellow / blue	8.5 km	0.233 Ω/m	8	0,3 mm	230 kg	1/6	96	



4 year UV stability warranty



## Tape TopLine

Ref. no.	Length	Width	Colour	max. recommended fence length	Resistance	Number of conductors	TriCond Conductor	Break load			€
449598	200 m	20 mm	white / petrol	5 km	0.39 Ω/m	6	0,25 mm	120 kg	1/12	120	
449599	200 m	20 mm	white / pink	5 km	0.39 Ω/m	6	0,25 mm	120 kg	1/12	120	



## Tape EconomyLine

- plastic made from recycled material with same quality standard
- ideal for short fence lines and strip grazing areas
- sustainable, resource-sparing packaging

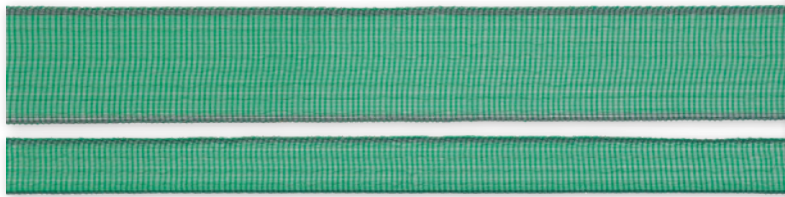

3 year warranty of UV stability



Standard fence tapes for short fence lines and strip grazing areas

Ref. no.	Length	Width	Colour	max. recommended fence length	Resistance	Number of conductors	Stainless Steel Ladder	Break load			€
442811-RE	200 m	20 mm	green / grey	200 m	10.47 Ω/m	4	0,16 mm	90 kg	1/12	216	
442812-RE	200 m	40 mm	green / grey	400 m	5.23 Ω/m	8	0,16 mm	130 kg	1/6	96	

## Tape EconomyLine

- ideal for short fence lines and strip grazing areas



3 year warranty of UV stability



Standard fence tapes for short fence lines and strip grazing areas

Ref. no.	Length	Width	Colour	max. recommended fence length	Resistance	Number of conductors	Stainless Steel Ladder	Break load			€
44550	200 m	12.5 mm	white	200 m	10.47 Ω/m	4	0,16 mm	75 kg	1/12	240	
44556	200 m	20 mm	white	200 m	10.47 Ω/m	4	0,16 mm	90 kg	1/12	240	
44557	200 m	40 mm	white	400 m	5.23 Ω/m	8	0,16 mm	130 kg	1/6	96	

## Fencing Tape Double Pack EconomyLine

- 2 x 200 m length in twin pack

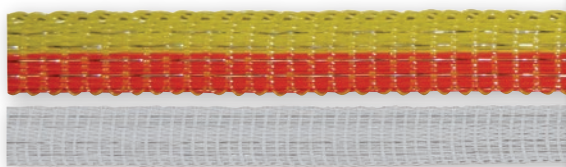

3 year warranty of UV stability



Standard fence tapes for short fence lines and strip grazing areas

Ref. no.	Length	Width	Colour	max. recommended fence length	Resistance	Number of conductors	Stainless Steel Ladder	Break load			€
44565	400 m	10 mm	yellow / orange	200 m	10.47 Ω/m	4	0,16 mm	60 kg	1/6	120	
441525	400 m	10 mm	white	200 m	10.47 Ω/m	4	0,16 mm	60 kg	1/6	120	





The new generation of connectors: tool-free, fast, reliable „Simple but perfect!“



**Top Seller**

5 year UV stability warranty



We generally recommend the use of stainless steel accessories (connectors, fittings, gate handles)



## Rope PremiumLine

AKO PremiumLine ropes guarantee the highest conductivity and best tending safety, even on very long runs of fence.



- thick tin-plated copper conductors – the copper conductors mean that conductivity is 40 times higher than that achieved by traditional conductor materials
- stable stainless steel conductors - ensure a long service life

wire grouping = permanent electrification

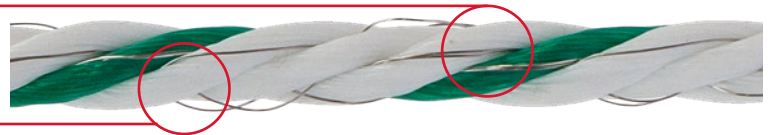

extra-strong monofilament fibres = increased fracture load

Ref. no.	Length	Ø	Colour	max. recommended fence length	Resistance	Number of conductors	Stainless Steel Ladder	Tin-plated copper conductor	Break load			€
441564	200 m	6.5 mm	white / green	20 km	0.1 Ω/m	9	6 x 0,2 mm	3 x 0,25 mm	400 kg	1/4	72	
441554	400 m	6.5 mm	white / green	20 km	0.1 Ω/m	9	6 x 0,2 mm	3 x 0,25 mm	400 kg	1/2	36	
441519	400 m	6.5 mm	orange / brown	20 km	0.1 Ω/m	9	6 x 0,2 mm	3 x 0,25 mm	400 kg	1/2	36	

## Rope Premium Light

Premium quality at a good price-performance ratio: The highest conductivity and durability through our proven combination of thick tinned copper conductors and robust stainless steel wires at an affordable promotional price.

- increased fracture load thanks to strong monofilament wires
- ideal for long to very long fences

We generally recommend the use of stainless steel accessories (connectors, fittings, gate handles)



Ref. no.	Length	Ø	Colour	max. recommended fence length	Resistance	Number of conductors	Stainless Steel Ladder	Tin-plated copper conductor	Break load			€
441565	400 m	6 mm	white / blue	13 km	0.155 Ω/m	6	4 x 0,2 mm	2 x 0,25 mm	350 kg	1/2	48	

TriCOND conductor wires have been extensively tested over the last few years and have shown to have a long lifetime. The low resistance of TriCOND wires and the associated high tending safety result in an excellent price / performance ratio. A comparison is worthwhile (resistance in ohm/metre in relation to the price).



## Rope TopLine Plus

The AKO TopLine Plus Rope combines long service and durability with excellent conductivity to create a product that offers top value for money!

- Braided structure allows the conductor wires to run continuously on the surface and thus enables optimum contact with animals
- high number of TriCOND conductors means very good conductivity in combination with long durability
- Robust plastic fibre core for maximum durability and resistance
- Strands of cross-braided PE monofilaments ensure a very high break load with improved elasticity and water-resistant properties



4 year UV stability warranty



New product

NEW



woven and therefore extremely robust and resilient

Ref. no.	Length	Ø	Colour	max. recommended fence length	Resistance	Number of conductors	TriCOND Conductor	Break load			€
449540	400 m	6 mm	white / red	10 km	0.2 Ω/m	9	0,3 mm	430 kg	1/2	48	

## Rope TopLine Plus

AKO TopLine Plus ropes guarantee excellent conductivity and long-term durability for medium-sized to long fence systems. Thanks to the use of our tried-and-tested TriCOND conducting material, compared to rust-proof wires of the same thickness, the tapes, wires and ropes in the TopLine Plus range boast 5 x higher conductivity. In other words, you can use 5 x longer fences or ,transport' 5 x more power to areas in contact with animals = 5 x more security





4 year UV stability warranty



strong PE monofilament fibres = increased break load

TriCOND Conductor = excellent conductivity and long service life



Ref. no.	Length	Ø	Colour	max. recommended fence length	Resistance	Number of conductors	TriCOND Conductor	Break load			€
449532	200 m	6 mm	white / red	6 km	0.311 Ω/m	6	0,3 mm	400 kg	1/6	96	
449531	400 m	6 mm	white / red	6 km	0.311 Ω/m	6	0,3 mm	400 kg	1/2	36	

## Rope EconomyLine

- plastic made from recycled material with same quality standard
- for shorter fence lines and strip-grazing areas
- sustainable, resource-sparing packaging

3 year warranty of UV stability



Standard fence ropes for short fence lines



Ref. no.	Length	Ø	Colour	max. recommended fence length	Resistance	Number of conductors	Stainless Steel Ladder	Break load		€
442815-RE	200 m	6 mm	green / grey	0.5 km	3.87 Ω/m	6	6 x 0,2 mm	350 kg	1/6 96	

## Rope EconomyLine

- sturdy polypropylene carrier material
- the economical alternative for small fence systems

Standard fence ropes for short fence lines



3 year warranty of UV stability



Ref. no.	Length	Ø	Colour	max. recommended fence length	Resistance	Number of conductors	Stainless Steel Ladder	Break load		€
44531	200 m	6 mm	white	0.5 km	3.87 Ω/m	6	0,2 mm	350 kg	1/6 96	
441545	500 m	6 mm	white	0.5 km	3.87 Ω/m	6	0,2 mm	350 kg	1/2 32	
44533	200 m	8 mm	white	0.5 km	3.87 Ω/m	6	0,2 mm	700 kg	1/2 48	

## Rope EconomyLine

Unique rope that offers sturdiness, efficiency and excellent visibility. The continual re-electrification of the two thick, highly conductive metal wires ensures maximum reliability. The interior PE monofilaments are UV resistant and extremely durable.

- ideal for horse and cattle paddocks

cross wound

Permanent re-electrification through crossing conductors

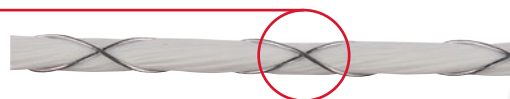

3 year warranty of UV stability



Ref. no.	Length	Ø	Colour	max. recommended fence length	Resistance	Number of conductors	Galvanised Iron Wire	Break load		€
441970	200 m	4 mm	white	6 km	0.35 Ω/m	2	0,5 mm	290 kg	1/6 120	



## Poly Wire Premium Ultra

- strands of cross-braided PE monofilaments ensure a very high break load with improved elasticity
- permanent re-electrification through conductor bundling and crossing conductors
- conductor wires continuously attached on the outside ensure optimal contact at the animal point of contact



5 year UV stability warranty



woven and therefore extremely robust and resilient

Cross-braided threads made from PE monofilaments = high break force with improved elasticity

6 stainless steel conductors and 3 copper conductors = maximum conductivity and bending stability



Ref. no.	Length	Ø	Colour	max. recommended length	Resistance	Number of conductors	Stainless Steel Ladder	Tin-plated copper conductor	Break load			€
441979	400 m	2.5 mm	white / green	20 km	0.1 Ω/m	9	6 x 0,2 mm	3 x 0,25 mm	110 kg	1/6	180	

## Poly Wire PremiumLine

AKO PremiumLine Wire guarantees maximum conductivity and herding safety, even for the longest of fences!

- strong PE threads - provide constantly high breaking strength on your fencing system
- thick tin-plated copper conductors – the copper conductors mean that conductivity is 40 times higher than that achieved by traditional conductor materials
- stable stainless steel conductors - ensure a long service life
- wire grouping - there is a link of two live wires to keep the fence voltage at a constant level.



5 year UV stability warranty



We generally recommend the use of stainless steel accessories (connectors, fittings, gate handles)

Thick PE filaments = Increased breaking load

Wire grouping = permanent electrification with constant high voltage



Ref. no.	Length	Colour	max. recommended fence length	Resistance	Number of conductors	Stainless Steel Ladder	Tin-plated copper conductor	Break load			€
441550	250 m	white / green	18 km	0.11 Ω/m	6	3 x 0,2 mm	3 x 0,25 mm	95 kg	1/12	240	
441551	500 m	white / green	18 km	0.11 Ω/m	6	3 x 0,2 mm	3 x 0,25 mm	95 kg	1/6	120	
441738	1,000 m	white / green	20 km	0.1 Ω/m	9	6 x 0,2 mm	3 x 0,25 mm	95 kg	1/2	72	

## Poly Wire Premium WildHog

- specially developed poly wire for deterring wild animals – the blue colour is especially easy to see for wild animals
- thick tin-plated copper conductors – the copper conductors mean that conductivity is 40 times higher than that achieved by traditional conductor materials



5 year UV stability warranty



Top Seller

**Blue signal colour** = increased visibility for wild animals

**6 stainless steel conductors and 3 copper conductors** = maximum conductivity and bending stability



Ref. no.	Length	Colour	max. recommended fence length	Resistance	Number of conductors	Stainless Steel Ladder	Tin-plated copper conductor	Break load		€
449312	400 m	blue	20 km	0.1 Ω/m	9	6 x 0,2 mm	3 x 0,25 mm	105 kg	1/6	120

## Poly Wire TopLine Plus

AKO TopLine Plus poly wires guarantee excellent conductivity and long-term durability for medium-sized to long fence systems. Thanks to the use of our tried-and-tested TriCOND conducting material, compared to rust-proof wires of the same thickness, the tapes, wires and ropes in the TopLine Plus range boast 5 x higher conductivity. In other words, you can use 5 x longer fences or ,transport' 5 x more power to areas in contact with animals = 5 x more security



4 year UV stability warranty



TriCOND conductor wires have been extensively tested over the last few years and have shown to have a long lifetime. The low resistance of TriCOND wires and the associated high tending safety result in an excellent price / performance ratio. A comparison is worthwhile (resistance in ohm/metre in relation to the price).

**TriCOND Conductor** = excellent conductivity and long service life

**strong PE monofilament fibres** = increased break load



Ref. no.	Length	Colour	max. recommended fence length	Resistance	Number of conductors	TriCond Conductor	Break load		€
449119	300 m	white / red	3 km	0.623 Ω/m	3	0,3 mm	100 kg	1/12	240
449523	400 m	white / red	7.5 km	0.26 Ω/m	9	0,25 mm	100 kg	1/6	144
449120	1,000 m	white / red	7.5 km	0.26 Ω/m	9	0,25 mm	100 kg	1	72
4491558	200 m	white / blue	6 km	0.311 Ω/m	6	0,3 mm	100 kg	1/12	360
4491559	400 m	white / blue	6 km	0.311 Ω/m	6	0,3 mm	100 kg	1/6	120

## Poly Wire EconomyLine

- plastic made from recycled material with same quality standard
- ideal for short fence lines and strip grazing areas
- sustainable, resource-sparing packaging

3 year warranty of UV stability



Ref. no.	Length	Colour	max. recommended fence length	Resistance	Number of conductors	Stainless Steel Ladder	Break load		€
442818-RE	250 m	green / grey	250 m	7.74 Ω/m	3	0,2 mm	120 kg	1/12 288	

## Poly Wire EconomyLine

- ideal for short fence lines and strip grazing areas

3 year warranty of UV stability



Ref. no.	Length	Colour	max. recommended fence length	Resistance	Number of conductors	Stainless Steel Ladder	Break load		€
441555	250 m	yellow / orange	250 m	7.74 Ω/m	3	0,2 mm	120 kg	1/12 288	
44520	250 m	yellow / orange	150 m	13.78 Ω/m	3	0,16 mm	60 kg	1/20 420	
44519	500 m	yellow / orange	150 m	13.78 Ω/m	3	0,16 mm	60 kg	1/12 288	

## Rope and wire tensioner

- for quick re-tensioning of ropes or wires in an existing fence course
- conductor material does not have to be cut for tensioning
- rotatable, rotating
- no further tool required



Ref. no.	Material	MOQ	Pieces / unit		€
442378	Plastic	1 pack	5 / pack	1/60	



## Polywire cross-wound EconomyLine

Unique poly wire that offers sturdiness, efficiency and excellent visibility. The continual re-electrification of the two thick, highly conductive metal wires ensures maximum reliability. The interior PE monofilaments are UV resistant and extremely durable.



3 year warranty of UV stability



Ref. no.	Length	Colour	max. recommended fence length	Resistance	Number of conductors	Galvanised Iron Wire	Break load			€
441972	200 m	white	6 km	0.35 Ω/m	2	0,5 mm	50 kg	1/12	360	
441973	400 m	white	6 km	0.35 Ω/m	2	0,5 mm	50 kg	1/8	288	

## Poly Wire Steuer

The ORIGINAL

- excellent tear resistance
- excellent conductivity thanks to 2 x 0.5 mm galvanised iron wires
- safe voltage transfer to the animal thanks to external metal wires throughout



3 year warranty of UV stability



Ref. no.	Length	Colour	max. recommended fence length	Resistance	Number of conductors	Galvanised Iron Wire	Break load			€
445025	500 m	transparent	6 km	0.35 Ω/m	2	0,5 mm	45 kg	1/8	200	
445035	1,000 m	transparent	6 km	0.35 Ω/m	2	0,5 mm	45 kg	1/4	120	

## Monowire EconomyLine

- 2 hot galvanised steel wires of 0.50 mm wrapped around 1 nylon core of 1.40 mm
- very good conductivity



3 year warranty of UV stability



Ref. no.	Length	Colour	max. recommended fence length	Resistance	Number of conductors	Galvanised Iron Wire	Break load			€
44502	500 m	transparent	6 km	0.35 Ω/m	2	0,5 mm	45 kg	1/8	192	
44503	1,000 m	transparent	6 km	0.35 Ω/m	2	0,5 mm	45 kg	1/4	120	

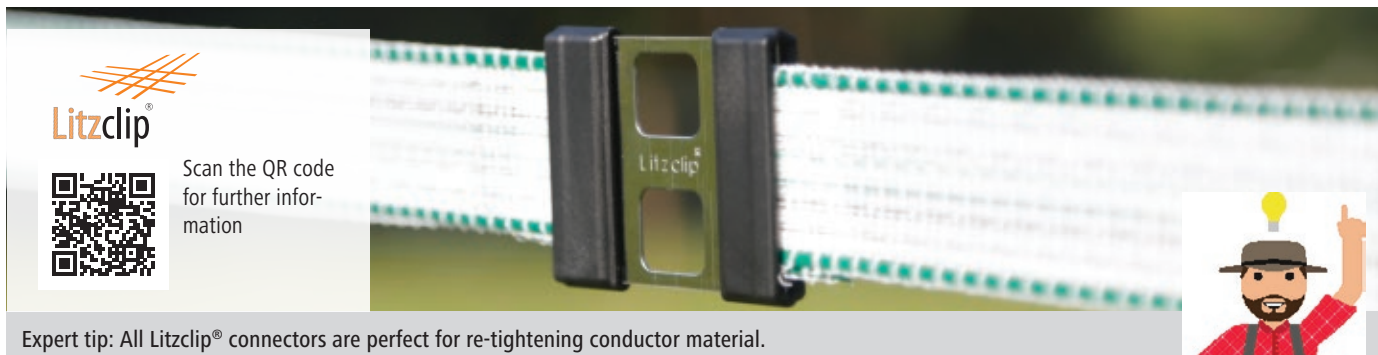

Expert tip: All Litzclip® connectors are perfect for re-tightening conductor material.

This is how it works:

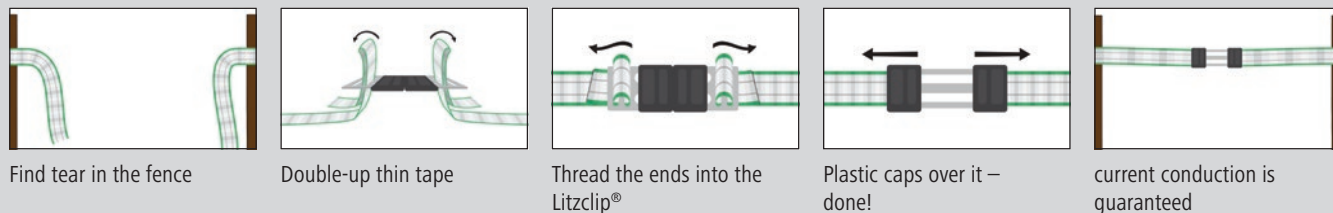

## Tape Connectors Litzclip®

- easy connection of 2 tape ends
- the quick solution for repairing torn fence tapes
- special narrow, punched rectangular openings for the easy introduction and securing of the tape

Made in Germany



patented

Ref. no.	Material	can be used for	MOQ	Pieces / unit		€
442000/051	stainless steel	tape up to 12.5 mm	1 pack	5 / pack	1/100	
442001/051	stainless steel	tape up to 20 mm	1 pack	5 / pack	1/100	
442002/051	stainless steel	tape up to 40 mm	1 pack	5 / pack	1/100	



## Tape Connectors

stainless steel

Ref. no.	Material	can be used for	MOQ	Pieces / unit		€
44594	stainless steel	tape up to 13 mm	1 pack	10 / pack	1/10/4000	
44595	stainless steel	tape up to 20 mm	1 pack	10 / pack	1/10/5000	
44596	stainless steel	tape up to 40 mm	1 pack	10 / pack	1/10/1250	



## Tape Connectors

galvanised

Ref. no.	Material	can be used for	MOQ	Pieces / unit		€
44570	steel, galvanised	tape up to 13 mm	1 pack	10 / pack	1/10/4000	
44573	steel, galvanised	tape up to 20 mm	1 pack	10 / pack	1/10/5000	
44573/056	steel, galvanised	tape up to 20 mm	1 pack	5 / pack	1	
44572	steel, galvanised	tape up to 40 mm	1 pack	10 / pack	1/10/1400	
44572/056	steel, galvanised	tape up to 40 mm	1 pack	5 / pack	1	





Scan the QR code for further information

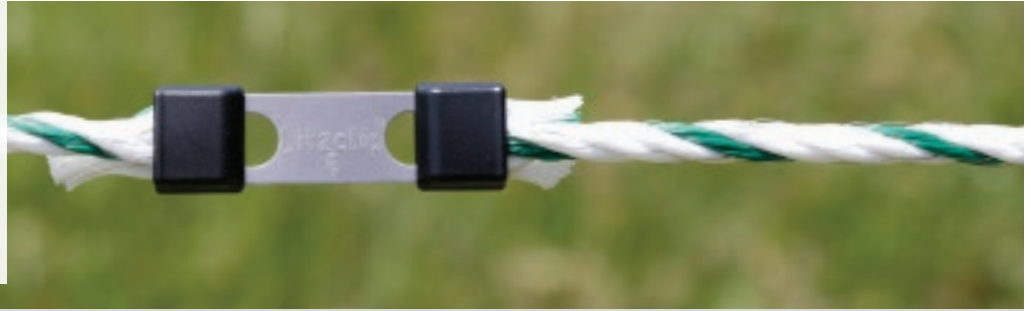

Expert tip: All Litzclip® connectors are perfect for re-tightening conductor material.

## Rope Connectors Litzclip®

- ideal for connecting 2 rope ends of up to 6 mm in diameter
- the quick solution for repairing a torn fence rope
- special key-shaped punched opening for the easy introduction and secure fixing of the rope

442016/106:

- Only while stocks last!



Made in Germany



patented



Ref. no.	Material	can be used for	MOQ	Pieces / unit		€
442004/051	stainless steel	rope up to Ø 6 mm	1 pack	5 / pack	1/100	
442016/106	steel, galvanised	rope up to Ø 5 mm	1 pack	10 / pack	1/100	



## Safety Link for Electric Rope Litzclip®

Electric rope opens at the rope break point in panic situations, reducing the risk of injury to your horse!



Made in Germany



**IMPORTANT: Reduced risk of injury for your horse, and also reduced pulling force on the rope!**

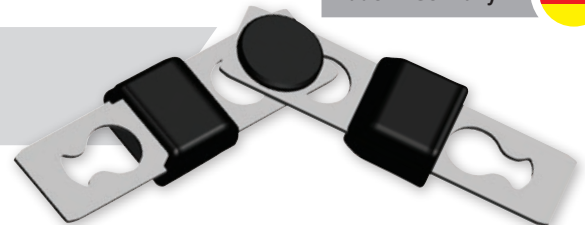

Included in delivery: 6 x Safety Link, 6 x Replacement Security Buttons

Ref. no.	Material	can be used for	MOQ	Pieces / unit		€
442008/061	stainless steel	rope up to Ø 6 mm	1 pack	6 / pack	1/100	

Ref. no.	Description	Colour	Material	MOQ	Pieces / unit		€
442009/066	Replacement security buttons	black	Plastic	1 pack	12 / pack	1/100	

## Poly Wire Connector Litzclip®

- the straightforward solution, even for repairing a torn poly wire
- special key-shaped punched opening for the easy introduction and secure fixing of the poly wire



Made in Germany



patented



Ref. no.	Material	can be used for	MOQ	Pieces / unit		€
442003/101	stainless steel	Poly wire up to Ø 3 mm	1 pack	10 / pack	1/100	





# Rope and Poly Wire Connectors

## Rope Connectors

galvanised

- safe mechanical and electrical connection
- easy installation as no tools are required thanks to the wing nut



New product

NEW



Ref. no.	Material	can be used for	MOQ	Pieces / unit		€
442354	galvanised metal	Rope 4/6/8 mm	1 pouch	10 / pouch	1/10/600	

## Rope Connectors

stainless steel



NEW: now with wing nuts

Ref. no.	Material	can be used for	MOQ	Pieces / unit		€
44540	stainless steel	Rope 4/6/8 mm	1 pouch	10 / pouch	1/10/100/400	
44540/051	stainless steel	Rope 4/6/8 mm	1 pack	5 / pack	1/50	

## Rope Connectors

galvanised





NEW: now with wing nuts

Ref. no.	Material	can be used for	MOQ	Pieces / unit		€
44535	galvanised metal	Rope 4/6/8 mm	1 pouch	10 / pouch	1/10/500	
44535/051	galvanised metal	Rope 4/6/8 mm	1 pack	5 / pack	1	

## Rope and Poly Wire Connectors

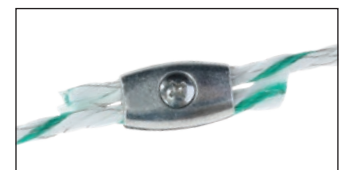
- safe mechanical and electrical connection
- easy to mount with a Philips screwdriver



Ref. no.	Material	can be used for	MOQ	Pieces / unit		€
441561	galvanised metal	Poly wire up to Ø 2.5 mm	1 pouch	10 / pouch	1/10/100/1200	
441561/051	galvanised metal	Poly wire up to Ø 2.5 mm	1 pack	5 / pack	1	
441560	galvanised metal	rope up to Ø 6.5 mm	1 pouch	10 / pouch	1/10/100/600	
441560/051	galvanised metal	rope up to Ø 6.5 mm	1 pack	5 / pack	1	



## Quick rope/poly wire connector

stainless steel



- allows ropes, wires and tapes of up to 10 mm to be connected to gate insulators and handles quickly and easily, resulting in a connection with optimal electrical conductivity
- made from stainless steel, guaranteeing excellent corrosion resistance
- no tools required



patented

stainless steel

The benefits: No need for tools, easy to create an optimum electrical connection using fixing screws. Also ideally suitable for retightening.



Ref. no.	Material	can be used for	MOQ	Pieces / unit		€
441285/041	stainless steel	Poly wire, rope up to Ø 8 mm, tape up to 10 mm	1 pack	4 / pack	1	

## Quick rope/poly wire connector

- allows ropes, wires and tapes of up to 10 mm to be connected to gate insulators and handles quickly and easily, resulting in a connection with optimal electrical conductivity
- no tools required



patented

The benefits: No need for tools, easy to create an optimum electrical connection using fixing screws. Also ideally suitable for retightening.

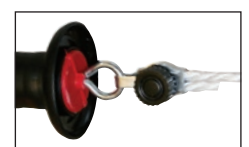

Ref. no.	Material	can be used for	MOQ	Pieces / unit		€
441209/041	galvanised metal	Poly wire, rope up to Ø 8 mm, tape up to 10 mm	1 pack	4 / pack	1	



# Permanent Fencing Accessories



Stationary fences are also characterised as permanent fencing and are used for several years as reliable security for your animals. This type of fence is especially low-maintenance because of the long-lasting and robust materials used in the construction of permanent fencing.

They are frequently built with recycled posts, metal T-posts and solid wood posts that are anchored deep into the ground. A stable construction is required, especially in corners and junctions, because of the high tensile forces on the material. Mobile fence variants also have their own conductor material. Here we recommend using our Premium Horse Wire (44873) or Special Steel Wire for fixed fences (445055). We have also developed practical de-tensioning and corner solution sets that make the construction of a stationary fence so much easier.

**Der Festzaun-Ratgeber für die Pferdekoppel**  
... Tipps und Tricks zum Selberbauen!



**Fixed fence guide**

Browse the new AKO fixed fence guide online or request your free copy by e-mail at [info@kerbl.com](mailto:info@kerbl.com)!









## Fence Wire ALU GUARD

- excellent conductivity, 4 times higher than conventional steel wire
- easy to handle during installation
- low weight (by 2/3 less than steel wire)
- increased breaking load through the addition of magnesium
- Material: Aluminium





Ref. no.	Length	Description	Ø	Resistance	Break load			€
445002	400 m	on a coil	1.6 mm	0.03 Ω/m	70 kg	1/4	168	
445007	400 m	on a coil	1.8 mm	0.023 Ω/m	90 kg	1/4	144	
445003	400 m	on a coil	2 mm	0.02 Ω/m	110 kg	1/4	120	

## Stranded Wire

- 7 strands
- increased breaking load through the addition of magnesium
- extremely flexible and light, therefore simpler and quicker to set up
- excellent conductivity, 4 times higher than conventional steel wire
- Material: Aluminium





Ref. no.	Length	Description	Ø	Resistance	Break load			€
445038	500 m	on a coil	1.8 mm	0.027 Ω/m	95 kg	1/4	120	

## Stranded Wire

- 7 strands
- very flexible, easy to install
- multi-use, e.g. for wildlife control
- Material: galvanised iron





Ref. no.	Length	Description	Ø	Resistance	Break load			€
44500	200 m	no reel	1.5 mm	0.12 Ω/m	200 kg	1	400	
445009	1,000 m	on a coil	1,5 mm	0.12 Ω/m	200 kg	1	60	

## Special Steel Wire for Fixed Fence

- zinc-aluminium-magnesium alloy as long-term protection
- ninefold protection against corrosion compared to galvanized wire
- extremely good conductivity
- ideal for permanent fence installations
- optimum current output upon animal contact
- Material: steel with zinc/aluminium/magnesium alloy
- 10-year guarantee

10-year guarantee 





Ref. no.	Length	Beschreibung	Ø	Resistance	Break load			€
445055	1,000 m	no reel	2 mm	0.06 Ω/m	345 kg	1	40	
44505	625 m	no reel	2.5 mm	0.035 Ω/m	650 kg	1	40	

## Iron Wire

- very good conductivity
- proven in fence construction for decades
- optimum current output upon animal contact
- Material: galvanised iron



Ref. no.	Length	Description	Ø	Resistance	Break load			€
445041	322 m	no reel	1.6 mm	0.07 Ω/m	95 kg	1/5	100	
44504	250 m	no reel	1.8 mm	0.05 Ω/m	110 kg	1/5	100	
445042	200 m	no reel	2 mm	0.04 Ω/m	140 kg	1/5	100	

## Wire Dispenser Vario

- trouble-free unrolling of permanent fencing wire
- robust square pipe design
- suitable for all wire coils or spools with an inner diameter of 30 - 85 cm
- steplessly adjustable
- easy tool-free assembly and disassembly, collapsible for transport
- additional ground plate prevents the wire dispenser sinking into soft ground



Ref. no.		€
442372	1	

## Wire Dispenser

- trouble-free unrolling of permanent fencing wire
- also suitable for Premium Horse Wire
- for floor mounting

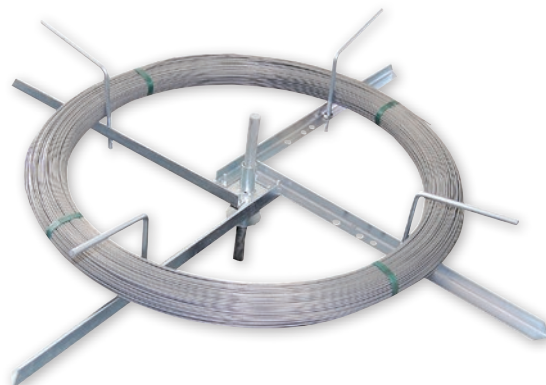

Ref. no.		€
441875	1/6	

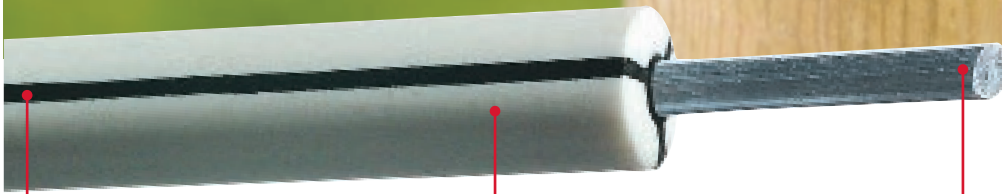

**Electrically conductive plastic**  
The steel wire is enclosed by a layer of electrically conductive carbon fibre plastic mix that reaches up to the surface through three lines.

**Polyethylene polymer**  
The area between the conductive material is surrounded by a sheath of white UV-stabilised polyethylene.

**Steel Wire**  
inside there is a special steel wire of 2.5 mm thickness

## Premium Horse Wire

Our most durable electrifiable horse fencing system! Premium Horse Wire provides a very strong mechanical barrier thanks to the 2.5 mm thick steel wire. The electrically conductive white/black plastic protects the interior steel wire from the weather and resists a breaking load of up to 800 kg. Its round shape and smooth surface mean cuts from the conductor material are avoided.

- great conductivity 0.035 Ohm/m
- high mechanical barrier due to steel wire (breaking strength 800 kg)
- electrifiable and very safe
- extremely weather-proof (cold, warmth, moisture)
- very good visibility due to high proportion of white and 8 mm diameter
- UV-Stabilised PE Covering
- lower physical hazard for horses due to round and smooth surface

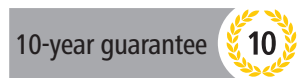

Tip: Use our 'Wire LINK' (442367) for connection



Ref. no.	Length	Ø	max. recommended fence length	Resistance	Break load			€
44873	250 m	8 mm	57 km	0.035 Ω/m	800 kg	1	20	



# Permanent Fencing Accessories

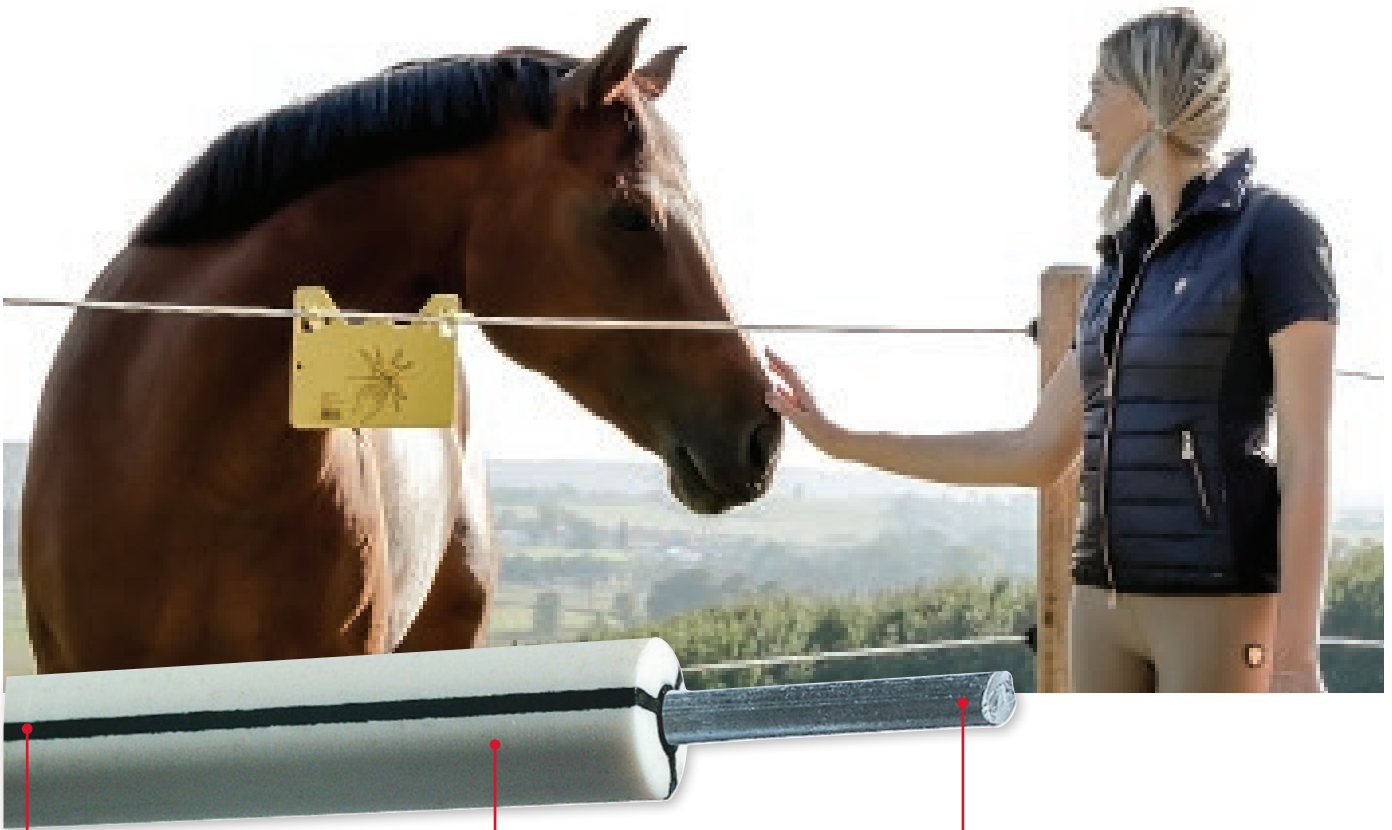

**electrically conductive plastic**  
The iron wire is enclosed by a layer of electrically conductive carbon fibre plastic mix that reaches up to the surface through three lines.

**Polyethylene polymer**  
The area between the conductive material is surrounded by a sheath of white UV-stabilised polyethylene.

**Iron Wire**  
inside there is a galvanised iron wire of 2 mm thickness

## TopLine Horse Wire

Our proven electrifiable horse fencing system is now also available in a reduced diameter version. In the consistent ongoing development of our Premium Horse Wire, we focussed on the ease of applying the fence system while retaining the high quality materials and workmanship.

- low resistance of 0.055 ohms/m, meaning very high conductivity through 2 mm galvanised iron wire
- the reduced diameter of case and wire makes the product softer and more flexible, thus easier to work with
- extremely weather-resistant and durable
- lower physical hazard for horses due to round and smooth surface





5-year warranty

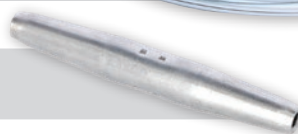

the innovation in fixed fencing – ideal for horse pastures

Tip: Use our 'Wire LINK' (442367) for connection



Ref. no.	Length	Ø	max. recommended fence length	Resistance	Break load	 	€
442390	200 m	6 mm	36 km	0.055 Ω/m	400 kg	1 25	

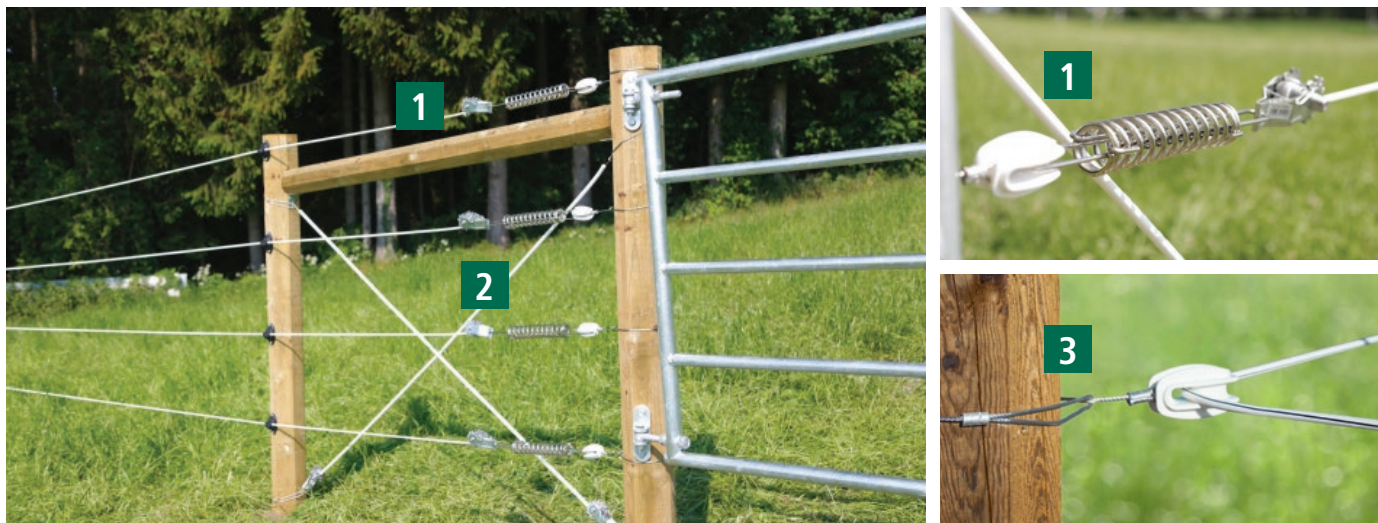

## De-tensioning Set „Horizontal“

- for tensioning posts with a diameter of up to 160 mm

Set includes: 1 x insulation (polyamide), 1 x stainless steel temperature equalisation spring, 1 x permanent wire tensioner (without clamping lever), 1 x stainless steel wire rope loop for fast and easy attachment to the tension post



Ref. no.	can be used for		€
446509	steel wire, Premium Horse Wire, TopLine Horse Wire	1/20	

Ref. no.	Description	Colour	Length	MOQ	Pieces / unit		€
446506	Protective Hose for Temperature Equalisation Spring	black	50 cm	1 pack	3 / pack	1/10	

## De-tensioning Set „Diagonal“

Set for the diagonal de-tensioning of an H post design in the corner and at the fence start and/or end for very high tensile forces of the conductor material.

Set includes: 1 x hose insulator, 1 x stainless steel wire rope loop, 1 x permanent wire tensioner (without clamping lever), 2 x 90° metal brackets and wood screws



Ref. no.	can be used for		€
446508	steel wire, Premium Horse Wire, TopLine Horse Wire	1/10	

## Corner Solution for Fixed Fences

- Polyamide de-tensioning isolator with stainless steel wire loop for fast and easy attachment to the tension post
- for corner posts with a diameter of up to 160 mm

- 1 pack contains: 3 x stainless steel wire loop for fast and easy attachment to the tension post, 3 x de-tensioning insulator (polyamide)





Ref. no.	MOQ	Pieces / unit		€
446507	1 pack	3 / pack	1/20	

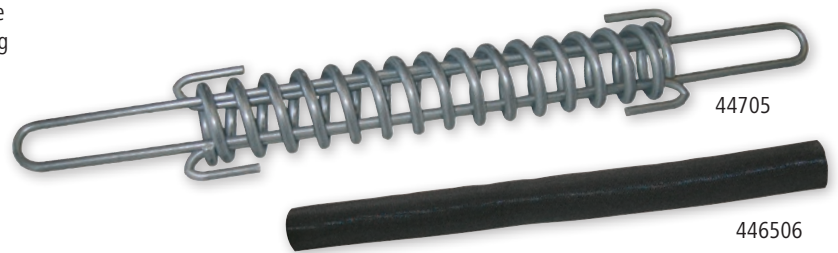

## Temperature Equalisation Spring

- stable design for steel wire
- eases strain on wire and corner posts
- balances temperature variations and renders the fence flexible
- protective tube prevents horse hair being trapped in the spring



Ref. no.	Length	Ø	Material	can be used for		€
44704	43.5 cm	43 mm	galvanised metal	steel wire 2.5 mm	1/20	
44705	43.5 cm	43 mm	stainless steel	steel wire 2.5 mm	1/20	
44259	20 cm	25 mm	stainless steel	steel wire 1.6 mm	1/60	

Ref. no.	Description	Colour	Length	MOQ	Pieces / unit		€
446506	Protective Hose for Temperature Equalisation Spring	black	50 cm	1 pack	3 / pack	1/10	

## Gear-toothed wire tensioner

- tightens/loosens rapidly wires, ropes and poly wires
- with cliplock



Ref. no.	Description	Material		€
44509	single	metal	1/50	
441327	with integrated insulator	metal	1/20	
441297	with integrated insulator and wire rope	metal	1/10	

Ref. no.	Description		€
441328	Clamping Lever for Gear-toothed Wire Tensioner	1/20	



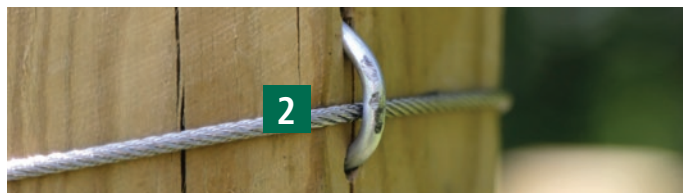

## Fin Tube Insulator

- Polyethylene pipe as insulation corner solution in the permanent fence
- nail on with staples 44394 (not included)
- Suitable for: rope up to Ø 8 mm, Premium Horse Wire, TopLine Horse Wire

Ref. no.	Colour	Length	Ø	MOQ	Pieces / unit		€
44392	white	60 cm	8 mm	1 pouch	10 / pouch	1/10	13,99

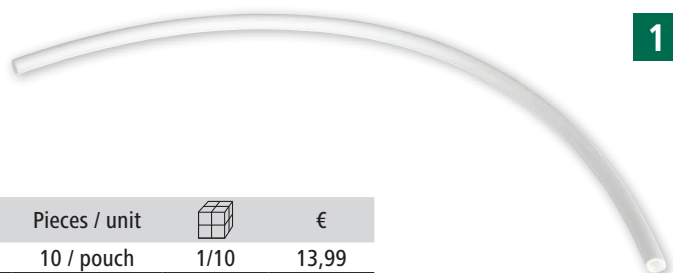

## Staples

- Material: galvanised metal

Ref. no.	Length	Width	MOQ	Pieces / unit		€
44394	47 mm	3.8 mm	1 pouch	50 / pouch	1/20	



## Wire tensioner

- rotatable
- tightens/loosens rapidly wires, ropes and poly wires without cutting them in two

Ref. no.	Material	MOQ	Pieces / unit		€
44513	metal	1 pack	1 / pack	1/32	
44513/031	metal	1 pack	3 / pack	1/50	

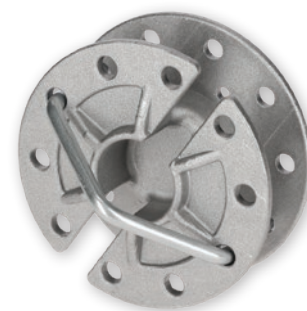

## Tensioning Arm for Wire Tensioner

- Material: galvanised metal

Ref. no.		€
44514	1/20	



## Chain tensioner

- ideally suited for tensioning all kinds of electric fence wire
- two-piece
- Material: metal

Ref. no.		€
441269	1/4	

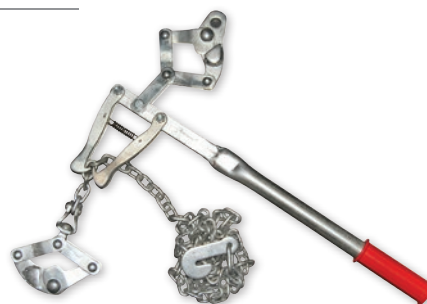

## Farming Forceps Standard

- cuts wire up to Ø 5 mm
- essential for fence construction
- can also be used as a hammer

Ref. no.	Colour		€
28255/1	black	1/6/36	





## Porcelain Corner Insulators

- professional corner insulator made of porcelain
- high-quality
- withstands extreme tensile loads
- for hanging
- Length: 42 mm



Ref. no.	Colour	MOQ	Pieces / unit		€
442362	white	1 box	10 / box	1/10/200	
442362/061	white	1 pack	6 / pack	1	

## Porcelain Corner Insulators

incl. wire rope with eyelet in set of 3

- user-friendly corner solution for all types of fence wire
- professional corner insulator made from porcelain incl. stainless steel wire loop for easy and quick installation on the corner post
- withstands extreme tensile loads
- suitable for corner posts with a diameter of up to 160 mm
- for hanging



Ref. no.	Colour		€
446504	white	1/20	

## Porcelain Strain Insulator

- extremely durable starting and end insulator for fence wires
- withstands extreme tensile loads
- Material: Porcelain
- for hanging
- 10-year guarantee

10-year guarantee



Ref. no.	Colour	MOQ	Pieces / unit		€
442363	white	1 box	10 / box	1/10/200	

## Wire Connectors Wire Link

Sturdy wire connector allows the connection of two wires without tools. The wire is simply pushed into the opening and cannot free itself without intervention.

Expertentipp: keine Verletzungsgefahr durch überstehende Drahtenden - ideal für Pferdeweiden mit Premium Horse Wire bzw. TopLine Horse Wire



Ref. no.	Material	can be used for	MOQ	Pieces / unit		€
442367	Aluminium	steel wire 1.8 - 2.5 mm, Premium Horse Wire, TopLine Horse Wire	1 pouch	2 / pouch	1/200	

## Wire connecting clamp

- for the safe, vertical connection of fixed fence wire series and/or the underground cable with the fence wire

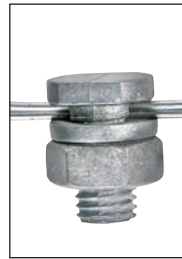

Ref. no.	Material	can be used for	MOQ	Pieces / unit		€
441225	galvanised metal	steel wire up to 2.5 mm, Premium Horse Wire, TopLine Horse Wire	1 pouch	10 / pouch	1/10/500	
441225/041	galvanised metal	steel wire up to 2.5 mm, Premium Horse Wire, TopLine Horse Wire	1 pack	4 / pack	1/50	

## Wire connecting clamp

- suitable for the electrical cross-connection of multiple wires

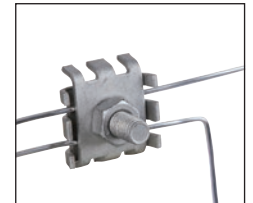
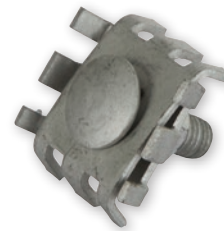

Ref. no.	Material	can be used for	MOQ	Pieces / unit		€
442364	galvanised metal	steel wire up to 2.5 mm	1 pouch	10 / pouch	1/10/500	

## Gripple Wire Connectors

- the Gripple system repairs fences 6 x faster than conventional connectors

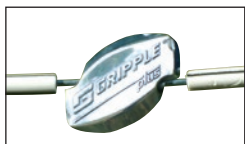

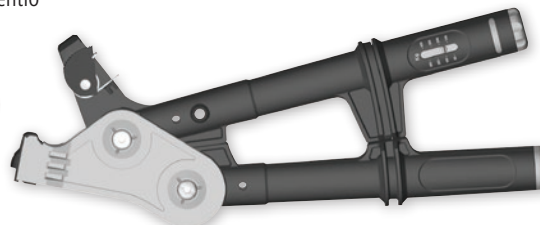

44706-0



**GRIPPLE**



Ref. no.	can be used for	Operating load	MOQ	Pieces / unit		€
44707	steel wire 1.4 - 2.2 mm	220 kg	1 pack	20 / pack	1/20/300	
44706	steel wire 2.0 - 3.25 mm	400 kg	1 pack	20 / pack	1/20/200	
44706/066	steel wire 2.0 - 3.25 mm	400 kg	1 pack	6 / pack	1	
44706-0	steel wire 2.0 - 3.25 mm	400 kg	400 pieces	400 / bucket	1/400	NEW

Ref. no.	Description		€
44703	collet chuck with voltmeter	1/4	



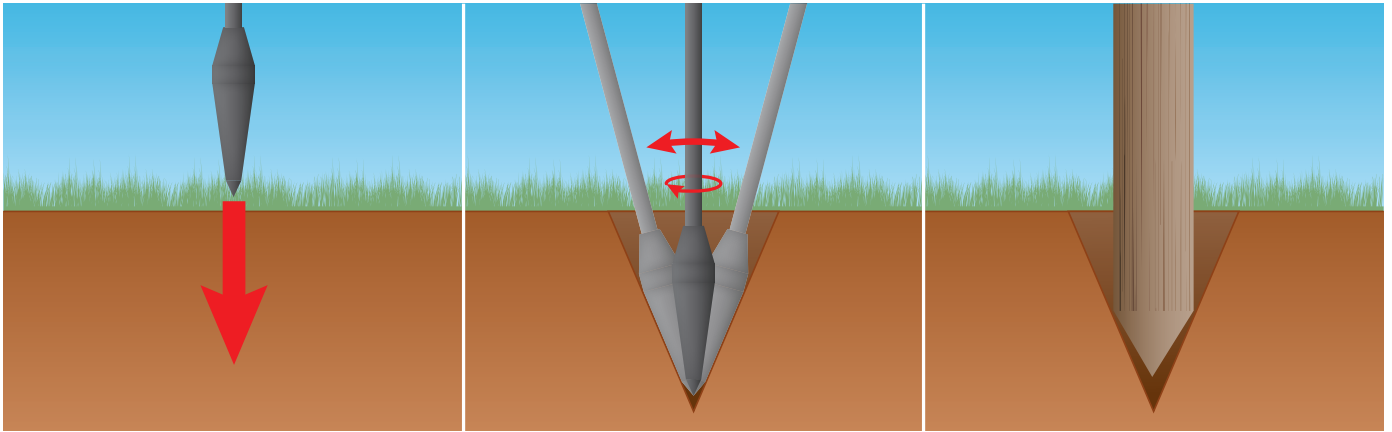

## Stake iron

- for piercing the ground for large fence posts (wooden stakes, etc.)
- made from hardened, round, powder-coated silicone spring steel
- with round tip and rounded steel pommel for the hand

Made in Germany





Ref. no.	Colour	Length	Weight approx.			€
441425	black	130 cm	7 kg	1	100	

## Post Hole Digger

- the ideal aid for fence building
- fatigueless drilling before posts are set up
- with T-handle





Ref. no.	Material	Ø			€
44484	steel, lacquered	70 mm	1	50	
44485	steel, lacquered	90 mm	1	50	
44486	steel, lacquered	150 mm	1	30	

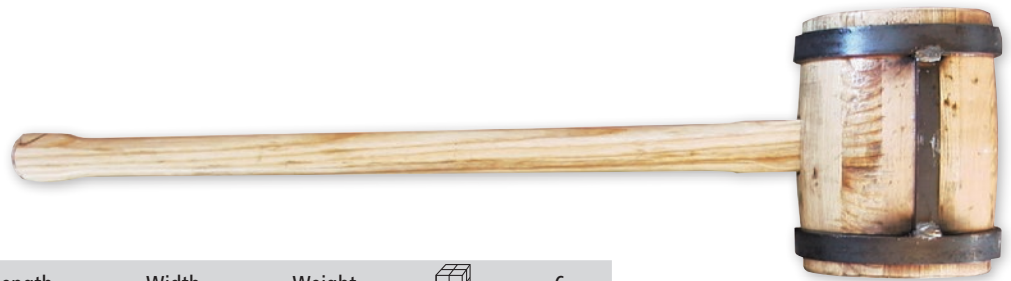

## Wooden Mallet

- incl. welded scorper



Ref. no.	Material	Length	Width	Weight		€
44482	ash	93 cm	23 cm	6 kg	1	

Ref. no.	Description	Material	Length		€
44483	Handle for Wooden Mallet	ash	95 cm	1/10	

## Sledge Hammer

- hammer head made from break-proof plastic
- hickory handle



Ref. no.	Colour	Weight		€
441422	black	5 kg	1	

## Hand Pile Driver

- for hammering in pasture fence posts up to Ø 100 mm

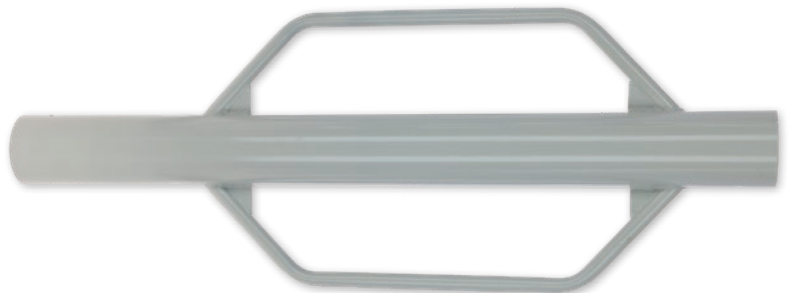

Ref. no.	Material	Diameter	Interior diameter	Weight		€
44471	metal	114 mm	108 mm	12 kg	1	



# Octo Wood



## Raw materials

OctoWood uses only slow-growing Scandinavian pine grown north of 64 degrees latitude:

- Low temperatures
- Not much daylight
- Smaller tree crowns
- Straight trunk
- High rigidity
- High breaking load

With its 8 sides, the wooden post with ingenious octagonal profile of pine wood (*Pinus Sylvestris*) enables flexibility when fitting insulators. The most commonly used fence post is available in different lengths as well as different diameters, allowing it to be used in any fence system. Pine wood is not a hardwood and is therefore easy to work with.



**Even growth rings** = even growth

**Close growth rings** = Slow growth

**Heartwood**

- Does not have to be impregnated
- Contains the natural fungus inhibitor 'pinosylvin'
- Has resin channels throughout
- 'Dead' wood
- Lends the post rigidity

**Sapwood**

- Only the sapwood part is impregnated
- The membrane of the wood fibre cell is coated in a copper sulphate layer
- Impregnated with Wolmanit CX in a pressure tank process

10 cm

The Octo Wood cross bar (441835) is ideal for construction of horse-riding courses



# Wooden Posts for Permanent Fencing

10-year guarantee



## OctoWood

- ingenious octagonal profile made from *Pinus silvestris* = pine wood
- thanks to straight outer surfaces, the insulators can be assembled particularly easily without any pre-drilling
- the octagonal profile ensures a secure grip on pallets and makes transport easier as it does not roll away
- with highly effective pressure impregnation, therefore ideal for use class 4 (= exposed to constant weathering and ground contact)
- the impregnation effectively protects the wood from moisture, prevents rotting and therefore increases stability and durability
- pressure-impregnated wood requires less maintenance than untreated wood and is less susceptible to warping or shrinkage
- the post is perfectly and evenly protected - without any gaps - against insects, fungi and mould rot
- this post is also well-suited for erecting a wooden fence
- suitable for continuous earth and water contact
- 10-year guarantee

Ideal for corner, gate, first and last posts

Ref. no.	Description	Total height	post Ø			€	
441827	Corner / Gate Post	210 cm	140 mm	1	48		
441828	Corner / Gate Post	250 cm	140 mm	1	48		
441820	Track Post	150 cm	60 mm	1	252		
441821	Track Post	200 cm	60 mm	1	252		
441822	Track Post	180 cm	80 mm	1	154		
441823	Track Post	200 cm	80 mm	1	154		
441824	Track Post	225 cm	80 mm	1	154		
441825	Track Post	200 cm	100 mm	1	99		
441826	Track Post	225 cm	100 mm	1	99		

Ref. no.	Description	Length		€	
441835	Cross Bar Octo Wood	350 cm	1		

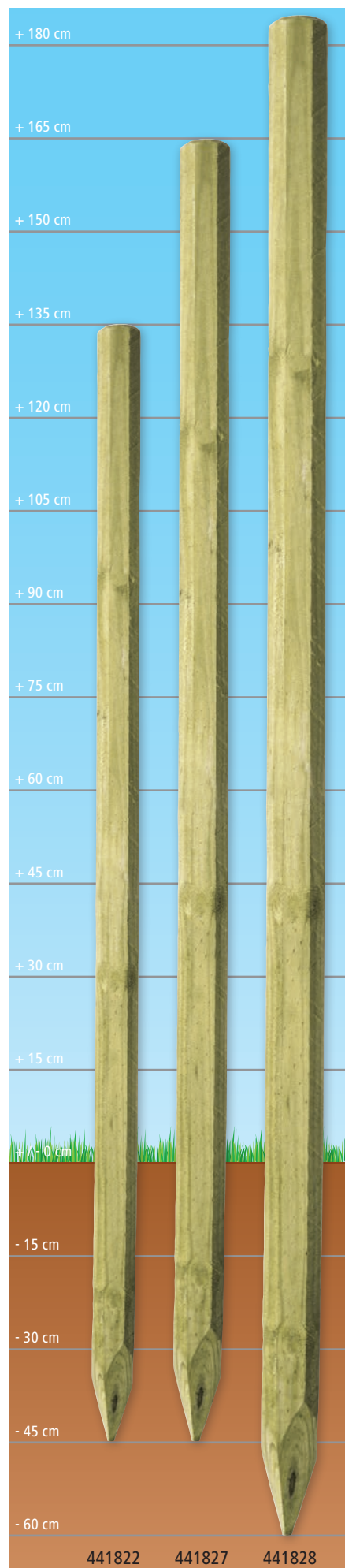

# Recycled Posts

---



Sustainable recycling and the circular economy are omnipresent nowadays and more important than ever in light of dwindling resources. Our recycled posts are therefore made entirely from post-consumer material: the old plastic in the yellow bag is used to create high-quality and robust material which is used as a resource-sparing raw material for our posts. Since production processes must also be taken into account in a meaningfully sustainable circular economy, the entire recycling, reprocessing and production process takes place in Germany. Made in Germany stands not only for top quality but also for short and sustainable paths in the manufacturing process for this environmentally conscious product line.

Made in Germany 







10-year guarantee 



- Outstandingly suitable for soft, moist, or deep soils
- Extremely durable
- Optimum handling options (screwing, nailing, sawing, drilling)
- Fully insulated
- Ground water-neutral and rot-proof
- Sharpened at one end
- Ideal as a track post

## Recycling Post Round Profile



- drive into the ground about 50 – 60 cm deep
- tried-and-tested round profile
- 10-year guarantee

Ref. no.	Total height	post Ø			€
44460	130 cm	45 mm	1	165	
44462	150 cm	50 mm	1	300	
44463	150 cm	60 mm	1	125	
44474	185 cm	60 mm	1	125	
442071	200 cm	70 mm	1	74	
44465	180 cm	75 mm	1	60	
44467	200 cm	75 mm	1	60	
44469	220 cm	100 mm	1	33	

## Recycled Post Cross Profile

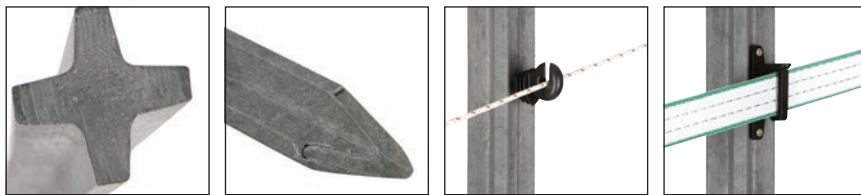
- very sturdy cross profile
- 10-year guarantee







Ref. no.	Total height	post Ø			€
442059	150 cm	70 x 70 mm	1	120	
442043	200 cm	70 x 70 mm	1	120	

## Recycling Post Square Profile

- practical square profile
- 10-year guarantee



Ref. no.	Total height	post Ø			€
442057	175 cm	70 x 70 mm	1	55	
44478	175 cm	90 x 90 mm	1	45	
44477	200 cm	90 x 90 mm	1	45	

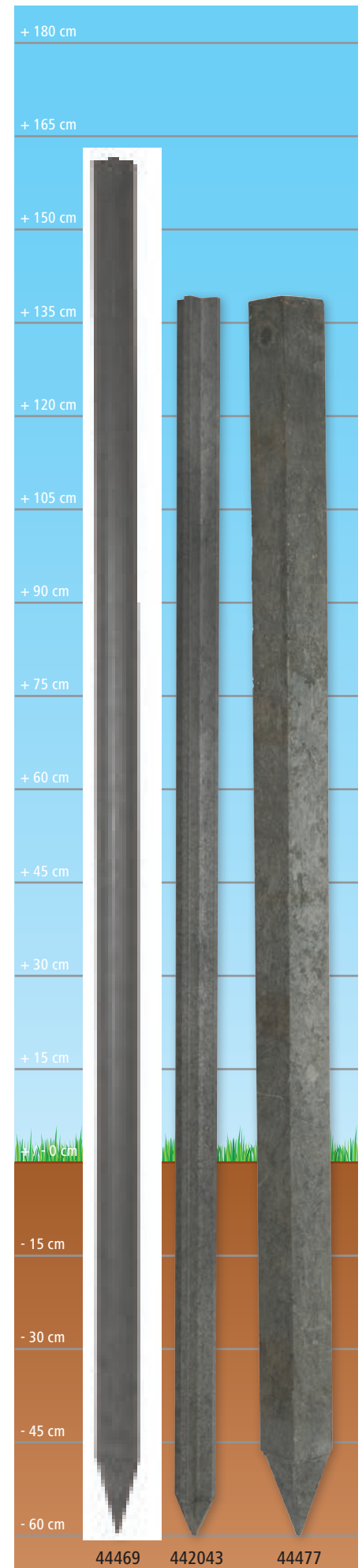







## T-Post and Accessories

### Raw materials

Our T-Post is made from prepared, hot-rolled rail steel, which is one of the strongest and most durable types of steel. Due to its extreme rigidity, this steel will only become minimally deformed even under the highest stress and is therefore the best choice for the construction of semi-permanent fence systems and fixed fences. The typical green paint also protects the stable rail steel of the T-Posts from the influences of weather. The entire post is covered in nubs spaced at intervals of 55 mm to enable the set-up of fences of various heights. This enables the easy attachment of a wide range of insulators for all conductor materials, tool-free and at any height.

T-post profile



### Assembly

The T-post can be installed by just one person with the help of a specially developed pile driver (446540). Here, please bear in mind that the posts must be driven sufficient deep to ensure that the entire 18 cm-long anchor plate (drive-in depth approx. 40 cm) is sunk into the ground.

High-quality, easy-installation T-posts in various lengths for long-term use. The entire post is covered in nubs spaced at intervals of 5.5 cm for attaching accessories. A robust base plate gives the post a secure footing. The paint on the posts guarantees high weather resistance. We recommend using T-posts that are approx. 30 cm longer for each corner. The insulators can be fixed securely at the desired height by clipping them to the T-post.

T-posts are suitable for all types of pasture, as a supplemental fence for rotational grazing, as a semi-permanent paddock fence, and as a way to fence in an outlet.

### Fixed fence guide

Browse the new AKO fixed fence guide online or request your free copy by e-mail at [info@kerbl.com](mailto:info@kerbl.com)!



# T-Post and Accessories

## Metal Post T-Post

- with solid base plate
- drive into the ground about 40 cm
- perfect for horses, cattle and wild animal fences

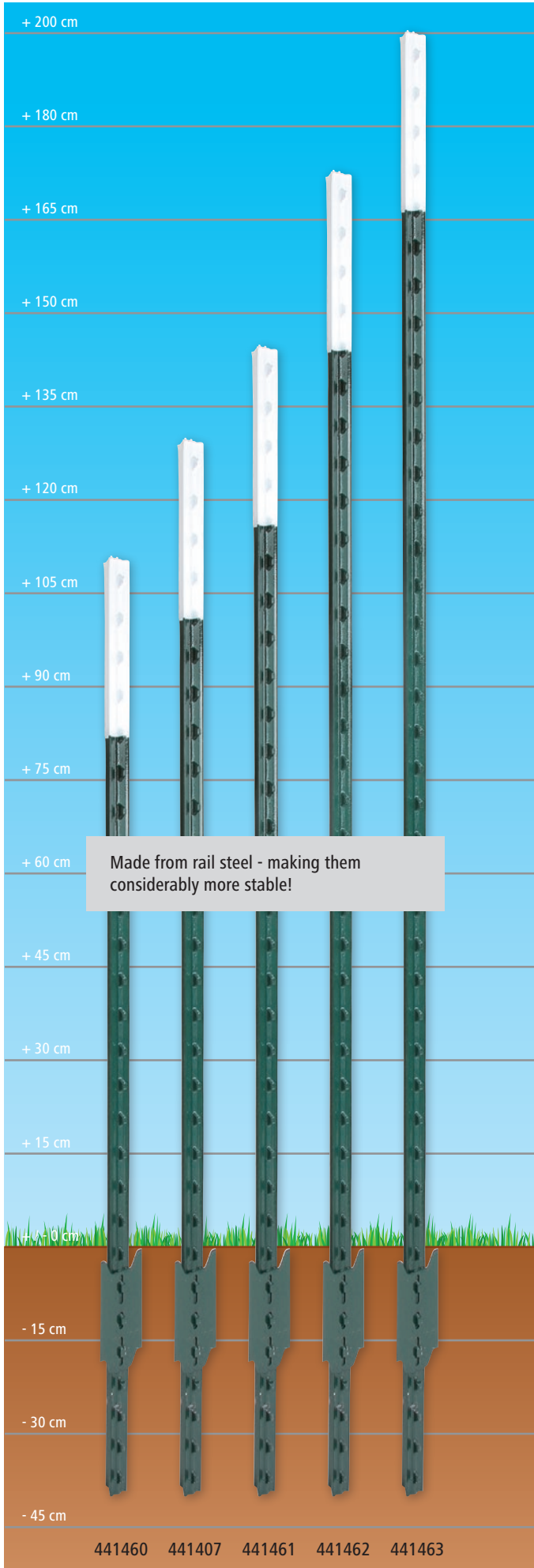

Ref. no.	Colour	Total height			€
441460	green / white	152 cm	1/5	200	
441407	green / white	167 cm	1/5	200	
441461	green / white	182 cm	1/5	200	
441462	green / white	213 cm	1/5	200	
441463	green / white	240 cm	1/5	200	





## Fence Starter Set T-Post

The support kit...Installation of a fence starter with T-posts

- Drive the gate or junction post approx. 40 - 50 cm into the ground...
- Drive in the next track post using a spacing of 1.50 m...
- Remove the base plates from the diagonal support post...
- Install the fence starter set on the gate or junction post and on the track post...
- Attach the diagonal support post to the sleeve and align it.

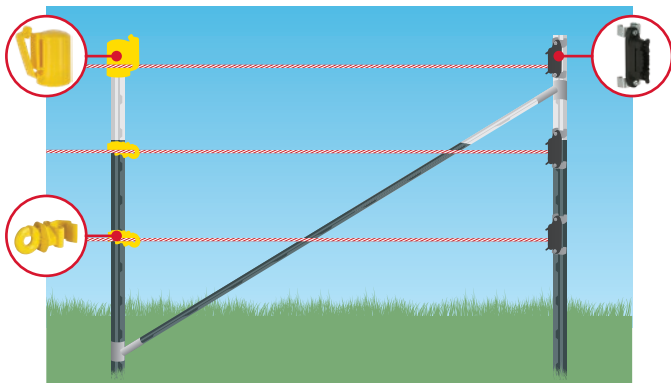

Set includes: 2 x brackets for diagonal strut, incl. fastening screws and protective caps

Ref. no.		€
441178	1/12	

## Variable Corner Solution Set T-Post

The corner in detail...Installation of a corner with T-posts

- Drive the corner post approx. 40 - 50 cm into the ground...
- Drive in both additional corner and stretch posts using a spacing of 1.50 m each...
- Remove the base plates from both diagonal support posts...
- Install the corner solution set on the corner posts...
- Attach the diagonal support posts to the sleeve and align them.

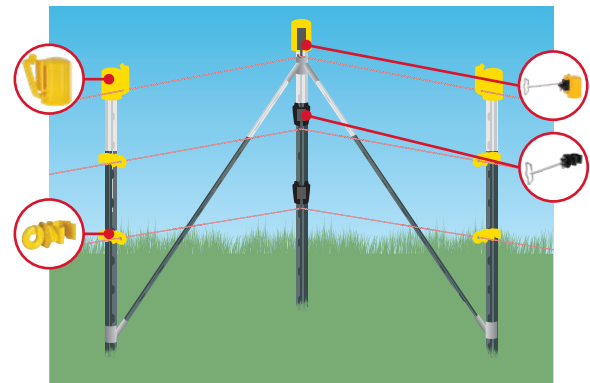

We recommend using our T-Post corner insulators on the corner post to avoid the conductor touching the diagonal support posts.

Set includes: 1 x corner bracket universal, 4 x two brackets for diagonal brace incl. fixing screws and caps, incl. fitting instructions

Ref. no.		€
441177	1/6	

## Head Insulator T-Post

- new design with improved post support
- can be extended with corner solutions for tapes and ropes
- avoids injuries to animals at the post end
- Material: plastic, UV-stabilised
- clip-on
- Suitable for: Wire, Poly wire, Rope, tape up to 40 mm



We generally recommend using a head insulator

Ref. no.	Colour	MOQ	Pieces / unit		€
441252	black	1 pouch	10 / pouch	1/10/200	
441253	yellow	1 pouch	10 / pouch	1/10/200	



The ideal solution for preventing the conductor material touching the diagonal support posts in the corner structure.

## Head Insulator Tape/Rope Corner Solution T-Post

- the highest quality with a stainless steel frame
- conductor material is protected by rounded edges
- Suitable for: Poly wire, Rope, tape up to 40 mm

NEW: stainless steel brackets now universally applicable for wire, rope and tape up to 40 mm

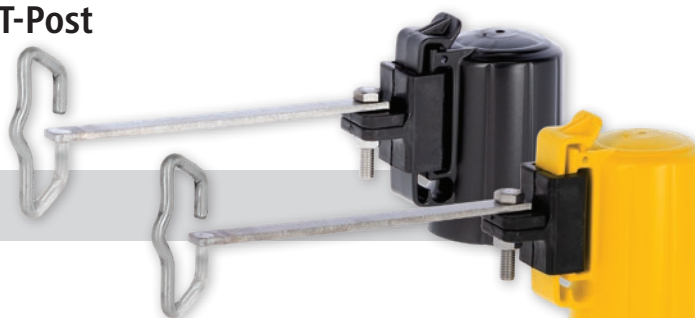

Included in delivery: 4 x head insulators, 4 x spacers, 4 x clips

Ref. no.	Colour	Support length	MOQ	Pieces / unit		€
446536	yellow	15 cm	1 pouch	4 / pouch	1/25	
446537	black	15 cm	1 pouch	4 / pouch	1/25	

## Tape Insulator T-Post

- improved clip system - simplifies fastening to the T-post
- Material: Plastic
- Suitable for: tape up to 50 mm, Rope



Ref. no.	Colour	MOQ	Pieces / unit		€
441183	black	1 pouch	25 / pouch	1/25/200	
441184	yellow	1 pouch	25 / pouch	1/25/200	

## Pinlock Insulator T-Post

- improved clip system - simplifies fastening to the T-post
- Material: Plastic
- Suitable for: Rope, Poly wire, Wire, tape up to 10 mm



Ref. no.	Colour	MOQ	Pieces / unit		€
441186	black	1 pouch	25 / pouch	1/25/200	
441187	yellow	1 pouch	25 / pouch	1/25/200	

## Ring Insulator T-Post

- improved clip system - simplifies fastening to the T-post
- Material: Plastic
- Suitable for: Wire, Poly wire, Rope, tape up to 10 mm

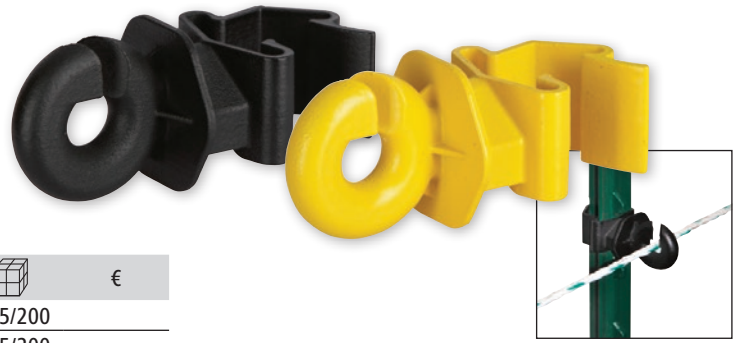

Ref. no.	Colour	MOQ	Pieces / unit		€
441180	black	1 pouch	25 / pouch	1/25/200	
441181	yellow	1 pouch	25 / pouch	1/25/200	

## Rope Insulator T-Post

- extra robust design
- improved clip system - simplifies fastening to the T-post
- Material: Plastic
- Suitable for: Wire, Poly wire, rope up to Ø 8 mm, tape up to 10 mm



Ref. no.	Colour	MOQ	Pieces / unit		€
441189	black	1 pouch	25 / pouch	1/25/200	
441190	yellow	1 pouch	25 / pouch	1/25/200	

## Distance Insulator T-Post

- distance between wires 12.5 cm
- simplifies fastening to the T-post
- Material: Plastic
- Suitable for: Wire, Poly wire, Rope, tape up to 10 mm

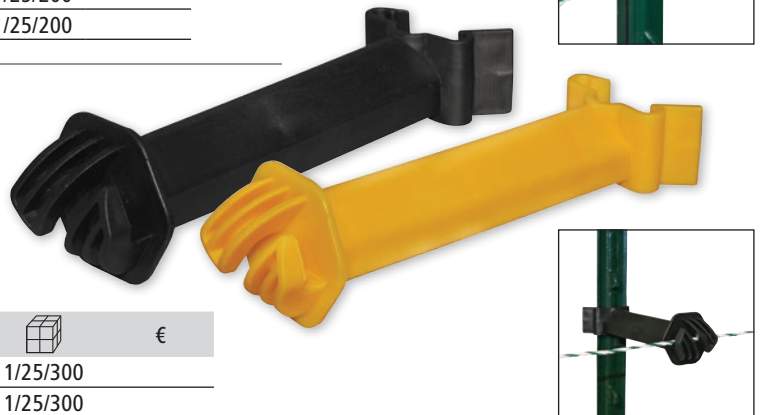

Ref. no.	Colour	MOQ	Pieces / unit		€
442343	black	1 pouch	25 / pouch	1/25/300	
442344	yellow	1 pouch	25 / pouch	1/25/300	

## Rear side spacer insulator T-Post

- easy to attach to the back of the T-Post using the clip system
- enables a second fence line to be drawn on the opposite side to the normal „front“ side
- drawing a second fence line can secure existing fences against intruders such as wolves
- also ideal for separating paddock compartments, as a row of fencing can be erected on both sides of the posts between the compartments
- Material: Plastic
- Suitable for: Poly wire, Rope, tape up to 20 mm

New product

NEW

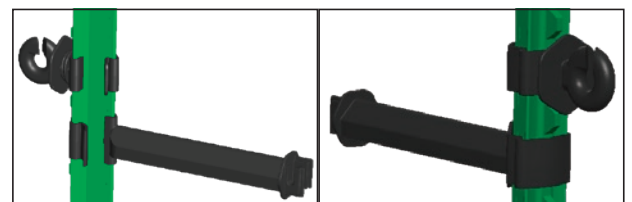

442347: this insulator allows wolf-deterrent fence construction with T-posts for horses in accordance with the current VDE standard on herd protection measures

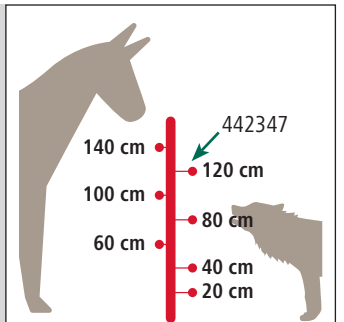

Ref. no.	Colour	Length	MOQ	Pieces / unit		€
442347	black	15 cm	1 pack	25 / pack	1/25	
442348	black	7 cm	1 pack	25 / pack	1/25	

available from: March 2025



## Tape/Rope Corner Solution T-Post

the ideal solution for T-Post corners for fencing ropes and tapes

- the highest quality with a stainless steel frame
- conductor material is protected by rounded edges
- Suitable for: Poly wire, Rope, tape up to 40 mm

NEW: stainless steel brackets now universally applicable for wire, rope and tape up to 40 mm

Included in delivery: 4 x insulators, 4 x spacers

Ref. no.	Support length	MOQ	Pieces / unit		€
446538	15 cm	1 pack	4 / pack	1	

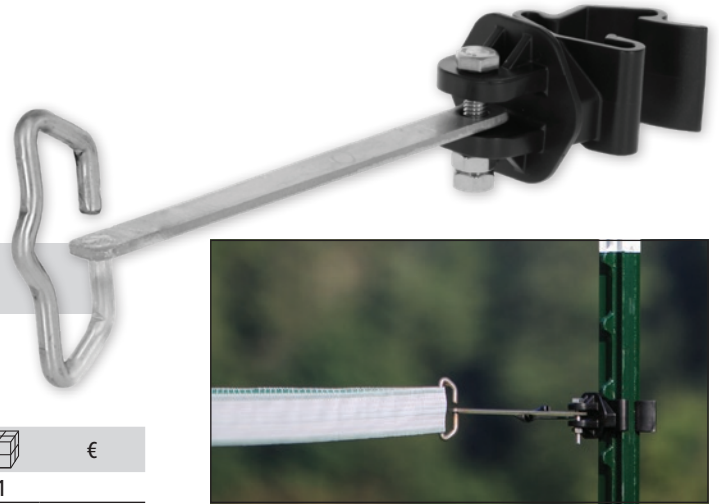

## Gate Insulator T-Post Vario

also ideal for use as a starting insulator  
Stainless steel connecting plate

Set consisting of: 3 x gate insulators, 3 x stainless steel connecting plates each with 3 connection options

Ref. no.	Colour	MOQ	Pieces / unit		€
446516	black	1 pack	3 / pack	1	



## Gate Insulator T-Post

- clip-on with universal clamps

Set consisting of: 4 x gate insulators, 4 x universal clamps

Ref. no.	Colour	MOQ	Pieces / unit		€
441231	black	1 pack	4 / pack	1/50	



## Tape Gate Insulator Set T-Post Premium

- a robust tape insulator with stainless steel connecting plate for gate handle and pasture fence connection
- clip-on with universal clamps
- Suitable for: Rope, tape up to 40 mm

also ideal for use as a starting insulator  
Stainless steel connecting plate

Set consisting of: 2 x insulators with stainless steel plate, 4 x T-post universal clamp

Ref. no.	Colour	MOQ	Pieces / unit		€
441494	black	1 pair	2 / pack	1	



## Tape, Rope and Corner Insulator T-Post

- clip-on with universal clamps
- Suitable for: Poly wire, Rope, tape up to 40 mm

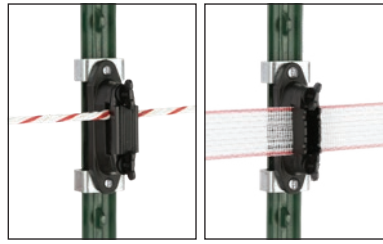

Set consisting of: 4 x prof corner/stretch Insulator, 8 x universal clamps

Ref. no.	Colour	MOQ	Pieces / unit			€
441232	black	1 pack	4 / pack	1	120	

## Rope Corner Insulator T-Post

- clip-on with universal clamps
- Suitable for: Poly wire, Rope, tape up to 10 mm



Set consisting of: 4 x rope insulator, 4 x universal clamps

Ref. no.	Colour	MOQ	Pieces / unit		€
441233	black	1 pack	4 / pack	1/100	

## Corner insulator Premium

- extra strong finish made from polyamide plastic (PA)
- no slipping of the conductive material on the metal support thanks to the insulator's special shape
- Material: Polyamide
- with metric thread
- with continuous galvanised support Ø 8 mm
- Suitable for: Rope, Poly wire, Wire
- 2 nuts included

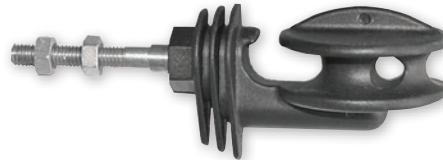

Universal clamps (44790) not included.

Ref. no.	Colour	Thread	Thread length	MOQ	Pieces / unit		€
441360	black	M6	30 mm	1 pouch	10 / pouch	1/10/250	

## Tape Corner Insulator Cavallo

- extra strong finish made from polyamide plastic (PA)
- free-running tape is fed through safely thanks to smooth, rounded surface
- with metric thread
- with continuous galvanised support Ø 8 mm
- Suitable for: tape up to 40 mm
- 2 nuts included



Universal clamps (44790) not included.

Ref. no.	Colour	Thread	Thread length	MOQ	Pieces / unit		€
441377	black	M6	30 mm	1 pouch	10 / pouch	1/10/250	

## Universal Clip Set T-Post

the ideal solution for attaching insulators to the fence start, corner, and gate systems in T-Post systems

Made in Germany



- simple and quick fixation of wooden screw-in insulators to the T-Post
- insulators are attached to the universal clip by means of screws
- universal clip can be attached or retrofitted to the T-Post quickly at any time, without using a tool, using proven clip system

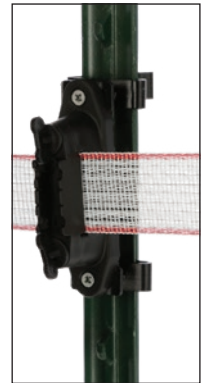

Set consisting of: 8 x universal clip, 8 x screw

Ref. no.	MOQ	Pieces / unit		€
441176	1 pack	8 / pack	1/50	

## Universal Clamp Set T-Post

- usage on the T-Post enables universal fitting of all insulators with M6 metric thread or with 6 mm diameter hole
- Material: metal

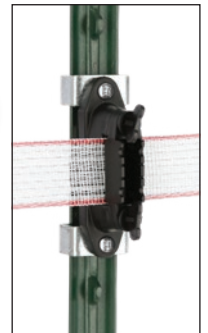

Set consisting of: 2 x universal clamps, 2 x mounting screws

Ref. no.	MOQ	Pieces / unit		€
44790	1 pouch	2 / pouch	1/2/200	



## Fixing Clips for T-posts

- for attaching wire, wild animal fence or knotted mesh to the T-post (cannot be used for electrified wires)
- can be used for all commercially available T-posts
- robust design
- quick and easy installation by placing the clip on the post and then bending the ends over using pliers or a screwdriver
- ideal also for garden and wire mesh fences
- Material: galvanised metal



Ref. no.	MOQ	Pieces / unit		€
441175	1 pack	25 / pack	1/50	





## Ram for T-Post

- makes it easy to drive the t-post into the ground
- extra robust design

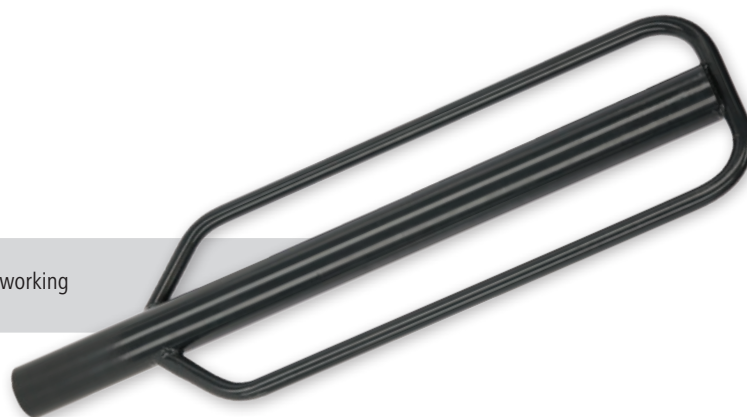

- NEW: continuous tubular grip for even more comfortable and safe working

Ref. no.	Colour	Material	Length	Interior diameter	Weight		€
446540	anthracite	metal, varnished	80 cm	5.2 cm	8 kg	1	

## Puller for T-Post

- enables the easy dismantling of your T-post



Ref. no.	Colour	Material		€
441300	red	metal, varnished	1	

## Angular Steel Post

The angled steel posts are suitable for all-year-round use. There is no danger of breaking, even at the lowest temperatures.

- excellent for dry and rocky areas • powder-coated • with double step

444215: with holes at 20, 40, 60, 90, 120 cm – ideal for 5-row wolf defence fences



Top Seller

Ref. no.	Colour	Total height	Material thickness	Length ground nail	Holes	MOQ	Pieces / unit			€
44421	red	115 cm	2 mm	18 cm	4	1 pack	10 / pack	1/10	500	
444213	red	115 cm	3 mm	18 cm	4	1 pack	10 / pack	1/10	500	
444215	red	150 cm	3 mm	20 cm	5	1 pack	10 / pack	1/10	500	
44453	red	165 cm	3 mm	20 cm	5	1 pack	10 / pack	1/10	500	

## Splint Insulator for Angled Steel Post

- new improved version – now even more robust • Material: Polypropylene • Suitable for: Poly wire, Rope, tape up to 10 mm • incl. metal pin



Ref. no.	MOQ	Pieces / unit			€
446530	1 pouch	25 / pouch	1/25/500	18,000	
446530/1257	1 bucket	125 / bucket	1	96	

## Spring Steel Post Profi

- oval fence post made from high-quality, extra-strong spring steel • highly visible, yellow head insulator is firmly fixed to the post and suitable for wires/ropes up to 6 mm in diameter • strong, welded tread plate enables quick and easy installation • ideal for fencing in dairy cows and cattle • extremely robust and resilient • with tread plate

New product

NEW



Ref. no.	Description	Colour	Total height	post Ø	Length ground nail	Material ground nail	MOQ	Pieces / unit			€
441403	oval	silver	108 cm	11 x 7 mm	20 cm	metal	3 pack	30 / box	1/10/30	720	

Ref. no.	Description	Colour	Material	MOQ	Pieces / unit		€
4413151	Spare Insulator for Oval Steel Post	black	Plastic	1 pouch	25 / pouch	1/25/400	
4413170/25	Spare Insulator for Oval Steel Post	yellow	Plastic	1 pack	25 / pack	1/20	

## Spring Steel Post

- with large top insulator • with tread plate

Posts for the cattle husbandry, proven for decades

Ref. no.	Description	Colour	Total height	post Ø	Length ground nail	Material ground nail	MOQ	Pieces / unit			€
441458	round	brown	107 cm	8 mm	20 cm	metal	3 pack	10 / pack	1/10/30	720	
441457	oval	brown	107 cm	11 x 5 mm	20 cm	metal	3 pack	10 / pack	1/10/30	720	
441455	oval	brown	106 cm	11 x 5 mm	20 cm	metal	3 pack	10 / pack	1/10/30	720	
441456	oval	brown	106 cm	11 x 5 mm	20 cm	metal	3 pack	10 / pack	1/10/30	720	

Ref. no.	Description	Colour	Material	MOQ	Pieces / unit		€
441316	Additional Insulator Clip for Round Steel Post	black	Plastic	1 pouch	25 / pouch	1/25/400	
441318	Spare Insulator for Round Steel Post	black	Plastic	1 pouch	25 / pouch	1/25/500	
441315/251	Spare Insulator for Oval Steel Post	black	Plastic	1 pack	25 / pack	1/12	
4413151	Spare Insulator for Oval Steel Post	black	Plastic	1 pouch	25 / pouch	1/25/400	
441317/201	Spare Insulator for Oval Steel Post	black	Plastic	1 pack	20 / pack	1/12	
4413171	Spare Insulator for Oval Steel Post	black	Plastic	1 pouch	25 / pouch	1/25/500	
441421	Charge Insulator for Oval Steel Post	red	Plastic	1 pouch	50 / pouch	1/50/1800	
44432	Spare Insulator with Metal Eyelet for Oval Steel Post	black	Plastic	1 pouch	25 / pouch	1/25/500	
44433	Spare Ring Insulator for Oval Steel Post	black	Plastic	1 pouch	25 / pouch	1/25/500	





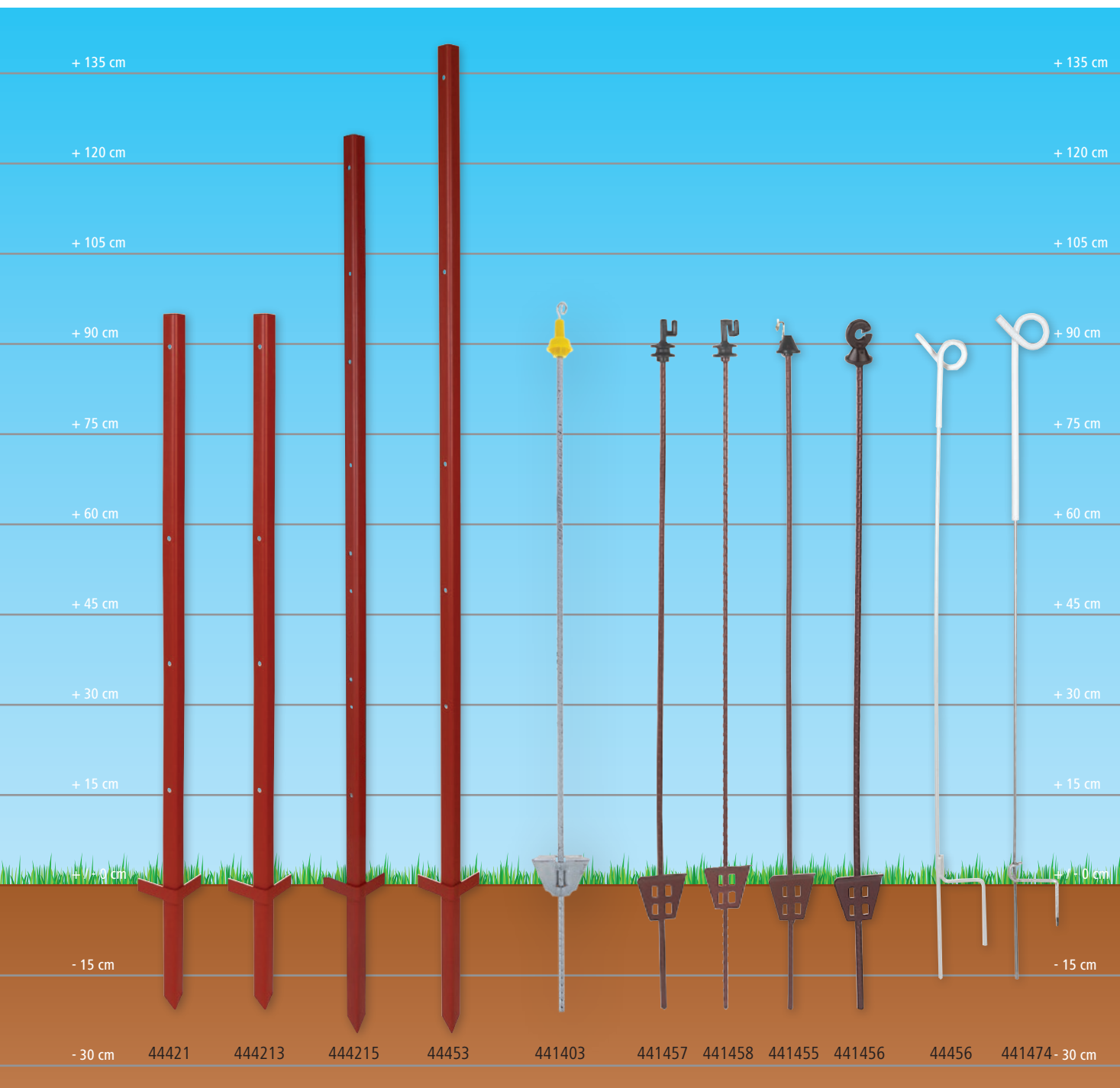

## Eyelet Metal Post

- white post with eye
- Single step with double prong





Ref. no.	Colour	Total height	post Ø	Length ground nail	Material ground nail	MOQ	Pieces / unit			€
44456	white	105 cm	7 mm	15 cm	metal	1 pack	10 / pack	1/10	1,000	

## Spring steel post with eyelets

- galvanised post with eye (PE insulation)
- Single step with double prong



Ref. no.	Colour	Total height	post Ø	Length ground nail	Material ground nail	MOQ	Pieces / unit			€
441474	white	109 cm	6.5 mm	17 cm	metal	1 pack	10 / pack	1/10	1,000	





## Multi Post

- the ideal solution for corner and gate systems for mobile fencing (plastic, metal)
- holder for clasps (44298) not included in the scope of delivery

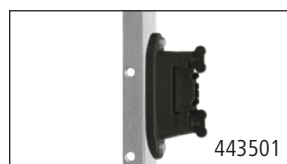
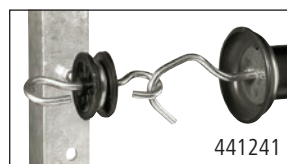
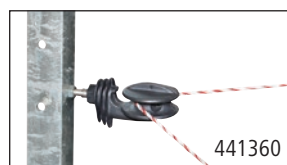
A perfect professional reel system for temporary fencing systems that have to be assembled and disassembled quickly and for many years of use. The indispensable aid for modern fencing.



Ref. no.	Description	Total height	Material thickness			€
44297	for max. 3 reels	120 cm	4 mm	1	150	
44299	for max. 4 reels	165 cm	4 mm	1	150	

Ref. no.	Description	Colour	Material	MOQ	Pieces / unit		€
44324	Ring Insulator for metal post	black	Plastic	1 pouch	25 / pouch	1/25/500	
441360	Corner insulator Premium	black	Polyamide	1 pouch	10 / pouch	1/10/250	
441241	Gate / start insulator	black	Plastic	1 pouch	10 / pouch	1/10/250	
44298	Reel Holder		galvanised metal			1/50	
44355/041	Gate / start insulator for tapes Premium	black	Plastic	1 pack	4 / pack	1/22	
443501	Corner/Stretch Insulator Premium	black	Plastic	1 pouch	10 / pouch	1/10/200	

## Reel Holder

- attaches reel
- with a plastic clamping screw
- Material: galvanised metal
- for hanging reels 44274 and 44296

Ref. no.		€
44298	1/50	

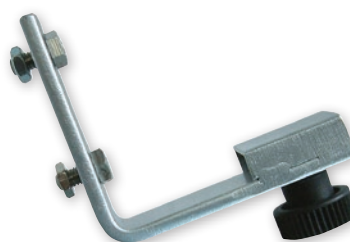



**NEW:** special polyester fleece coating gives the pile a visible honeycomb structure on the surface.

**Advantages:**

- absolutely smooth surfaces and therefore no unpleasant fibreglass residues on the skin
- significantly increased UV-- resistance compared with standard fibreglass posts

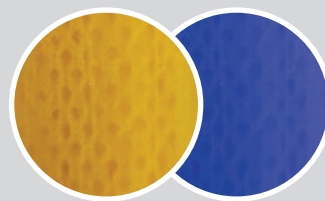

## Oval Fibreglass Post Premium BLUE

- incl. head insulator with plastic eyelet (suitable for wire, stranded wire, rope and tape up to 20 mm)
- very easy to insert and remove the conductor material by turning
- height-adjustable spare insulator available separately (444289)
- with single step



5 year UV stability warranty



with polyester fleece coating

444291, 444292 and 444299: additional reinforcement thanks to sturdy metal sleeve at the transition from the post to the ground nail



Ref. no.	Colour	Total height	post Ø	Length ground nail	Material ground nail	MOQ	Pieces / unit			€
444299	blue	110 cm	10 x 8 mm	18 cm	metal	1 pack	10 / pack	1/10	800	

## Spare Insulator/Additional Insulator

for Oval Fibreglass Post Premium BLUE

- variable height of pole insulator
- absolutely secure attachment
- ideal for retrofitting oval fibreglass post 444299

Ref. no.	MOQ	Pieces / unit		€
444289	1 pack	25 / pack	1/25/1000	





# Fibreglass Posts and Accessories



Plastics that are reinforced with glass fibres have a number of significant advantages when compared to other materials such as steel, iron or simple plastic. The combination of plastic and glass fibres demonstrates significantly better properties when it comes to stability and resistance than conventional plastic. Moreover, our fibreglass posts are very lightweight and cannot rust or rot, making them ideal for outdoor use.

444291, 444292 and 444299: additional reinforcement thanks to sturdy metal sleeve at the transition from the post to the ground nail

## Spare spring

for round fibreglass post

- variable adjustment of pole eyelet • Material: stainless steel • clip-on • Suitable for: Wire, Poly wire, Rope





Ref. no.	Description	MOQ	Pieces / unit		€
444265/30	for fibreglass rods of diameter 10 mm	1 pouch	30 / pouch	1/30/1500	

## Plastic Eyelets

for round fibreglass post

- variable adjustment of pole eyelet • clip-on • Suitable for: Wire, Poly wire, Rope, tape up to 10 mm



Ref. no.	Description	Colour	MOQ	Pieces / unit			€
444011	for fibreglass rods of diameter 10 mm	white	1 pouch	50 / pouch	1/50/1000	18,000	
444012	for fibreglass rods of diameter 12 mm	white	1 pouch	50 / pouch	1/50/1000	25,000	

## Spare Insulator for Oval Steel Post

- variable height of pole insulator • absolutely secure attachment • Material: Plastic
- clip-on • Suitable for: Poly wire, Rope, tape up to 10 mm

- suitable for oval fibreglass post 444291, 444292, 444293

Ref. no.	Colour	MOQ	Pieces / unit		€
444263	black	1 pack	25 / pack	1/25/1000	





# Fibreglass Posts and Accessories

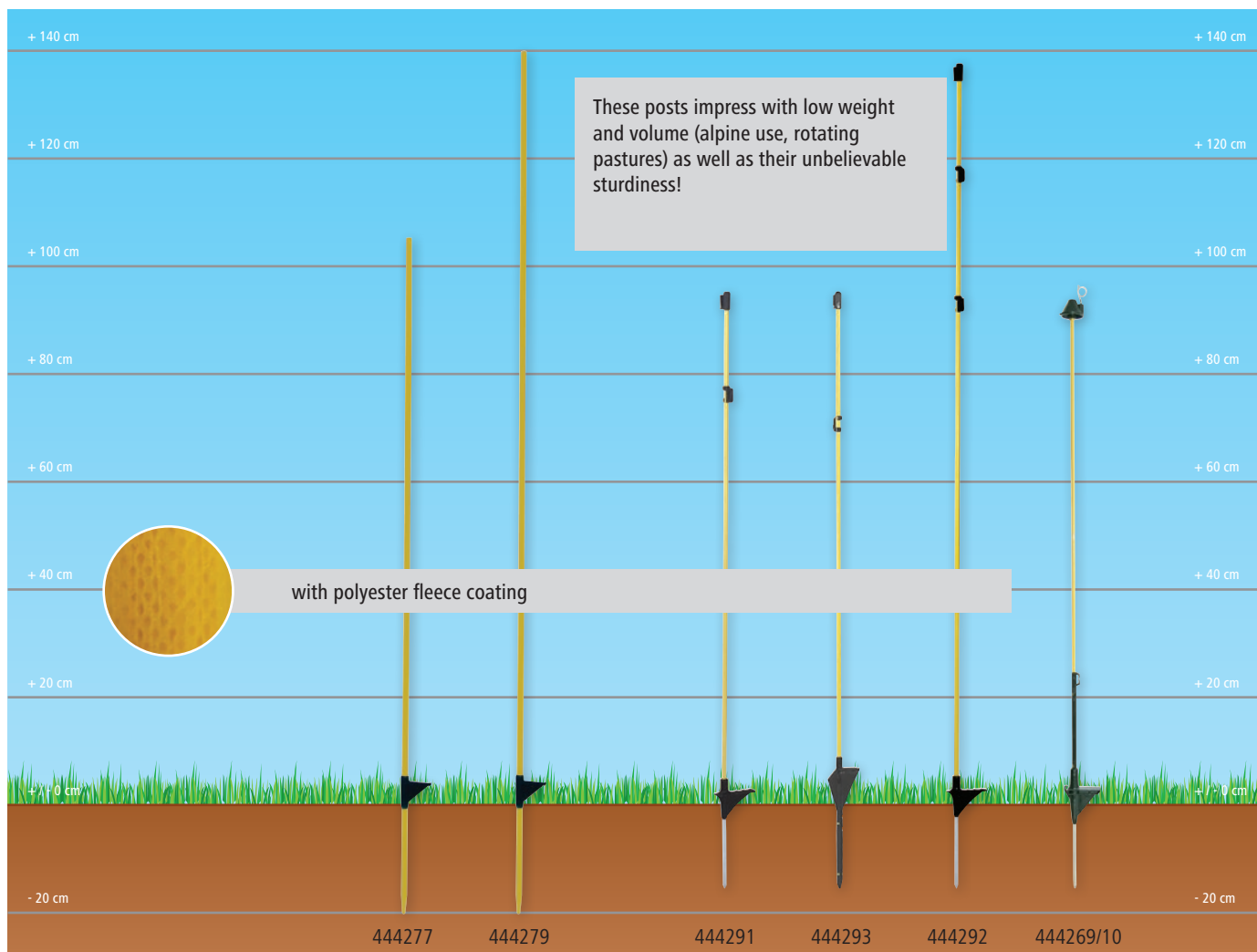

## Round Fibreglass Post

- low weight
- extra robust design
- ideal for cattle, horse and sheep pens
- Insulators not included.
- with polyester fleece coating

5 year UV stability warranty



Ref. no.	Description	Colour	Total height	post Ø	Length ground nail	Material ground nail	MOQ	Pieces / unit			€
444277	with single step	yellow	125 cm	12 mm	20 cm	fibreglass	1 pack	10 / pack	1/10		1,400
444279	with single step	yellow	160 cm	12 mm	20 cm	fibreglass	1 pack	10 / pack	1/10		1,400

## Oval Fibreglass Post

- ideal for cattle, horse and sheep pens
- ideal for poly wires, wires and tapes up to 20 mm
- with single step

5 year UV stability warranty



444269/10: incl. head insulator with metal ring, without polyester fleece coating

444291: incl. head insulator and height-adjustable additional insulator

- with polyester fleece coating

444293: incl. head insulator and height-adjustable additional insulator

- with polyester fleece coating

444292: incl. head insulator and 2 x height-adjustable additional insulators

- with polyester fleece coating

Ref. no.	Colour	Total height	post Ø	Length ground nail	Material ground nail	MOQ	Pieces / unit			€
444269/10	yellow / black	106 cm	10 x 6 mm	18 cm	metal	1 pack	10 / pack	1/10		1,000
444291	yellow / black	110 cm	10 x 8 mm	18 cm	metal	1 pack	10 / pack	1/10		1,000
444293	yellow / black	110 cm	10 x 8 mm	22 cm	fibreglass	1 pack	10 / pack	1/10		1,400
444292	yellow / black	152 cm	10 x 8 mm	18 cm	metal	1 pack	10 / pack	1/10		1,000



## Plastic Post with Stirrup Step

- the post is very easily driven into the ground because the stirrup is positioned directly above the spike
- with fibreglass reinforcement - extremely robust and durable
- for all conventional tapes, poly wires, ropes and wires
- with galvanised ground nail
- with stirrup tread

44417: incl. head insulator for stranded wire, wire and 10 mm tape - also for twisting the stranded wire

444170: incl. head insulator for stranded wire, wire and 10 mm tape - also for twisting the stranded wire



Ref. no.	Colour	Total height	Length ground nail	Material ground nail	Eyelets	MOQ	Pieces / unit			€
44417	green	114.5 cm	19 cm	galvanised metal	1 x Poly wire, 2 x Rope, 4 x tape (20 mm), 2 x tape (40 mm)	1 pack	5 / pack	1/5		390
44418	green	158 cm	19 cm	galvanised metal	4 x Rope, 4 x tape (20 mm), 4 x tape (40 mm)	4 pack	5 / pack	1/5/20		360
444170	white	114.5 cm	19 cm	galvanised metal	1 x Poly wire, 2 x Rope, 4 x tape (20 mm), 2 x tape (40 mm)	1 pack	5 / pack	1/5		390
444180	white	158 cm	19 cm	galvanised metal	4 x Rope, 4 x tape (20 mm), 4 x tape (40 mm)	4 pack	5 / pack	1/5/20		360

## Plastic Post Premium

- made from sturdy, impact resistant plastic
- nearly indestructible single tread bar
- with an especially long and reinforced 9 mm thick ground nail
- for all conventional tapes, poly wires, ropes and wires
- vertically reinforced for increased stability
- with single step

441813: incl. head insulator for poly wire, wire and 10 mm tape - also for twisting the poly wire



Ref. no.	Colour	Total height	Length ground nail	Material ground nail	Eyelets	MOQ	Pieces / unit			€
441813	white	107 cm	20 cm	galvanised metal	1 x Poly wire, 2 x Rope, 5 x tape (20 mm), 2 x tape (40 mm)	1 pack	5 / pack	1/5		675
441814	white	147 cm	20 cm	galvanised metal	4 x rope (6 mm), 5 x tape (20 mm), 4 x tape (40 mm)	4 pack	5 / pack	1/5/20		660

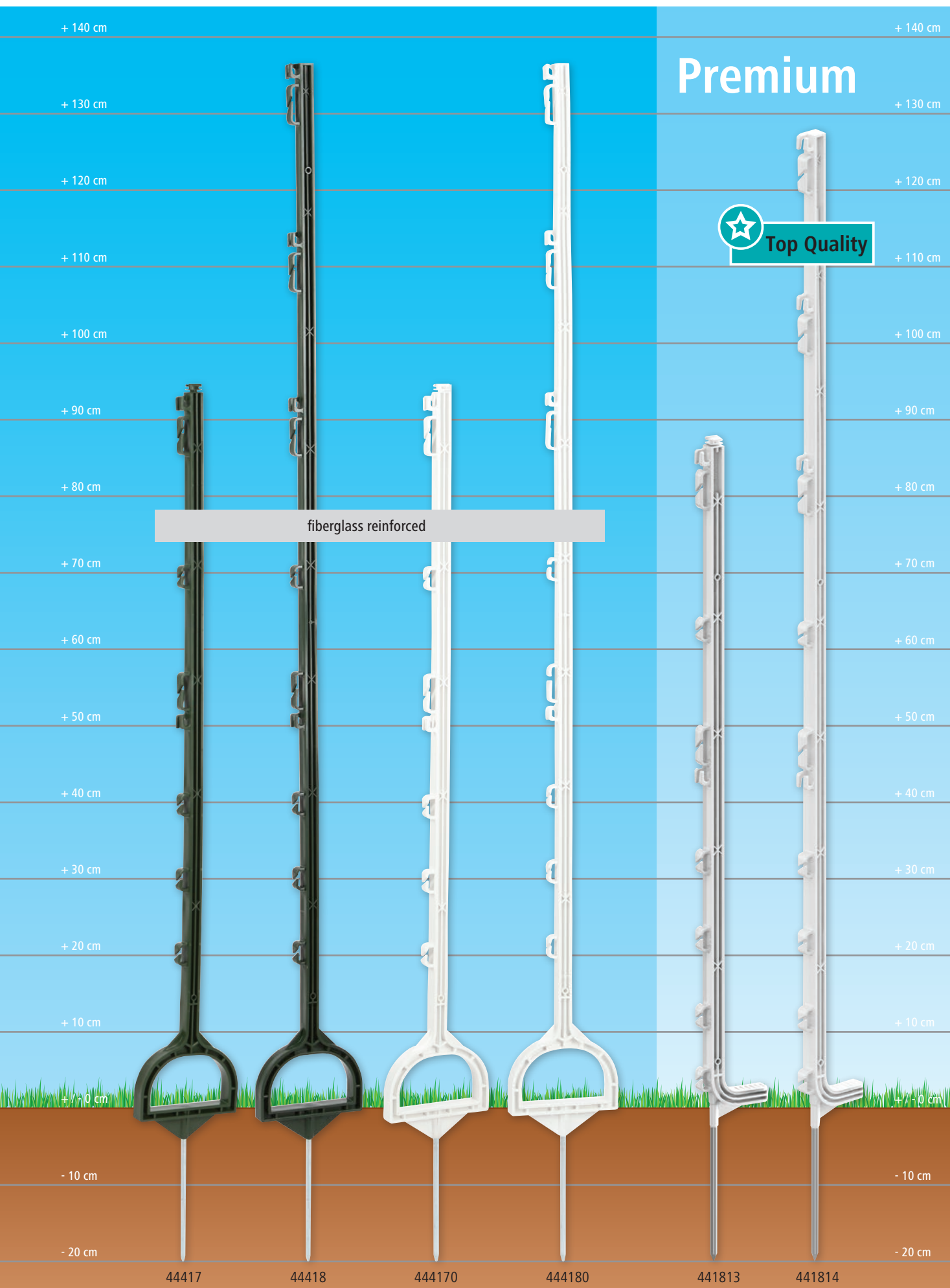



with special honey-comb structure



## Plastic Post Titan Plus

- highly impact-resistant, high-grade plastic, virtually unbreakable
- also suited for sub-zero temperatures
- for all conventional tapes, poly wires, ropes and wires
- vertically reinforced for increased stability
- with galvanised ground nail
- with single step



3 year warranty of UV stability



metal step-in reinforcement provides extremely high stability

Ref. no.	Colour	Total height	Length ground nail	Material ground nail	Eyelets	MOQ	Pieces / unit			€
4418083	blue	110 cm	16 cm	galvanised metal	5 x Rope, 1 x tape (20 mm), 2 x tape (40 mm)	1 pack	5 / pack	1/5		490
441808	white	110 cm	16 cm	galvanised metal	5 x Rope, 1 x tape (20 mm), 2 x tape (40 mm)	1 pack	5 / pack	1/5		490
441809	white	157 cm	19 cm	galvanised metal	7 x Rope, 1 x tape (20 mm), 4 x tape (40 mm)	4 pack	5 / pack	1/5/20		500

## Plastic Post Titan

- highly impact-resistant, high-grade plastic, virtually unbreakable
- also suited for sub-zero temperatures
- for all conventional tapes, poly wires, ropes and wires
- vertically reinforced for increased stability
- with galvanised ground nail
- with single step



3 year warranty of UV stability



Ref. no.	Colour	Total height	Length ground nail	Material ground nail	Eyelets	MOQ	Pieces / unit			€
441802	white	110 cm	18 cm	galvanised metal	5 x Rope, 1 x tape (20 mm), 2 x tape (40 mm)	1 pack	5 / pack	1/5		490

## Plastic Post Titan

- highly impact-resistant, high-grade plastic, virtually unbreakable
- also suited for sub-zero temperatures
- for all conventional tapes, poly wires, ropes and wires
- vertically reinforced for increased stability
- with galvanised ground nail
- with double step



3 year warranty of UV stability



Ref. no.	Colour	Total height	Length ground nail	Material ground nail	Eyelets	MOQ	Pieces / unit			€
441800	white	110 cm	18 cm	galvanised metal	5 x Rope, 1 x tape (20 mm), 2 x tape (40 mm)	1 pack	5 / pack	1/5		350
441801	white	157 cm	21 cm	galvanised metal	7 x Rope, 1 x tape (20 mm), 4 x tape (40 mm)	4 pack	5 / pack	1/5/20		500

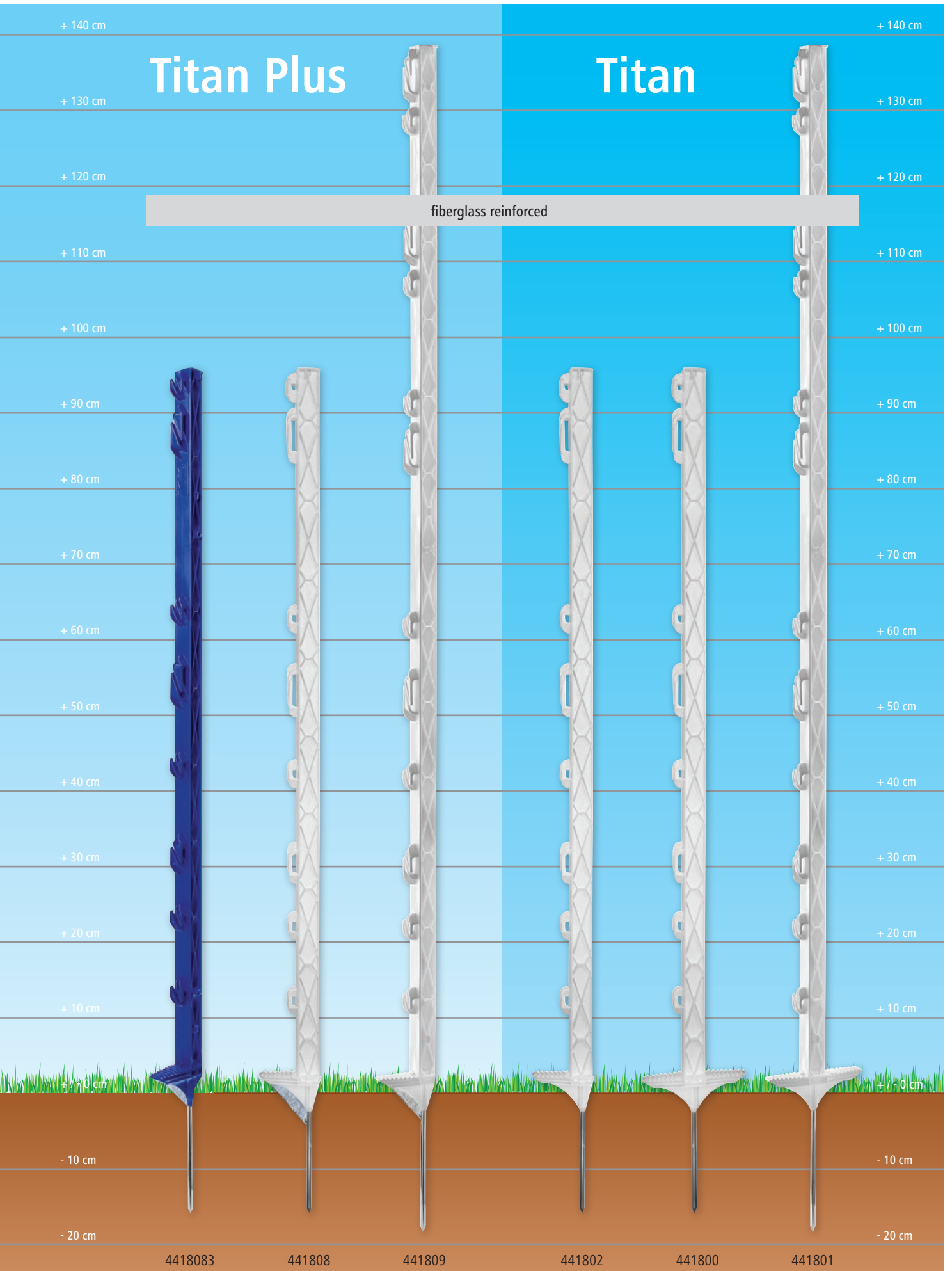

## Plastic Post Expert

### with single step

- for all conventional tapes, poly wires, ropes and wires
- vertically reinforced for increased stability
- with galvanised ground nail
- with single step



3 year warranty of UV stability



NEW: all Expert plastic posts now with even more robust step!

Ref. no.	Colour	Total height	Length ground nail	Material ground nail	Eyelets	MOQ	Pieces / unit			€
443421	white	105 cm	18 cm	galvanised metal	2 x Rope, 3 x tape (20 mm), 2 x tape (40 mm)	1 pack	5 / pack	1/5		630
443412	white	156 cm	21 cm	galvanised metal	4 x Rope, 3 x tape (20 mm), 4 x tape (40 mm)	4 pack	5 / pack	1/5/30		750

## Plastic Post Expert

### with double step

- for all conventional tapes, poly wires, ropes and wires
- vertically reinforced for increased stability
- with galvanised ground nail
- with double step



3 year warranty of UV stability



NEW: all Expert plastic posts now with even more robust step!

Ref. no.	Colour	Total height	Length ground nail	Material ground nail	Eyelets	MOQ	Pieces / unit			€
443422	white	105 cm	18 cm	galvanised metal	2 x Rope, 3 x tape (20 mm), 2 x tape (40 mm)	1 pack	5 / pack	1/5		485
443422/1120	white	105 cm	18 cm	galvanised metal	2 x Rope, 3 x tape (20 mm), 2 x tape (40 mm)	112 pack	10 / pack	1/10		1,120
443422-RE	anthracite	105 cm	18 cm	galvanised metal	2 x Rope, 3 x tape (20 mm), 2 x tape (40 mm)	1 pack	5 / pack	1/5		485
443423	blue	105 cm	18 cm	galvanised metal	2 x Rope, 3 x tape (20 mm), 2 x tape (40 mm)	1 pack	5 / pack	1/5		485
443492	white	125 cm	21 cm	galvanised metal	3 x Rope, 3 x tape (20 mm), 3 x tape (40 mm)	4 pack	5 / pack	1/5/20		500
443493	white	156 cm	21 cm	galvanised metal	4 x Rope, 3 x tape (20 mm), 4 x tape (40 mm)	4 pack	5 / pack	1/5/20		500
443493/40	white	156 cm	21 cm	galvanised metal	4 x Rope, 3 x tape (20 mm), 4 x tape (40 mm)	1 box	40 / box	1		9
443493/1050	white	156 cm	21 cm	galvanised metal	4 x Rope, 3 x tape (20 mm), 4 x tape (40 mm)	105 pack	10 / pack	1/10		1,050
4434932	green	156 cm	21 cm	galvanised metal	4 x Rope, 3 x tape (20 mm), 4 x tape (40 mm)	4 pack	5 / pack	1/5/20		500
4434937	petrol	156 cm	21 cm	galvanised metal	4 x Rope, 3 x tape (20 mm), 4 x tape (40 mm)	4 pack	5 / pack	1/5/20		500
4434938	pink	156 cm	21 cm	galvanised metal	4 x Rope, 3 x tape (20 mm), 4 x tape (40 mm)	4 pack	5 / pack	1/5/20		500



## Expert

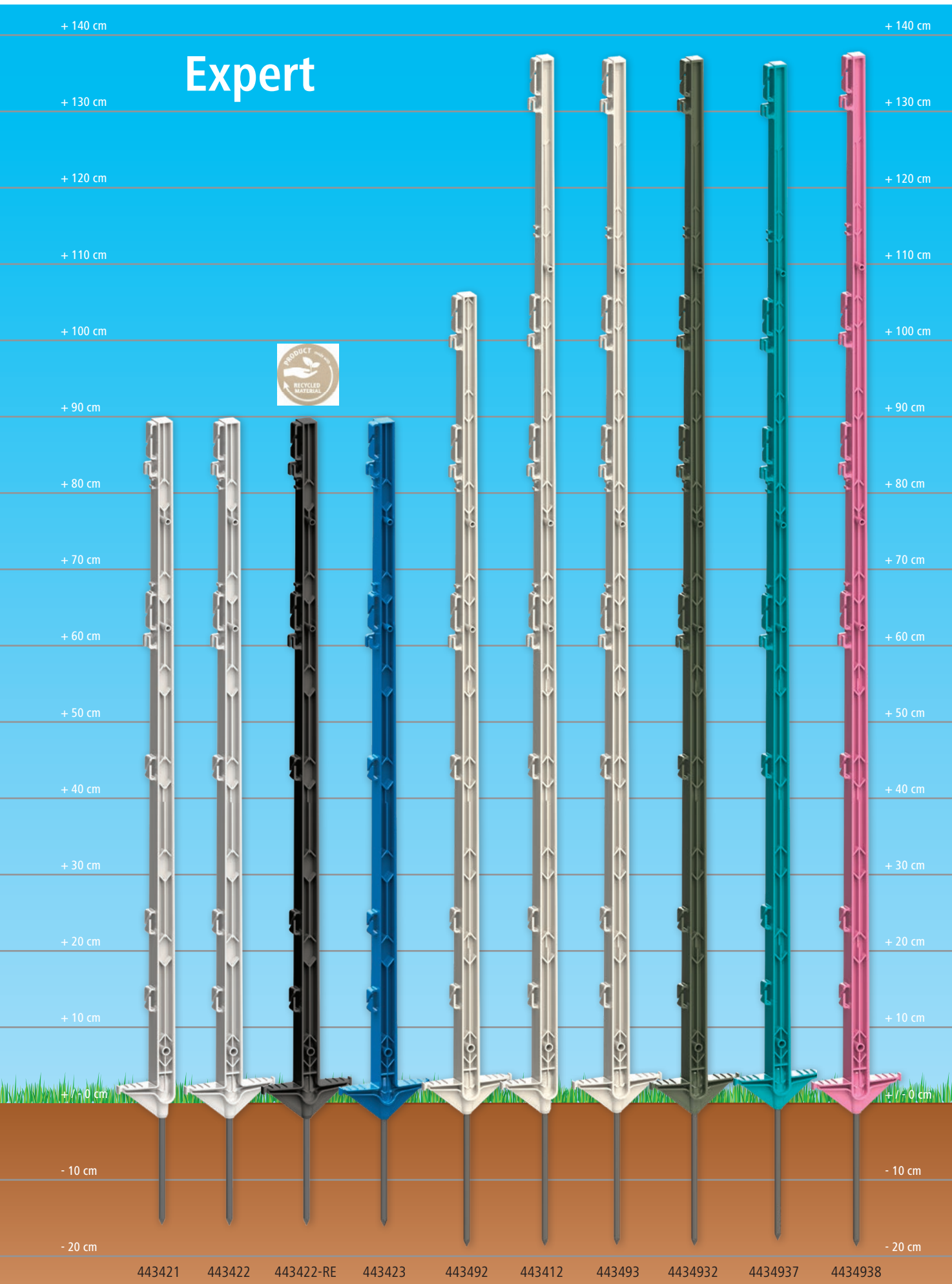

443421 443422 443422-RE 443423 443492 443412 443493 4434932 4434937 4434938

## Plastic Post Basic

- for all conventional tapes, poly wires, ropes and wires
- vertically reinforced for increased stability
- with galvanised ground nail



3 year warranty of UV stability



Ref. no.	Description	Colour	Total height	Length ground nail	Material ground nail	Eyelets	MOQ	Pieces / unit			€
44491	with double step	white	105 cm	17 cm	galvanised metal	5 x Rope, 2 x tape (20 mm), 1 x tape (40 mm)	1 pack	5 / pack	1/5		560

## Plastic Post Eco

- for all conventional tapes, poly wires, ropes and wires
- vertically reinforced for increased stability
- with galvanised ground nail
- with single step



Ref. no.	Colour	Total height	Length ground nail	Material ground nail	Eyelets	MOQ	Pieces / unit			€
441810	white	70 cm	18 cm	galvanised metal	5 x tape (20 mm)	1 pack	5 / pack	1/5		1,200
4418102	green	70 cm	18 cm	galvanised metal	5 x tape (20 mm)	1 pack	5 / pack	1/5		1,200
441812	white	105 cm	18 cm	galvanised metal	7 x tape (20 mm), 1 x tape (40 mm)	1 pack	5 / pack	1/5		1,000

## Plastic Post

- with galvanised ground nail



5 year UV stability warranty



Ref. no.	Description	Colour	Total height	post Ø	Length ground nail	Material ground nail	MOQ	Pieces / unit			€
44400	no tread	white	108 cm	19 mm	23 cm	galvanised metal	1 pack	10 / pack	1/10		1,000
44405	with single step	white	108 cm	19 mm	26 cm	galvanised metal	1 pack	10 / pack	1/10		1,000
44499	with single step	white	158 cm	19 mm	26 cm	galvanised metal	1 pack	10 / pack	1/10		

Ref. no.	Description	Colour	Material	Ø	MOQ	Pieces / unit		€
44403	Additional Eyelet for Plastic Post for wire, poly wire, rope and 10 mm tape	white	PVC	19 mm	1 pouch	25 / pouch	1/25/1000	
44404	Additional Eyelet for Plastic Post tape up to 40 mm	white	PVC	19 mm	1 pouch	25 / pouch	1/25/750	

# Plastic Posts and Accessories

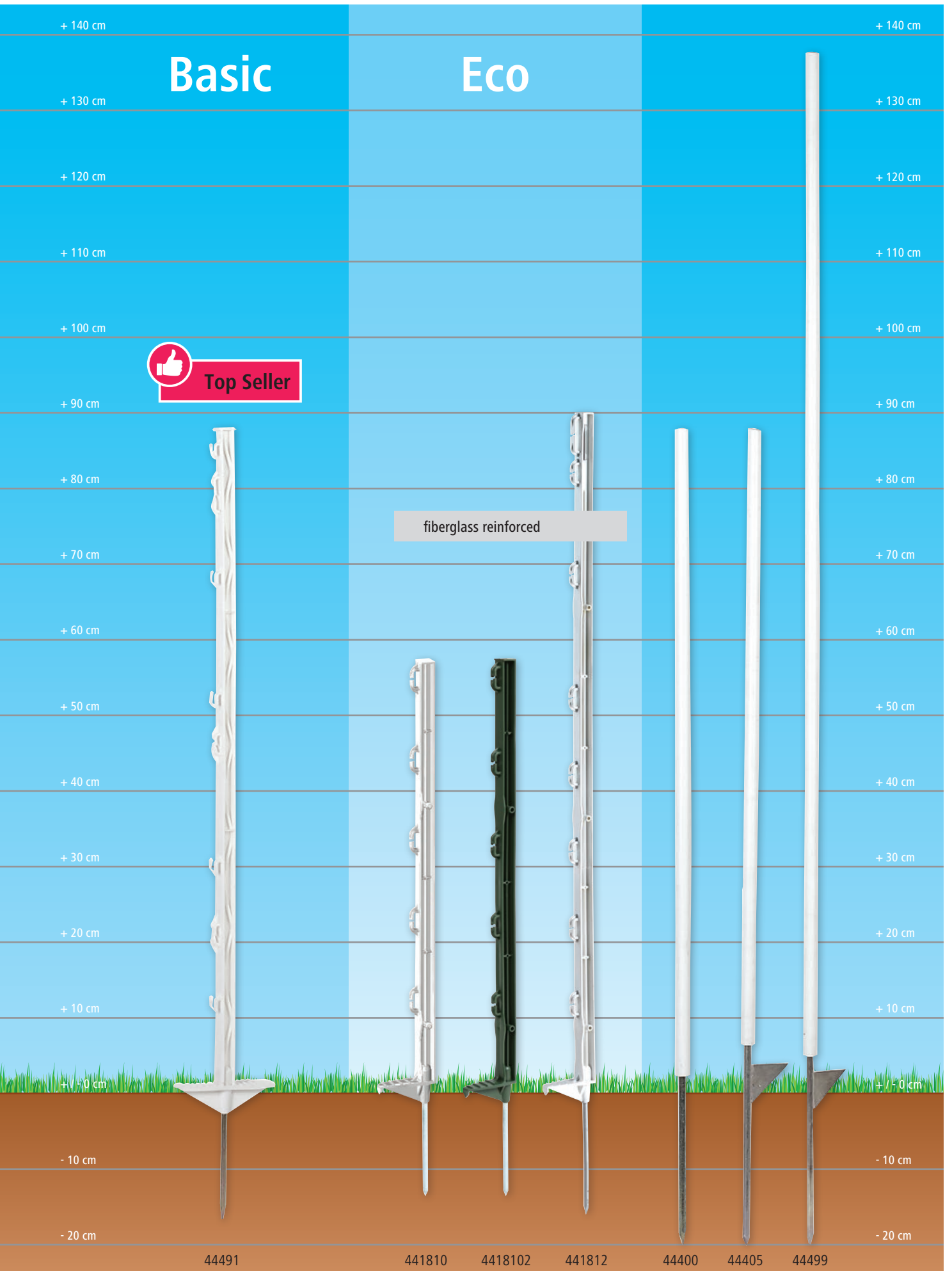



# Insulators



Insulators separate the conductor material from the post and prevent unwanted discharge into the ground. There are insulators for each area of application, specially developed for each conductor material or the various types of post.

For most insulators, the following applies: the larger the insulator, the better its insulating properties. For corners and junctions, extra robust insulators should be used because there are high tensile forces here that put high stress on the material. Along with their insulating properties, our insulators also make it easier to work with the various conductor materials. For example, with the right insulator, you can re-tension sagging conductor material with just a few actions or take care of partially torn tapes for re-electrification.

## We divide our insulators into the following types of applications:

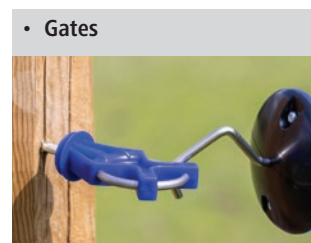
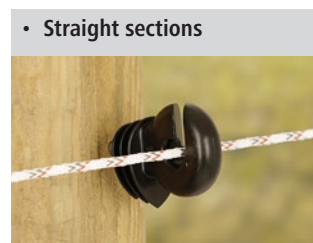
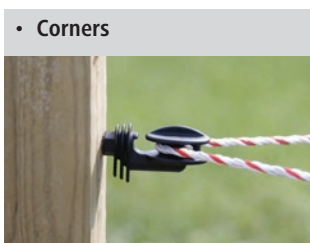

## Wood Screw

- hexagon round head
- for securing insulators
- incl. bit insert TX25
- 4.5 x 35 mm galvanised
- Thread type: with wood thread



Ref. no.	Length	MOQ	Pieces / unit		€
442610/1001	35 mm	1 pack	100 / pack	1	

## Ring Insulator Easy Drill SX *green*

- Insulator made of sustainable bio-based plastic - from 100 % renewable raw materials
- wood look thanks to small natural wood chips in the bio-plastic
- extremely robust and impact-resistant
- best possible insulation properties
- high-quality wood screw (5 x 80 mm) is enclosed separately and enables quick and easy mounting of the insulator using a cordless screwdriver (no separate screwdriver required)
- 100 % recyclable - at the end of the product's life, the bio-plastic insulator and screw can be separated and recycled separately
- packaging made from 100 % recycled cardboard
- Suitable for: Poly wire, Rope, tape up to 10 mm

Made in Germany

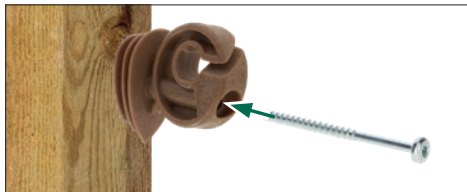

Ref. no.	Colour	MOQ	Pieces / unit		€
44377/502	brown	1 pack	50 / pack	1/10	

## Ring insulator with continuous support incl. screw-in screwdriver in robust stable/construction bucket

So that you always have our top-selling insulator to hand - supplied in a jumbo bucket that can be reused as a practical construction or stable bucket.

- Free screwdriver!
- with wide wire support
- Material: Plastic
- with wood thread
- with continuous galvanised support  $\varnothing$  5,3 mm
- Suitable for: Poly wire, Rope, tape up to 10 mm



supplied in a durable, robust 12-litre stable/construction bucket with transparent lid and free screwdriver!

Included in delivery: 1 x stable/construction bucket, 1 x transparent lid, 250 x ring insulator, 1 x screwdriver



Ref. no.	MOQ	Pieces / unit		€
44314/2503E	1 bucket	250 / bucket	1	

## Ring Insulator

- with wide wire support
- plastic made from recycled material with same quality standard
- packaging box made from recycled cardboard
- with wood thread
- with continuous galvanised support  $\varnothing$  5,3 mm
- Suitable for: Poly wire, Rope, tape up to 10 mm



Ref. no.	Colour	MOQ	Pieces / unit		€
44314/100-RE	anthracite	1 pack	100 / pack	1	



# Ring Insulators with continuous support

The long support runs through the insulating plastic body, which makes these insulators particularly robust.

## EDX - the self-cutting thread

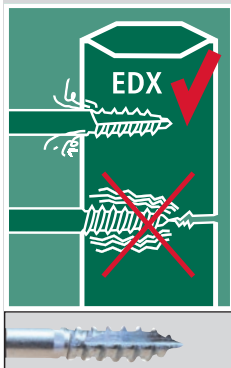

## Ring Insulator Easy Drill EDX with continuous support

- 2 x as easy to screw in as standard supports – the wood is 'cut' not 'displaced'
- no need for pre-drilling for hard wood
- far less fracturing in wood when screwed in
- best possible insulation properties
- Material: impact-resistant plastic
- with self-cutting wooden thread EDX
- with continuous galvanised support  $\varnothing$  6 mm
- Suitable for: Wire, Poly wire, Rope, tape up to 10 mm

443269/753E: with free screwdriver



Ref. no.	Colour	MOQ	Pieces / unit		€
443269	black	1 pouch	25 / pouch	1/25/500	
443269/201	black	1 pack	20 / pack	1/14	
443269/753E	black	1 bucket	75 / bucket	1	

## Ring Insulator

- with wide wire support
- Material: Plastic
- with wood thread
- with continuous galvanised support  $\varnothing$  5,3 mm
- Suitable for: Poly wire, Rope, tape up to 10 mm

44314/1003E: with free screwdriver

44314/2603E: with free screwdriver

44314/3003E: with free screwdriver



Ref. no.	Colour	MOQ	Pieces / unit		€
44314	black	1 pouch	25 / pouch	1/25/500	
44314/251	black	1 pack	25 / pack	1/14	
449314	black	1 pouch	50 / pouch	1/50/500	
44314/1003E	black	1 bucket	100 / bucket	1	
44314/2603E	black	1 bucket	260 / bucket	1	
44314/3003E	black	1 bucket	300 / bucket	1	

## Screwdriver for Ring and Clip Insulator

- for drills and battery screwdrivers • easily screwed in due to its round shape • Material: Plastic

also suitable for Maxi Tape insulator 441390 and Allgäu 441381 as well as ring insulators

Ref. no.	Pieces / unit		€
441363/011	1 / pack	1	

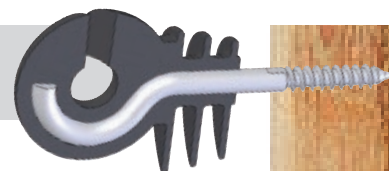



# Ring Insulators with short support

The short support allows generous use of plastic material and therefore offers very good insulating properties.

## EDX - the self-cutting thread

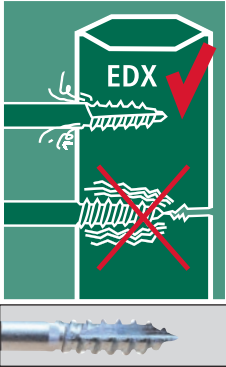

## Ring Insulator Easy Drill EDX

- 2 x as easy to screw in as standard supports – the wood is 'cut' not 'displaced'
- no need for pre-drilling for hard wood
- far less fracturing in wood when screwed in
- best possible insulation properties
- Material: impact-resistant plastic
- with wood thread
- with short galvanised support Ø 6 mm
- Suitable for: Wire, Poly wire, Rope, tape up to 10 mm

443279/903E: with free screwdriver

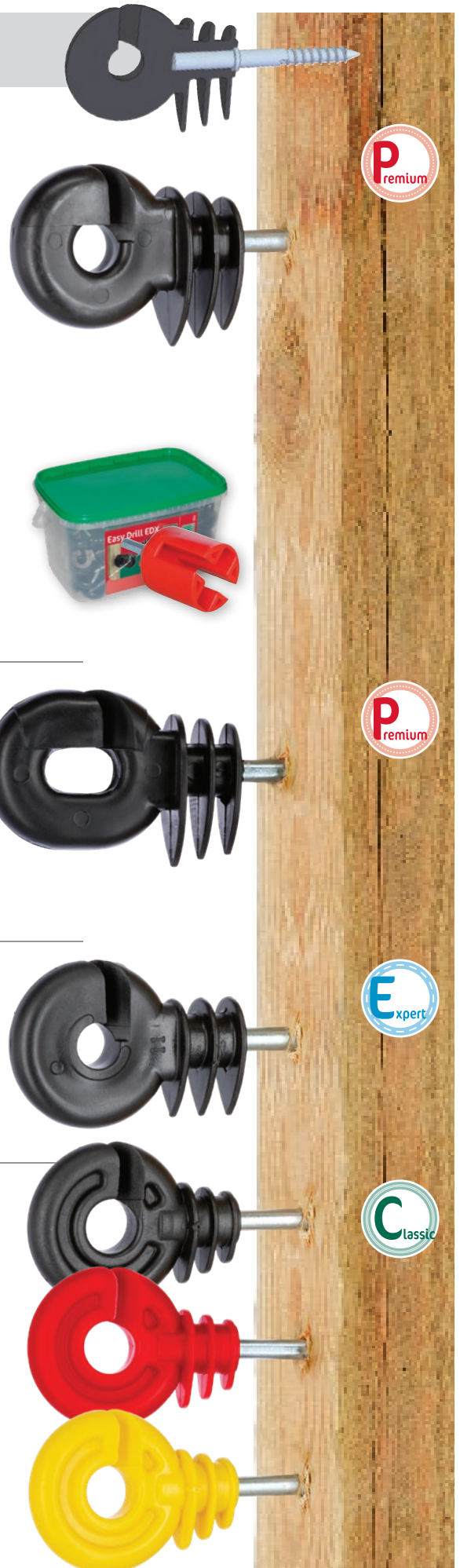

Ref. no.	Colour	MOQ	Pieces / unit		€
443279	black	1 pouch	25 / pouch	1/25/500	
443279/201	black	1 pack	20 / pack	1/14	
443279/903E	black	1 bucket	90 / bucket	1	

## Ring Insulator Premium BIG

- with wide slit for rope
- Material: Plastic
- with wood thread
- with short galvanised support Ø 6 mm
- Suitable for: Wire, Poly wire, Rope, tape up to 10 mm

Ref. no.	Colour	MOQ	Pieces / unit		€
441385	black	1 pack	25 / pack	1/25/500	

## Ring Insulator

- with wide wire support
- Material: Plastic
- with wood thread
- with short galvanised support Ø 6 mm
- Suitable for: Rope, Poly wire, tape up to 10 mm

Ref. no.	Colour	MOQ	Pieces / unit		€
44316	black	1 pouch	25 / pouch	1/25/500	
44316/251	black	1 pack	25 / pack	1/14	
44316/903	black	1 bucket	90 / bucket	1	

## Ring Insulator Compact

- with wide wire support
- Material: Plastic
- with wood thread
- with short galvanised support Ø 5 mm
- Suitable for: Rope, Poly wire, tape up to 10 mm

Ref. no.	Colour	MOQ	Pieces / unit		€
44306	black	1 pouch	25 / pouch	1/25/500	
44306/251	black	1 pack	25 / pack	1/14	
44306/903	black	1 bucket	90 / bucket	1	
44318	red	1 pouch	50 / pouch	1/50/500	
441342	yellow	1 pouch	25 / pouch	1/25/500	

EDX - the self-cutting thread



## Slit Insulators Easy Drill EDX

- extra-stable slit insulator made from high-quality polycarbonate
- made from unbreakable polycarbonate
- suitable for extreme temperature and weather conditions
- best insulating properties thanks to large plastic body
- includes matching screw-in tool (441379)
- Material: Polycarbonate
- with self-cutting wooden thread EDX
- with galvanised support  $\varnothing$  7 mm
- Suitable for: Poly wire, Wire



Free screwdriver!

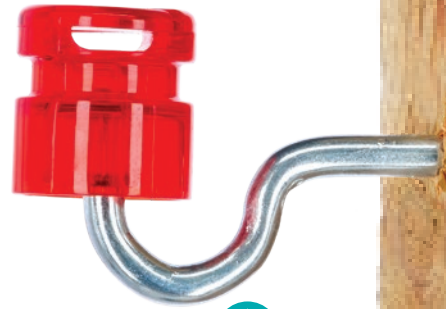

Ref. no.	Colour	MOQ	Pieces / unit		€
441373/503E	red	1 bucket	50 / bucket	1	



## Slit Insulators Premium

- excellent insulation qualities
- Material: Polycarbonate
- with wood thread
- with continuous galvanised support  $\varnothing$  6 mm
- Suitable for: Poly wire, Wire

polycarbonate = highly break-proof and durable!

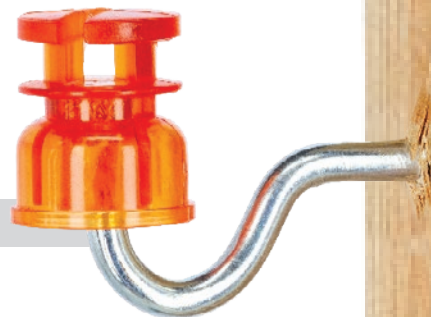

Ref. no.	Colour	MOQ	Pieces / unit		€
44302	orange	1 pouch	25 / pouch	1/25/500	
44302/251	orange	1 pack	25 / pack	1/14	



## Slit Insulators

- excellent insulation qualities
- Material: Plastic
- with wood thread
- with continuous galvanised support  $\varnothing$  5,3 mm
- Suitable for: Poly wire, Wire



Ref. no.	Colour	MOQ	Pieces / unit		€
44300	black	1 pouch	25 / pouch	1/25/500	
44300/301	black	1 pack	30 / pack	1/14	
44305	red	1 pouch	100 / pouch	1/100/1000	



## Combi Insulator Premium

- combines various uses of conductor materials in ONE insulator
- excellent insulation characteristics due to large, wide drip-zones emphasise the high quality of this insulator
- Material: Plastic
- with wood thread
- with short galvanised support  $\varnothing$  6 mm
- Suitable for: Poly wire, Rope, tape up to 20 mm



proven a hundred thousand times over!

Ref. no.	Colour	Support length	MOQ	Pieces / unit		€
441370	red	37 mm	1 pouch	25 / pouch	1/25/500	
441380	black	37 mm	1 pouch	25 / pouch	1/25/500	
441380/351	black	37 mm	1 pack	35 / pack	1/12	
441371	pink	37 mm	1 pouch	25 / pouch	1/25/500	
441372	petrol	37 mm	1 pouch	25 / pouch	1/25/500	

## Winder Insulator Allgäu

- easy to tighten / fix in place by winding the conductor material around the insulator
- Material: impact-resistant plastic, UV-stabilised
- with wood thread
- with short galvanised support
- Suitable for: Poly wire, Wire



can be screwed in using screw aid item no. 441363/011



Ref. no.	Colour	Support length	MOQ	Pieces / unit		€
441381	black	37 mm	1 pouch	25 / pouch	1/25/500	

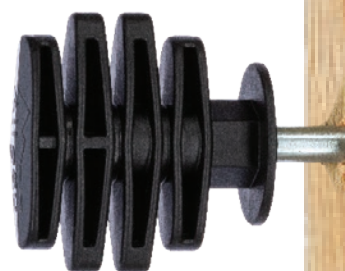



## Corner/Stretch Insulator Premium

- electrically conductive rubber inlays through carbon fibres (patented) secure the tape very gently but reliably
- anti-slip by alternating rubber pad structure
- end or strain insulator, also excellent for corners
- mounts easily and strains tapes without fatigue
- Material: Plastic
- screw-on fastening
- Suitable for: Poly wire, Rope, tape up to 40 mm

Made in Germany



Individual interrupted / broken conductor wires are re-electrified by the electricity-conducting rubber.

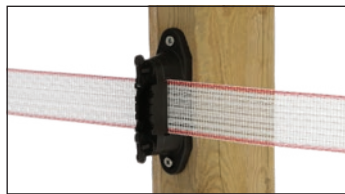
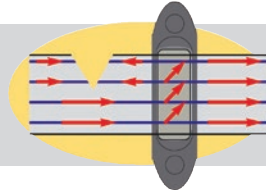

patented

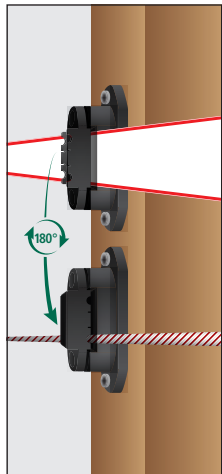

suitable  
wood screws  
442610/1001



Professional tip:  
very popular for  
horse fences!

• Because of the logical further development of our proven Profi corner/stretch insulator, by turning the upper clamping element through 180 degrees it is now also possible to ensure even more secure fastening, especially for fence ropes and wires. • Our Profi is therefore insulator the universal start/corner/stretch insulator, which makes it simple to tighten all conductor materials.

Ref. no.	Colour	MOQ	Pieces / unit		€
443501	black	1 pouch	10 / pouch	1/10/200	
44350/061	black	1 pack	6 / pack	1/50	

## Tape Corner Insulator Cavallo

- extra strong finish, made from very durable polyamide plastic
- free-running tape is fed through safely thanks to smooth, rounded surface
- with wood thread
- with continuous galvanised support Ø 8 mm
- Suitable for: tape up to 40 mm

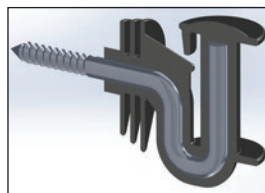

Ref. no.	Colour	MOQ	Pieces / unit		€
441376	black	1 pouch	10 / pouch	1/10/250	
441376/081	black	1 pack	8 / pack	1/50	

## Tape/Rope Tensioner Premium

- easy tape/cable loosening
- simple to add on to existing fence systems
- simple, secure tensioning by hand without tools - thanks to ratchet function
- Material: polyamide glass-fibre reinforced
- screw-on fastening
- Suitable for: rope up to Ø 8 mm, tape up to 40 mm



suitable  
wood screws  
442610/1001



Ref. no.	Colour	MOQ	Pieces / unit		€
44578	black	1 pouch	10 / pouch	1/10/100	
44578/041	black	1 pack	4 / pack	1/14	

## Clip Insulator Premium

- ideal as a stretch insulator and tape tensioner
- Material: plastic, UV-stabilised
- screw-on fastening
- Suitable for: tape up to 40 mm

Made in Germany



Top Seller

• The double-sided, ribbed rubber inlay provides a reliable and protective hold for the tape along with the patented „clip“ functional principle. • The inlay prevents the tape from slipping and protects against damage. The tothing above the rubber inlay prevents the tape from slipping out.



patented

suitable  
wood screws  
442610/1001



Ref. no.	Colour	MOQ	Pieces / unit		€
441290	black	1 pouch	10 / pouch	1/10/200	
441290/141	black	1 pack	14 / pack	1/25	
441290/603	black	1 bucket	60 / bucket	1	



## Clip Insulator Maxi Tape

- improved clip mechanism thanks to 2 locking points
- plastic made from recycled material with same quality standard
- with wood thread
- with galvanised support  $\varnothing$  6 mm
- Suitable for: rope up to  $\varnothing$  6 mm, tape up to 40 mm



Top Seller

patented

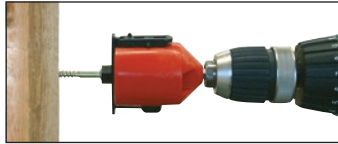

suitable screwdriver  
441363/011

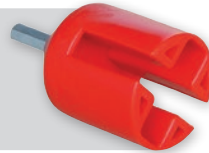

Ref. no.	Colour	Support length	MOQ	Pieces / unit		€
441390	black	37 mm	1 pouch	25 / pouch	1/25/500	
441390/301	black	37 mm	1 pack	30 / pack	1/12	
441390/803	black	37 mm	1 bucket	80 / bucket	1	
441390/50-RE	anthracite	37 mm	1 pack	50 / pack	1	



## Clip Insulator Easy Tape

- improved clip mechanism thanks to 2 locking points
- reinforced screw-on plate
- ideal fence line insulator
- plastic made from recycled material with same quality standard
- screw-on fastening
- Suitable for: rope up to  $\varnothing$  6 mm, tape up to 40 mm

passende  
Holzschrauben  
442610/1001



patented

Ref. no.	Colour	MOQ	Pieces / unit		€
441391	black	1 pouch	25 / pouch	1/25/500	
441391/251	black	1 pack	25 / pack	1/12	
441391/753	black	1 bucket	75 / bucket	1	
441391/50-RE	anthracite	1 pack	50 / pack	1	



## Corner insulator

- screw in or nail on

44347: for tapes 40 - 60 mm  
44348: for forking fences off in different directions for 40 mm tapes

suitable  
wood screws  
442610/1001



44348

**Important: Not suitable for tapes with copper wires!**

Ref. no.	Description	Colour	MOQ	Pieces / unit		€
44347	without additional bracket	black	1 pouch	10 / pouch	1/10/100	
44348	with spare bracket	black	1 pouch	10 / pouch	1/10/100	





## Insulator Euro Tape

- easy tape installation possible
- Material: Plastic
- with wood thread
- with galvanised support Ø 6 mm
- Suitable for: tape up to 40 mm

New product

NEW

Ref. no.	Colour	MOQ	Pieces / unit		€
44380	black	1 pouch	25 / pouch	1/25/500	

## Wide Tape Ring Insulator

- Material: Plastic • with wood thread • with galvanised support Ø 6 mm
- Suitable for: tape up to 20 mm

Our most popular wide tape ring insulator for 20 mm tapes!

Ref. no.	Colour	MOQ	Pieces / unit		€
44309	black	1 pouch	25 / pouch	1/25/500	
44309/151	black	1 pack	15 / pack	1/14	

## Wide Tape Insulator

- solid and durable type • tape passes through – thus easy straining of hot tape over longer runs of fence • Material: Plastic • screw in or nail on • Suitable for: tape up to 40 mm

ideal in combination with corner/stretch insulator

suitable wood screws  
442610/1001

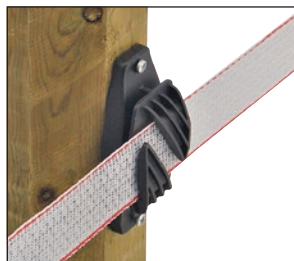

Ref. no.	Colour	MOQ	Pieces / unit		€
44340	black	1 pouch	10 / pouch	1/10/200	
44340/121	black	1 pack	12 / pack	1/12	

## Wide Tape Insulator Compact

- solid and durable type • tape passes through – thus easy straining of hot tape over longer runs of fence • Material: Plastic • screw in or nail on • Suitable for: tape up to 20 mm

ideal in combination with corner/stretch insulator

suitable wood screws  
442610/1001

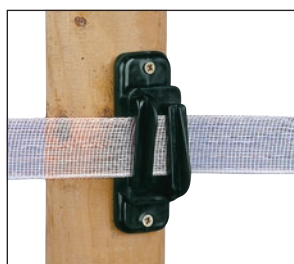

Ref. no.	Colour	MOQ	Pieces / unit		€
44343	black	1 pouch	10 / pouch	1/10/200	



# Rope/Wire Insulators

## Rope Insulator Easy Cord

- Material: impact-resistant plastic
- with wood thread
- with galvanised support Ø 6 mm
- Suitable for: rope up to Ø 8 mm, Poly wire

441382/703E: Screw-in Tool Set (item no. 441384) is included with the promotional bucket



10 year UV stability warranty



Ref. no.	Colour	Support length	MOQ	Pieces / unit		€
441382	black	38 mm	1 pouch	25 / pouch	1/25/500	
441382/301	schwarz	38 mm	1 pack	30 / Blister	1/12	
441382/703E	black	38 mm	1 bucket	70 / bucket	1	

## Rope Insulator Euro Cord

extremely robust insulator made from break-proof plastic

- screw in or nail on
- Suitable for: Poly wire, rope up to Ø 8 mm, tape up to 10 mm, TopLine Horse Wire, Premium Horse Wire

ideal for Premium Horse Wire and TopLine Horse Wire

suitable wood screws  
442610/1001

10 year UV stability warranty



Ref. no.	Colour	MOQ	Pieces / unit		€
441396	black	1 pouch	10 / pouch	1/10/200	
441396/201	black	1 pack	20 / pack	1/12	
441396/503	black	1 bucket	50 / bucket	1	



## Permanent Fencing Insulator Highland

- professional insulator for permanent fencing
- ideal for steel wires
- Material: Plastic
- screw in or nail on
- Suitable for: Wire, Poly wire up to Ø 2.5 mm

suitable wood screws  
442610/1001

10 year UV stability warranty



Ref. no.	Colour	MOQ	Pieces / unit		€
441398	black	1 pouch	10 / pouch	1/10/200	



## Insulator Pinlock

- heavy-duty insulator
- Material: Plastic
- screw in or nail on
- Suitable for: steel wire 1.0 - 2.0 mm, Poly wire, rope up to Ø 8 mm

suitable wood screws  
442610/1001

Ref. no.	Colour	MOQ	Pieces / unit		€
4414951	black	1 pack	25 / pack	1/25/500	



## Corner insulator Premium

- extra-strong design, highly robust
- polyamide plastic for high tensile forces
- electrical discharges effectively do not arise, partly through the highly insulated post and partly through the special form of the insulator, which prevents the conductor material slipping on the metal support
- with wood thread
- with continuous galvanised support Ø 8 mm
- Suitable for: Rope, Poly wire, Wire, tape up to 10 mm

Ref. no.	Colour	MOQ	Pieces / unit		€
441330	black	1 pouch	10 / pouch	1/10/250	
441330/061	black	1 pack	6 / pack	1	

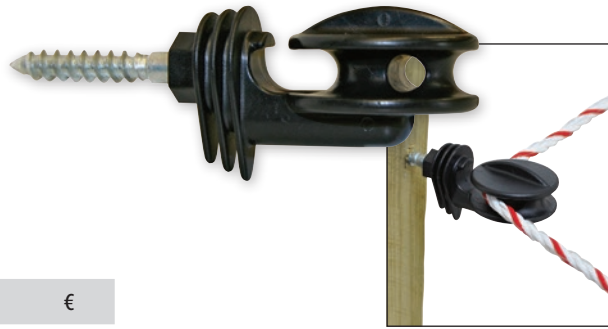

The perfect corner solution

## polyamide de-tensioning insulator for steel wire

- suitable as corner and strain insulator in permanent fencing (plain wire)
- Material: polyamide glass-fibre reinforced
- Suitable for: steel wire, Poly wire, Rope, Premium Horse Wire, TopLine Horse Wire

Ref. no.	Colour	MOQ	Pieces / unit		€
443581	white	1 pouch	10 / pouch	1/10/250	

resists especially high strains



## Corner / Strain Insulator

with metal insert

- extremely durable starting and end insulator for fence wires
- incorporated metal insert can withstand extreme tensile loads and prevents the wire "cutting into" the insulator
- Material: Plastic

Ref. no.	Colour	MOQ	Pieces / unit		€
442370	black	1 pouch	10 / pouch	1/10/200	

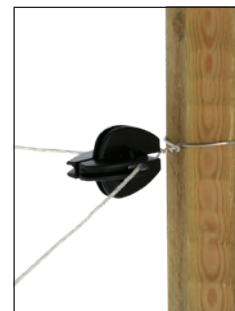

## De-tensioning Isolator for Electric Rope

- important aid in fence construction
- Suitable for: Wire, Poly wire, Rope

Ref. no.	Colour	MOQ	Pieces / unit		€
443341	white	1 pouch	25 / pouch	1/25/250	
44334/061	white	1 pack	6 / pack	1/50	
443351	black	1 pouch	25 / pouch	1/25/250	

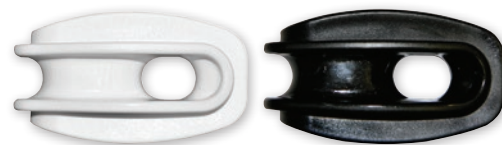

## Corner Insulator for Wire and Rope

- reinforced design
- Fully rotatable roll
- Material: Plastic
- with wood thread
- with galvanised support Ø 7 mm
- Suitable for: Poly wire, Rope

Ref. no.	Colour	MOQ	Pieces / unit		€
44330	black	1 pouch	25 / pouch	1/25/250	





# Insulators with metric thread

## Corner insulator Premium

- extra strong finish made from polyamide plastic (PA)
- no slipping of the conductive material on the metal support thanks to the insulator's special shape
- Material: Polyamide
- with metric thread
- with continuous galvanised support  $\varnothing$  8 mm
- Suitable for: Rope, Poly wire, Wire
- 2 nuts included

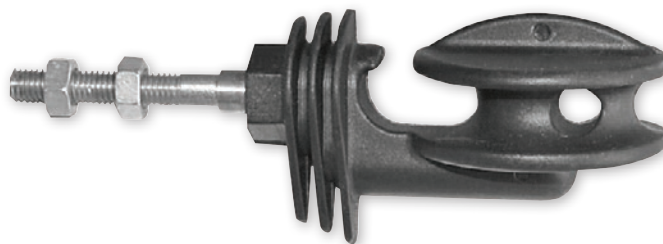

Ref. no.	Colour	Thread	Thread length	MOQ	Pieces / unit		€
441360	black	M6	30 mm	1 pouch	10 / pouch	1/10/250	

## Offset Ring Insulator

- suitable as a spacer
- Material: Plastic
- with metric thread
- with galvanised support  $\varnothing$  6 mm
- Suitable for: Poly wire, Rope, tape up to 10 mm
- 2 nuts included

with short support



Ref. no.	Colour	Support length	Thread	Thread length	MOQ	Pieces / unit		€
442376	black	200 mm	M6	100 mm	1 pack	10 / pack	1/10/300	

## Ring Insulator

- Material: Plastic
- with metric thread
- with short galvanised support  $\varnothing$  6 mm
- Suitable for: Poly wire, Rope, tape up to 10 mm
- 2 nuts included



with short support



Ref. no.	Description	Colour	Thread	Thread length	MOQ	Pieces / unit		€
44324	for metal post	black	M6	35 mm	1 pouch	25 / pouch	1/25/500	
44324/201	for metal post	black	M6	35 mm	1 pack	20 / pack	1/14	
44391	for tubular pole	black	M6	80 mm	1 pouch	25 / pouch	1/25/500	

## Tape Corner Insulator Cavallo

- extra strong finish made from polyamide plastic (PA)
- free-running tape is fed through safely thanks to smooth, rounded surface
- with metric thread
- with continuous galvanised support  $\varnothing$  8 mm
- Suitable for: tape up to 40 mm
- 2 nuts included

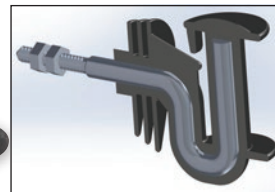
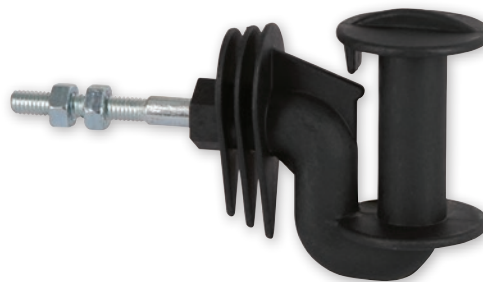

Ref. no.	Colour	Thread	Thread length	MOQ	Pieces / unit		€
441377	black	M6	30 mm	1 pouch	10 / pouch	1/10/250	

## Gate / start insulator

- for attaching gate handles on both sides
- Material: Plastic
- with metric thread
- with galvanised support  $\varnothing$  6 mm
- 2 nuts included



Ref. no.	Colour	Thread	Thread length	MOQ	Pieces / unit		€
441241	black	M6	25 mm	1 pouch	10 / pouch	1/10/250	

## Clip Insulator

- Material: Plastic
- with metric thread
- with short galvanised support  $\varnothing$  6 mm
- Suitable for: rope up to  $\varnothing$  6 mm, tape up to 40 mm
- 2 nuts included

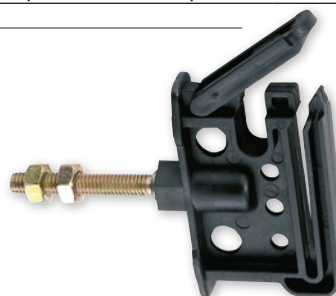

Ref. no.	Colour	Thread	Thread length	MOQ	Pieces / unit		€
441392	black	M6	35 mm	1 Beutel	25 / pouch	1/25/500	

## Long-Handle Clip Insulator

- suitable as a spacer
- Material: Plastic
- with metric thread
- with short galvanised support  $\varnothing$  6 mm
- Suitable for: Poly wire, Rope, tape up to 40 mm
- 2 nuts included

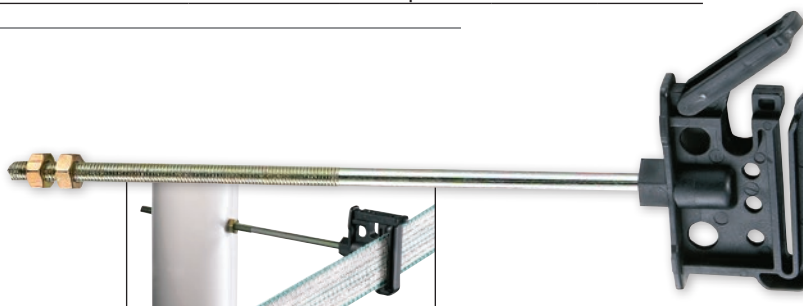

Ref. no.	Colour	Support length	Thread	Thread length	MOQ	Pieces / unit		€
441393	black	200 mm	M6	100 mm	1 pouch	10 / pouch	1/10/300	

## Mounting Clamp for Round Posts

- for 35 - 70 mm round posts
- incl. rubber inlay to protect the posts
- to fasten insulators with metric thread M6

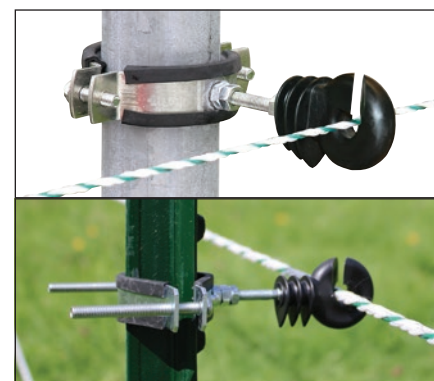
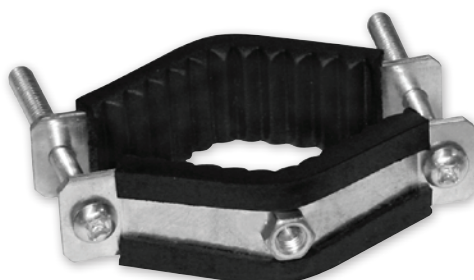

Art. Nr.		€
441276	1/20/120	



## Screw Insulator Vario Plus

- for metal or plastic posts up to  $\varnothing$  17 mm
- mounted on side of post and easily tightened
- heavy-duty quality
- Material: impact-resistant plastic

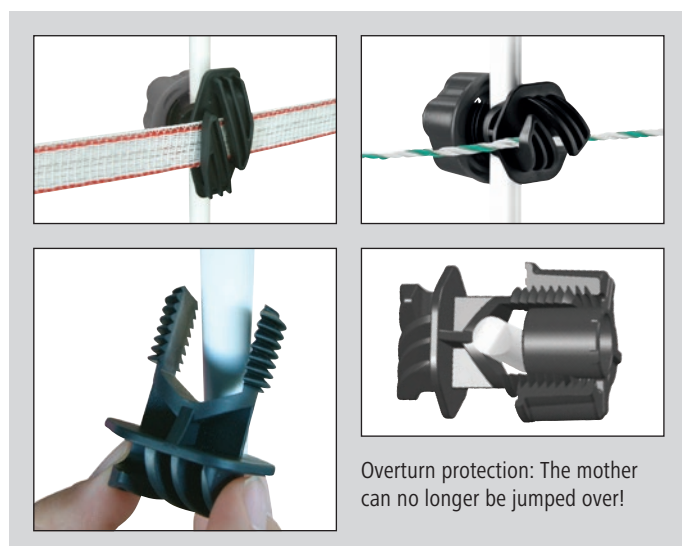

Overturn protection: The mother can no longer be jumped over!

Ref. no.	Description	Colour	MOQ	Pieces / unit		€
441386	for tapes up to 40 mm	black	1 pouch	10 / pouch	1/10/200	
441386/151	for tapes up to 40 mm	black	1 pack	15 / pack	1/22	
441387	for wire, poly wire, rope and 10 mm tape	black	1 pouch	10 / pouch	1/10/200	
441387/201	for wire, poly wire, rope and 10 mm tape	black	1 pack	20 / pack	1/12	

## Ring Insulator Vario Classic

- for metal or plastic posts from 7 to 19 mm diameter
- fast and tool-free installation
- easy to tighten / fix in place by winding the conductor material around the insulator
- Material: impact-resistant plastic
- Suitable for: Poly wire, Rope, tape up to 10 mm



Ref. no.	Colour	MOQ	Pieces / unit		€
445595	black	1 pouch	10 / pouch	1/10/200	
445595/141	black	1 pack	14 / pack	1/22	





## Nail Insulator

- Material: Plastic
- nail-in
- Suitable for: Wire, Poly wire
- Supplied with nails

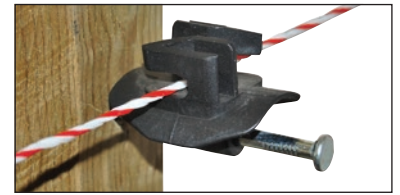
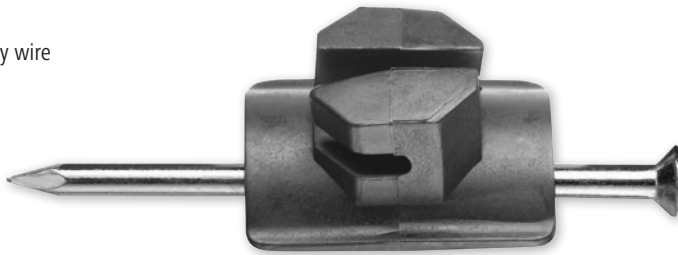

Ref. no.	Description	Colour	MOQ	Pieces / unit		€
44367	with 7 cm nails	black	1 pouch	50 / pouch	1/50/700	
44368	with 10 cm nails	black	1 pack	50 / pack	1/50/400	

## Nail Insulator

- with knob
- Material: Plastic
- nail-in
- Suitable for: Wire, Poly wire
- delivery without nail

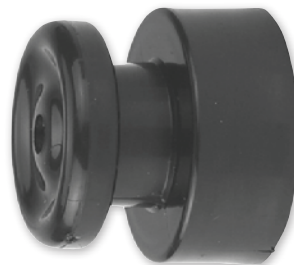

Ref. no.	Colour	MOQ	Pieces / unit		€
44360	black	1 pack	100 / pack	1/100/1800	

## Nail Insulator

- Material: Plastic
- nail-in
- Suitable for: Wire, Poly wire
- delivery without nail

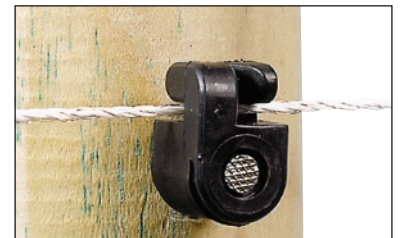

Ref. no.	Colour	MOQ	Pieces / unit		€
44361	black	1 pack	100 / pack	1/100/1800	

## Charge insulator for round and oval steel posts

- simply hammer onto metal/fibreglass poles or structural steel poles (round or oval with a diameter of 6-12 mm) to the desired height and pull in the conductor material
- especially robust and versatile in use
- for hammering
- Material: impact-resistant plastic, UV-stabilised
- Suitable for: Poly wire, Rope, tape up to 20 mm

New product

NEW



Ref. no.	Colour	MOQ	Pieces / unit		€
442391	black	1 pack	25 / pack	1/25/200	

available from: March 2025

## Offset Ring Insulator

- suitable as a spacer
- Material: Plastic
- with wood thread
- with galvanised support  $\varnothing$  6 mm
- Suitable for: Poly wire, Rope, tape up to 10 mm

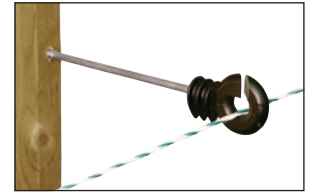

suitable screwdriver 441363/011



Ref. no.	Colour	Support length	MOQ	Pieces / unit		€
441480	black	22 cm	1 pouch	10 / pouch	1/10/300	

## Offset Ring Insulator

- suitable as a spacer
- Material: Plastic
- with wood thread
- with galvanised support  $\varnothing$  6 mm
- Suitable for: Poly wire, rope up to  $\varnothing$  8 mm, tape up to 10 mm

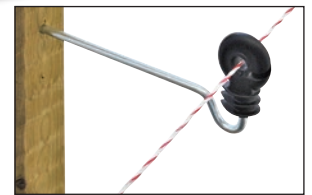

Ref. no.	Colour	Support length	MOQ	Pieces / unit		€
44310	black	22 cm	1 pouch	10 / pouch	1/10/300	
44310/151	black	22 cm	1 pack	15 / pack	1/12	

## Offset Rope Insulator

- suitable as a spacer
- Material: Plastic
- with wood thread
- with short galvanised support  $\varnothing$  6 mm
- Suitable for: Poly wire, rope up to  $\varnothing$  8 mm, tape up to 10 mm



Ref. no.	Colour	Support length	MOQ	Pieces / unit		€
44385	black	22 cm	1 pouch	10 / pouch	1/10/200	

## Offset Tape Insulator

- suitable as a spacer
- Material: Plastic
- with wood thread
- with short galvanised support  $\varnothing$  6 mm
- Suitable for: tape up to 20 mm

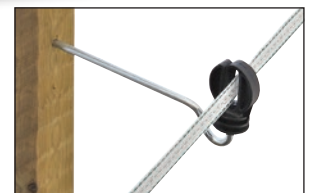

Ref. no.	Colour	Support length	MOQ	Pieces / unit		€
44312	black	22 cm	1 pouch	10 / pouch	1/10/300	
44312/151	black	22 cm	1 pack	15 / pack	1/12	

## Long-Handle Clip Insulator

- suitable as a spacer
- Material: Plastic
- with wood thread
- with galvanised support  $\varnothing$  6 mm
- Suitable for: Poly wire, rope up to  $\varnothing$  6 mm, tape up to 40 mm



suitable screwdriver 441363/011



Ref. no.	Colour	Support length	MOQ	Pieces / unit		€
441395	black	20 cm	1 pouch	10 / pouch	1/10/300	
441395/151	black	20 cm	1 pack	15 / pack	1/12	

## Insulator for double wire mesh fence

- for the stem electrification of a wire mesh fence
- for deterring unwanted intruders such as martens, raccoons, cats, etc.
- easy and tool-free mounting
- made from weather-resistant plastic
- Suitable for: Poly wire, Rope, tape up to 10 mm



Ref. no.	Colour	Length	Width	Height	MOQ	Pieces / unit		€
442389	black	11.5 cm	7 cm	2.5 cm	1 pack	10 / pack	1/35	

## Distance insulator

- for the stem electrification of mesh wire or knotted wire fences
- simply fit onto the round fence posts
- for deterring unwanted intruders such as wolves, wild boar
- made from weather-resistant plastic
- Support length: 25 cm
- Suitable for: Poly wire, Rope, tape up to 10 mm



Ref. no.	Description	Colour	MOQ	Pieces / unit		€
442379	for round posts $\varnothing$ 48 mm	black	1 pack	10 / pack	1/15	
442388	for round posts $\varnothing$ 60 mm	black	1 pack	10 / pack	1/14	



## Stem Eyelet Insulator

- plastic  $\varnothing$  12 mm, support  $\varnothing$  6 mm
- Material: metal, plastic-coated
- nail on with staples 44394 (not included)
- Suitable for: Poly wire, Rope, tape up to 40 mm

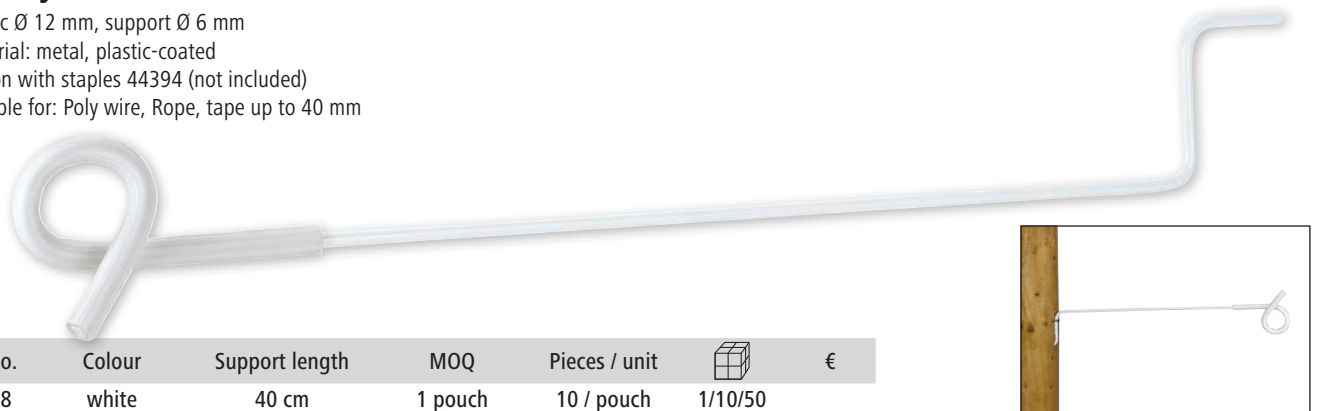

Ref. no.	Colour	Support length	MOQ	Pieces / unit		€
44448	white	40 cm	1 pouch	10 / pouch	1/10/50	

## Offset Pigtail Insulator

- suitable as a spacer
- plastic  $\varnothing$  12 mm, galvanised support  $\varnothing$  7 mm
- with wood thread
- Suitable for: Poly wire, Rope, tape up to 40 mm

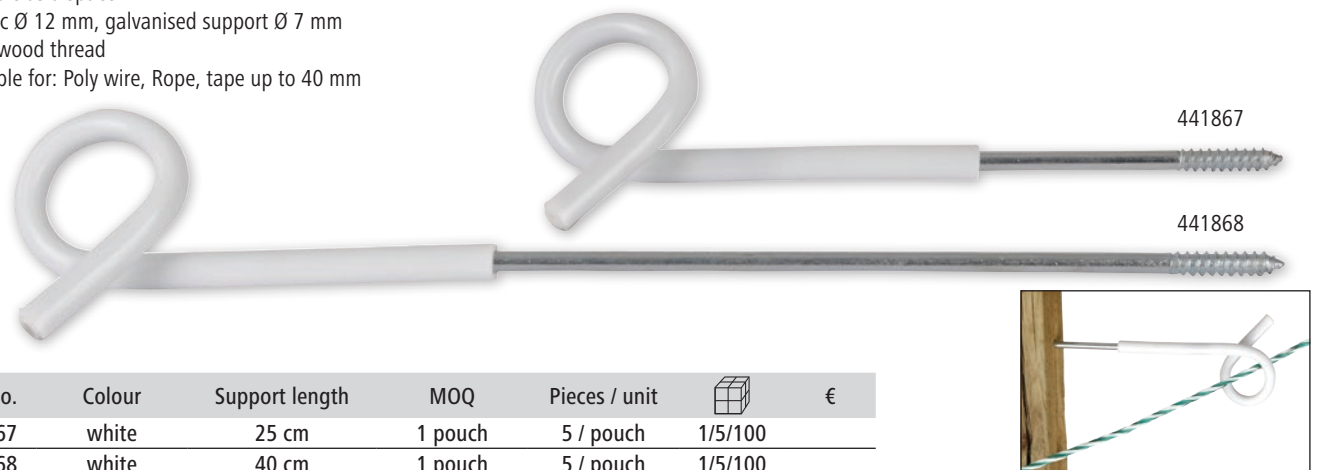

Ref. no.	Colour	Support length	MOQ	Pieces / unit		€
441867	white	25 cm	1 pouch	5 / pouch	1/5/100	
441868	white	40 cm	1 pouch	5 / pouch	1/5/100	





## Gate Insulator X<sup>3</sup> Premium

- new, very robust premium gate insulator
- Stainless steel ring with 3 hanging options
- Material: Plastic
- with wood thread
- with galvanised support Ø 6 mm



industrial design registered  
Stainless Steel Ring



Ref. no.	Colour	MOQ	Pieces / unit		€
446550	blue	1 pouch	10 / pouch	1/10/250	
446550/061	blue	1 pack	6 / pack	1/50	

## Gate / start insulator Premium Vario

- incl. connecting plate made of stainless steel
- with 3 connection options for the gate handle
- ideal as starting insulator, e.g. after a gate
- screw-on fastening

5 year UV stability warranty



professional version larger and made from extremely robust polycarbonate

Stainless steel connecting plate

Ref. no.	Colour	Hole spacing	MOQ	Pieces / unit		€
446545/041	blue	94 mm	1 pack	4 / pack	1/14	

## Gate / start insulator Vario

- incl. connecting plate made of stainless steel
- fiberglass reinforced
- connecting plates each with 3 connection options for gate handles
- ideal as starting insulator, e.g. after a gate
- Material: polyamide glass-fibre reinforced
- screw-on fastening

also ideal for use as a starting insulator  
Stainless steel connecting plate



Ref. no.	Colour	Lochabstand	MOQ	Pieces / unit		€
44237/021	black	70 mm	1 pair	2 / pack	1/50	



suitable wood screws 442610/1001



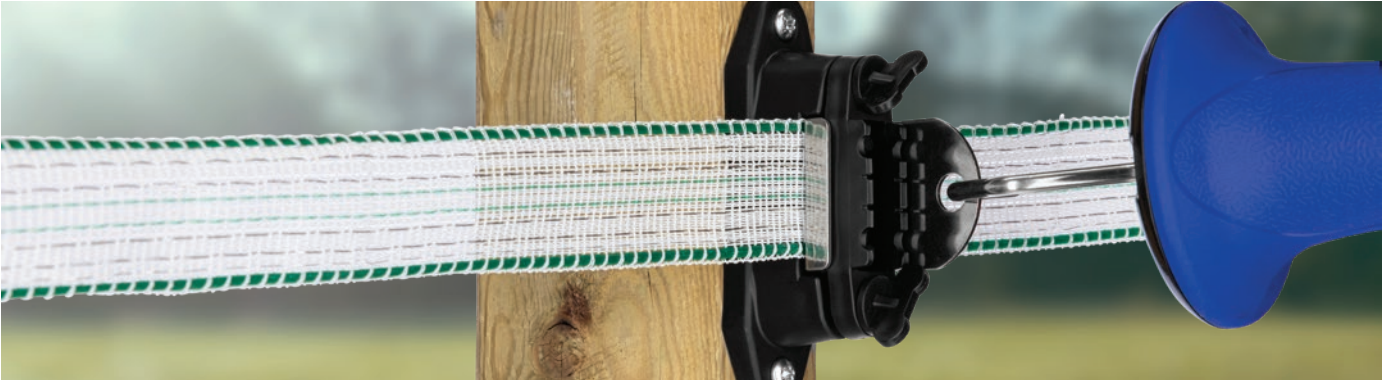



## Combi Insulator Premium

for gates at corners and T-separations

- with robust stainless steel connection plate for mounting gate handles
- enables the simple creation of T-separations on the line post -> the conductor material can continue to run behind the stainless steel plate and does not have to be interrupted
- excellent electrical contact guarantees maximum conductivity between the conductor material and the gate handle
- can also be used ideally as a corner insulator with subsequent gate
- universally applicable for tape, rope and wire
- conductor material can be retensioned very easily
- screw in or nail on

also ideal for use as a starting insulator  
Stainless steel connecting plate

Ref. no.	Colour	MOQ	Pieces / unit		€
446555/031	black	1 pack	3 / pack	1/20	

Ref. no.	Description	Material	MOQ	Pieces / unit		€
443456	Replacement Connection Plate	stainless steel	10 pieces	10 / pouch	1/10/400	





## Gate / start insulator for tapes Premium

- a robust tape insulator with stainless steel connecting plate for gate handle and pasture fence connection
- ideal as starting insulator, e.g. after a gate
- Material: Plastic
- Suitable for: tape up to 40 mm

also ideal for use as a starting insulator

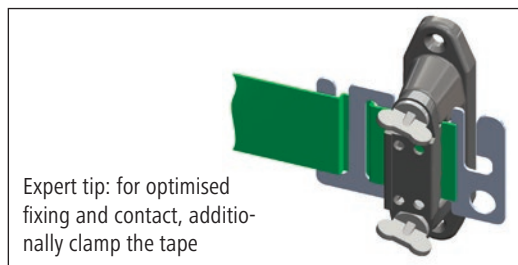
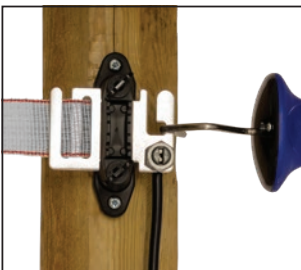
Stainless steel connecting plate



Ref. no.	Colour	MOQ	Pieces / unit		€
44355/041	black	1 pack	4 / pack	1/22	

Ref. no.	Description	Material	MOQ	Pieces / unit		€
443453	Replacement Connection Plate for Start Tape Insulator Premium	stainless steel	10 pieces	10 / pouch	1/10/400	

suitable wood screws 442610/1001





## Gate Insulator X<sup>3</sup>

- new, very robust gate insulator
- galvanised ring with 3 hanging options
- Material: Plastic
- with wood thread
- with galvanised support Ø 6 mm



Geschmacksmuster eingetragen

Ref. no.	Colour	MOQ	Pieces / unit		€
446560	black	1 pouch	10 / pouch	1/10/250	
446560/061	black	1 pack	6 / pack	1/50	

## Gate Insulator

- for attaching gate handles on both sides
- practical and secure
- 360° rotatable hanging loop
- with wood thread
- with galvanised support

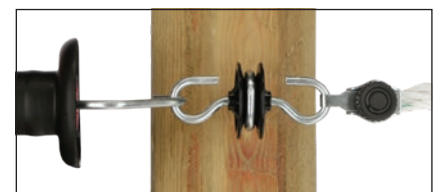

**Important: Not suitable for conductor material with copper wires!**

Ref. no.	Colour	MOQ	Pieces / unit		€
44248	black	1 pouch	10 / pouch	1/10/250	

## Quick rope/poly wire connector

- allows ropes, wires and tapes of up to 10 mm to be connected to gate insulators and handles quickly and easily, resulting in a connection with optimal electrical conductivity
- no tools required



patented



The benefits: No need for tools, easy to create an optimum electrical connection using fixing screws. Also ideally suitable for retightening.

Ref. no.	Material	can be used for	MOQ	Pieces / unit		€
441209/041	galvanised metal	Poly wire, rope up to Ø 8 mm, tape up to 10 mm	1 pack	4 / pack	1	





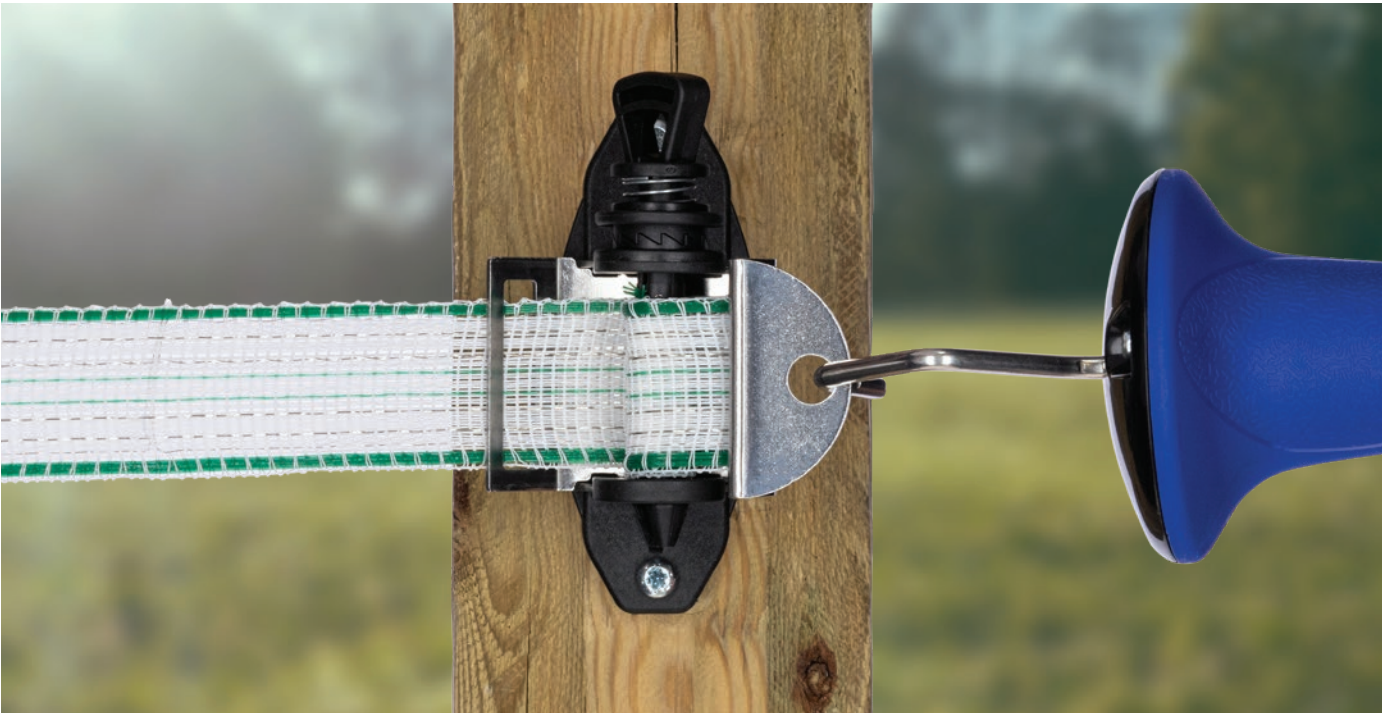

## Gate / Tensioning Isolator TITAN

for gate use and the simultaneous tensioning of the conductor material

- flexibly usable insulator with stainless steel connection plate for mounting gate handles
- ideal initial/final insulator for gates - gate handle is hooked in and directly electrically contacted
- extremely robust thanks to glass fibre-reinforced polyamide
- conductor material can be retensioned very easily and safely by hand using the snap-in function
- screw-on fastening
- Suitable for: tape up to 40 mm



also ideal for use as a starting insulator  
Stainless steel connecting plate

Set includes: 3 x premium insulator TITAN, 3 x stainless steel connecting plate

Ref. no.	Colour	MOQ	Pieces / unit		€
446578/031	black	1 pack	3 / pack	1/25	

Ref. no.	Description	Material	MOQ	Pieces / unit		€
443459	Replacement Connection Plate	stainless steel	10 pieces	10 / pouch	1/10/400	

## Quick rope/poly wire connector

stainless steel

- allows ropes, wires and tapes of up to 10 mm to be connected to gate insulators and handles quickly and easily, resulting in a connection with optimal electrical conductivity
- made from stainless steel, guaranteeing excellent corrosion resistance
- no tools required

patented

stainless steel



The benefits: No need for tools, easy to create an optimum electrical connection using fixing screws. Also ideally suitable for retightening.



Ref. no.	Material	can be used for	MOQ	Pieces / unit		€
441285/041	stainless steel	Poly wire, rope up to Ø 8 mm, tape up to 10 mm	1 pack	4 / pack	1	

# Torgriffe mit Federzugbegrenzung

- mit Federzugbegrenzung, so wird ein Ermüden der Zugkraft der Feder verhindert
- äußerst robuste Qualität
- UV stabilisierter Kunststoff
- hervorragende Isolation

Zugbegrenzung

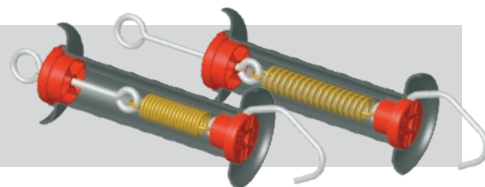

## Torgriff Premium

- sehr robuster und langlebiger Torgriff durch verschraubte Verschlusskappe
- Haken und Öse aus Edelstahl - sorgt für ausgezeichnete Korrosionsbeständigkeit
- spezielle Oberflächenstruktur und sehr große Grifffläche verleiht dem Torgriff einen innovativen Look und angenehme Haptik
- Material: Kunststoff UV-stabilisiert
- mit Federzugbegrenzung



Haken und Öse aus Edelstahl

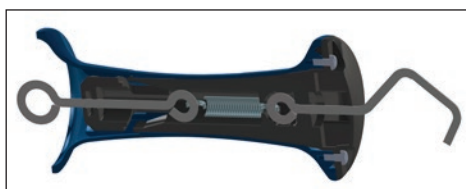

Art. Nr.	Farbe	Stück / VE		€
44991	blau	5 / Beutel	1/5/12	3,99

## Torgriff Soft Grip

- sehr widerstandsfähiger und biegsamer Kunststoff
- bruchfest, auch bei Frost
- Haken und Öse verzinkt
- Material: Kunststoff UV-stabilisiert
- mit Federzugbegrenzung



Art. Nr.	Farbe	BE	Stück / VE		€
44973	schwarz	1 Beutel	5 / Beutel	1/5/100	1,79

## Torgriff

- Einhängenhaken geschlossen
- Ösenhaken und Öse verzinkt
- Material: Kunststoff UV-stabilisiert
- mit Federzugbegrenzung



Art. Nr.	Farbe	BE	Stück / VE		€
44940	schwarz	1 Pack	5 / Pack	1/5/100	2,49

## Torgriff

- Haken und Öse verzinkt
- Material: Kunststoff UV-stabilisiert
- mit Federzugbegrenzung



Top Seller

Art. Nr.	Farbe	BE	Stück / VE		€
44941	schwarz	1 Pack	5 / Pack	1/5/100	2,39

## Torgriff Premium BIG green

- Torgriff aus nachhaltigem biobasiertem Kunststoff - aus 100 % nachwachsenden Rohstoffen
- Holzoptik durch kleine Naturholzspäne im Biokunststoff
- konisch zulaufende Grifffläche für angenehme Haptik
- Verpackung aus 100 % Recyclingpappe
- Haken und Feder verzinkt



Made in Germany

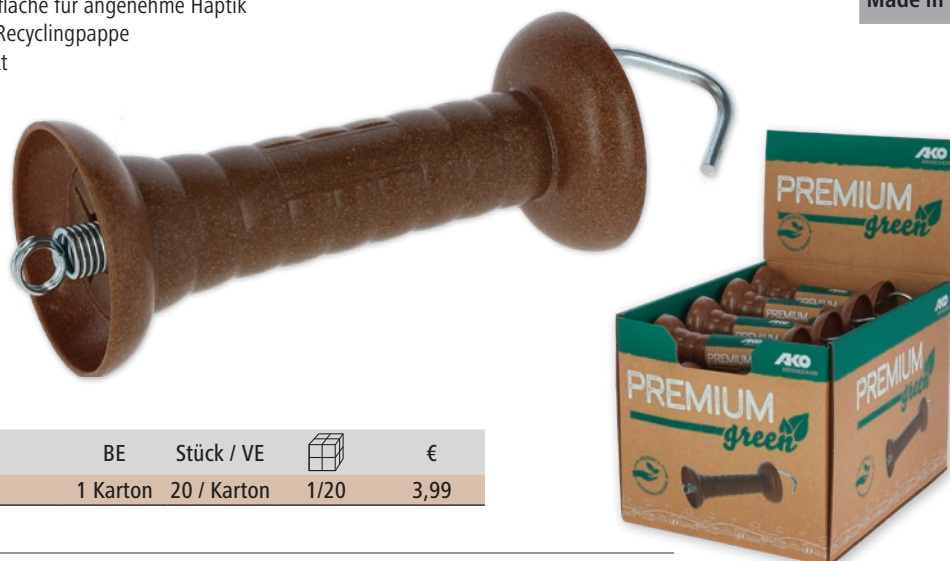

Art. Nr.	Farbe	BE	Stück / VE		€
44977	braun	1 Karton	20 / Karton	1/20	3,99

## Torgriff

- Kunststoff aus Recyclingmaterial bei gleichem Qualitätsstandard
- Haken und Feder verzinkt
- mit einfacher Zugfeder

gefertigt aus recyceltem Kunststoff



Art. Nr.	Farbe	BE	Stück / VE		€
44981-RE	anthrazit	1 Karton	20 / Karton	1/20	1,99

## Torgriff

- Haken und Feder verzinkt
- Material: Kunststoff UV-stabilisiert
- mit einfacher Zugfeder



Art. Nr.	Farbe	BE	Stück / VE		€
44951	schwarz	1 Pack	5 / Pack	1/5/100	1,99
44957	pink	1 Pack	5 / Pack	1/5/100	2,19
44958	neon lila	1 Pack	5 / Pack	1/5/100	2,19
44959	neon grün	1 Pack	5 / Pack	1/5/100	2,19
44960	neon orange	1 Pack	5 / Pack	1/5/100	2,19
44953	gelb	1 Pack	5 / Pack	1/5/100	2,19
44961	petrol	1 Pack	5 / Pack	1/5/100	2,19





## Torgriff Premium mit Litzclip® Bandanschluss

- hochwertiger Torgriff der Premium Klasse in Verbindung mit Litzclip® Bandanschluss
- Haken und Öse aus Edelstahl - sorgt für ausgezeichnete Korrosionsbeständigkeit
- mit Litzclip® Bandanschluss Edelstahl
- Material: Kunststoff UV-stabilisiert
- mit Federzugbegrenzung



Art. Nr.	Farbe	Verbinder	Stück / VE		€
4499120	blau	mit Litzclip® Bandanschluss Edelstahl 20 mm	5 / Beutel	1/5/50	5,99
4499140	blau	mit Litzclip® Bandanschluss Edelstahl 40 mm	5 / Beutel	1/5/12	6,29

## Torgriff mit Litzclip® Bandanschluss

- mit Litzclip® Bandanschluss Edelstahl
- Haken und Öse verzinkt
- Material: Kunststoff UV-stabilisiert
- mit Federzugbegrenzung

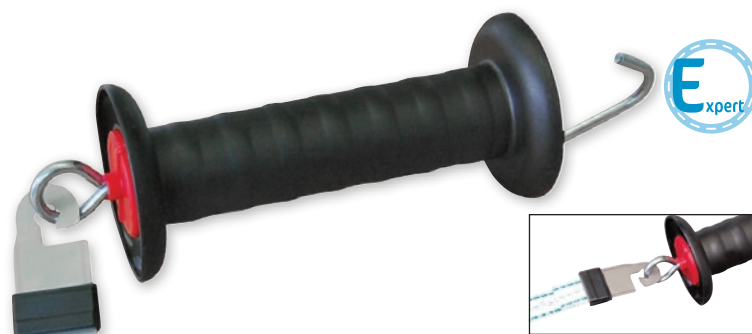

Art. Nr.	Farbe	Verbinder	BE	Stück / VE		€
4494120	schwarz	mit Litzclip® Bandanschluss Edelstahl 20 mm	1 Pack	5 / Pack	1/5/100	3,99
4494140	schwarz	mit Litzclip® Bandanschluss Edelstahl 40 mm	1 Pack	5 / Pack	1/5/100	4,29

## Torgriff mit Litzclip® Verbinder

- mit Litzclip® Seilanschluss Edelstahl
- Haken und Öse verzinkt
- Material: Kunststoff UV-stabilisiert
- mit Federzugbegrenzung



Art. Nr.	Farbe	Verbinder	BE	Stück / VE		€
44969	schwarz	mit Litzclip® Seilanschluss Edelstahl 6 mm	1 Pack	5 / Pack	1/5/100	3,99
44972	schwarz	mit Litzclip® Litzenanschluss Edelstahl 3 mm	1 Pack	5 / Pack	1/5/100	3,99

## Band-Torgriffverbinder Litzclip®

- Die neuen werkzeuglosen Torgriffverbinder für 10, 20 und 40 mm Weidezaunbänder erweitern unser patentiertes, erfolgreiches Litzclip® Sortiment.
- Die Verbinder sind selbsterklärend in ihrer Funktion und lassen sich sehr schnell und einfach an jeden beliebigen Torgriff bzw. Torisolator montieren.



Made in Germany



patentiert

Art. Nr.	Material	verwendbar für	BE	Stück / VE		€
442006/041	Edelstahl	Band bis 20 mm	1 Pack	4 / Pack	1/100	7,99
442007/041	Edelstahl	Band bis 40 mm	1 Pack	4 / Pack	1/100	8,19



## Torgriff Premium mit Seil- und Litzenanschluss

- hochwertiger Torgriff der Premium Klasse in Verbindung mit dem dazu passenden Seil-/Litzen-Schnellverbinder
- Haken und Öse aus Edelstahl - sorgt für ausgezeichnete Korrosionsbeständigkeit
- auch geeignet für Bänder von 10 bis 20 mm
- mit Federzugbegrenzung

Vorteil: Man benötigt kein Werkzeug und kann mittels Fixierschraube mühelos eine optimale elektrische Verbindung herstellen. Auch zum Nachspannen hervorragend geeignet.



Art. Nr.	Farbe	Stück / VE		€
4499185	blau	5 / Beutel	1/5/12	6,29

Art. Nr.	Beschreibung	Material	BE	Stück / VE		€
441285/041	Seil-/Litzen-Schnellverbinder	Edelstahl	1 Pack	4 / Pack	1	8,49

## Torgriff mit Seil- und Litzenanschluss

- neu konzipierter Torgriff inkl. Seil- und Litzenverbinder (bereits am Torgriff montiert)
- auch geeignet für Bänder von 10 bis 20 mm
- Haken und Öse verzinkt
- Material: Kunststoff UV-stabilisiert
- mit Federzugbegrenzung



Vorteil: Man benötigt kein Werkzeug und kann mittels Fixierschraube mühelos eine optimale elektrische Verbindung herstellen. Auch zum Nachspannen hervorragend geeignet.

Art. Nr.	Farbe	BE	Stück / VE		€
44948	schwarz	1 Pack	5 / Pack	1/5/100	3,89



Art. Nr.	Beschreibung	Material	BE	Stück / VE		€
441209/041	Seil-/Litzen-Schnellverbinder	Metall verzinkt	1 Pack	4 / Pack	1	6,49

## Torgriff mit Bandanschluss

- mit Bandanschluss
- Haken und Öse verzinkt
- Material: Kunststoff UV-stabilisiert
- mit Federzugbegrenzung



Achtung: Nicht für Bänder mit Kupferdrähten geeignet!

Art. Nr.	Farbe	Verbinder	BE	Stück / VE		€
44947	schwarz	mit Bandanschluss 40 mm	1 Pack	5 / Pack	1/5/100	3,59

## Fence Clip

- zum Einhängen von Torgriffen bei geöffnetem Tor
- Vermeidung von gefährlichen Stolperfallen sowie Verschmutzung von Leitermaterial und Torgriff
- keine Ableitung mehr durch auf dem Boden liegendes Leitermaterial
- geeignet für Weidezaunbänder bis max. 40 mm Breite, Seile bis 8 mm Durchmesser und Litzen
- Material: Kunststoff

Made in Germany

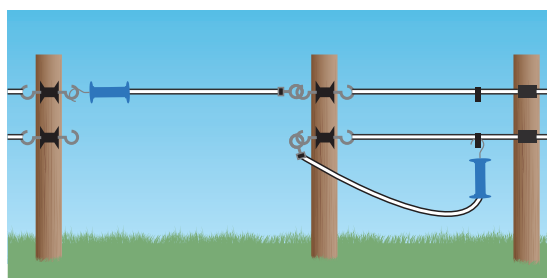

Art. Nr.	BE	Stück / VE		€
442371	1 Pack	8 / Pack	1	4,69



Besonders geeignet für Pferdekoppeln! Durchgehender elektrischer Kontakt!  
integrierte Rückzugsbremse sorgt für kontrolliertes Einziehen des Leitermaterials und beugt Verletzungen und Beschädigungen vor

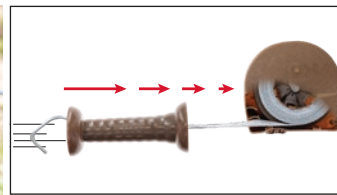

## Tor-Set Premium FLEXIGATE *green*

Innovative Technik, nachhaltiges Material und neuer Look - unser neues flexibles Torsystem für Koppelingänge bis 6 m Breite

- Gehäuse und Torgriff aus nachhaltigem biobasiertem Kunststoff - aus 100 % nachwachsenden Rohstoffen
- Holzoptik durch kleine Naturholzspäne im Biokunststoff
- robustes Gehäuse in kompaktem und modernem Design
- im Lieferumfang enthaltenes Anschlusskabel ermöglicht ideale Kontaktierung und durchgehende Elektrifizierung des Tors
- leichte und schnelle Montage am Pfahl mittels beiliegender Holzschrauben
- hochwertiges Leitermaterial mit unseren bewährten TriCond Drähten sorgt für durchgehend optimale Leitfähigkeit - erhältlich mit 40 mm Breitband oder 6 mm Seil
- Ausrichtung des 40 mm Breitbands lässt sich um 90 Grad im Torgriff drehen und kann damit individuell an Einhängerrichtung des Torgriiffs angepasst werden -> Breitband ist immer stehend und kann somit besser wahrgenommen werden
- ausziehbar bis 6 m Länge
- beidseitige Montage möglich (nach links oder rechts öffnend)



Scannen Sie den QR Code zum Video und entdecken Sie die Vorteile der Flexi-Gates Premium green!

Made in Germany



patentiert

Lieferumfang: 1 x FLEXIGATE green, 1 x Anschlusskabel (40 cm) mit Band- bzw. Seilverbinder zur optionalen Elektrifizierung, 2 x Holzschrauben zur Montage am Pfahl

Art. Nr.	Beschreibung	Farbe		€
442398	mit 40 mm Band	braun	1	49,99
442399	mit 6 mm Seil	braun	1	49,99

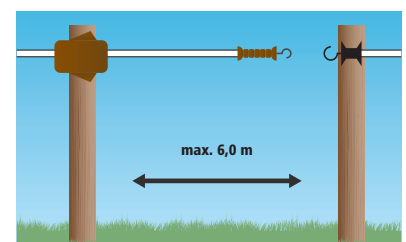



## FlexiGate 19 m

### Das flexible Absperrsystem

Dieses System ermöglicht Ihnen die leichte Unterteilung bzw. Absperrung von einzelnen Koppeln sowie die gezielte Führung Ihrer Tiere (z. B. vom Stall zur Weide).

- Leitermaterial: optimale Stromabgabe durch 9 starke Edelstahlleiter garantieren höchste Hütesicherheit am Tor
- hohe Verarbeitungsqualität
- erhöhte Bruchlast durch starke Monofilfäden
- Befestigung 1: mit 2 beiliegenden Holzschrauben direkt am Holzpfahl oder an einer Wand
- Befestigung 2: mit dem beiliegenden Scharnier

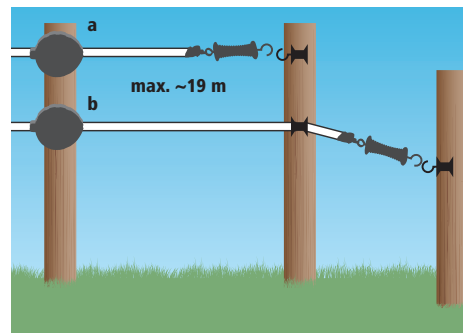

Art. Nr.	Beschreibung	Farbe	max. Durchgangsbreite	BE	Stück / VE		€
441294	mit 20 mm Band	schwarz	19 m	1 Pack	1 / Pack	1/5	64,99

## FlexiGate

### Das flexible Torsystem

Mit Flexigate können Sie Koppelleingänge einfach und bequem unter Strom setzen. Bei jedem Öffnen wird das Leitermaterial von einer Stahlfeder eingerollt.

- Befestigung mit 2 beiliegenden Holzschrauben DIREKT am Holzpfahl
- keine durchhängenden Bänder bzw. Seile
- keine Stolperfalle für Mensch und Tier durch Schleifenbildung
- kein Einklemmen von Mähnen- oder Schweifhaaren
- kein Verdrecken des Leitermaterials
- durchgehender elektrischer Kontakt
- Anschlusskabel nicht im Lieferumfang enthalten



Besonders geeignet für Pferdekoppeln! Durchgehender elektrischer Kontakt!

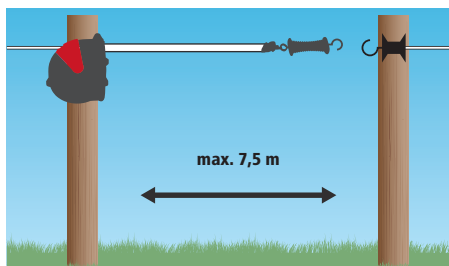

Art. Nr.	Beschreibung	Farbe	Stück / VE		€
441298/011	mit 40 mm Band	schwarz / rot	1 / Pack	1/10	29,99
441299/011	mit 6 mm Seil	schwarz / rot	1 / Pack	1/10	29,99

Art. Nr.	Beschreibung	Farbe	BE	Stück / VE		€
44617/011	Bandanschlusskabel	rot	1 Pack	1 / Pack	1/90	4,99
44627/011	Seilanschlusskabel	rot	1 Pack	1 / Pack	1/90	4,99

## Gate Lock

### Das abschließbare Torsystem

Torgriff in die Anschlussplatte einhängen – Sicherheitsabdeckung zuschieben – Vorhängeschloss zusperren – fertig! Der Torgriff ist somit fest im verschlossenen Sicherheitsgehäuse verankert und nur Befugte erhalten Zugang zur Weide.

Set bestehend aus: 1 x Sicherheitsgehäuse zweiteilig: Wand- bzw. Pfahlbefestigung + Sicherheitsabdeckung, 1 x Torisolator aus robustem Kunststoff und einer Edelstahl-Anschlussplatte, 1 x Torgriff mit Federbegrenzung, 2 x Befestigungsschrauben, 1 x Vorhängeschloss aus Messing mit 2 Schlüsseln



Art. Nr.	Farbe		€
441235	schwarz	1	16,99

## Torfeder-Set

- bis zu 5 Meter dehnbar

Set bestehend aus: 1 x Torgriff mit Haken,  
1 x Spezialfeder verzinkt, 2 x Isolator

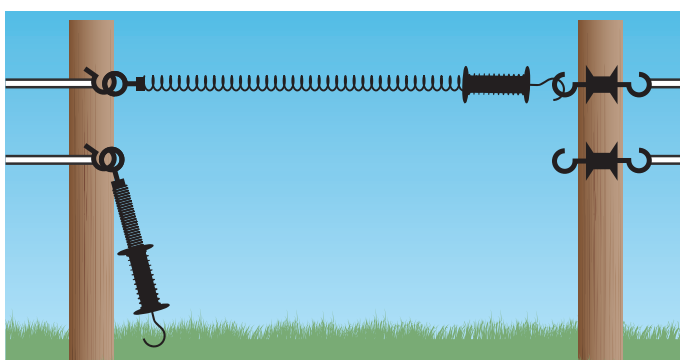
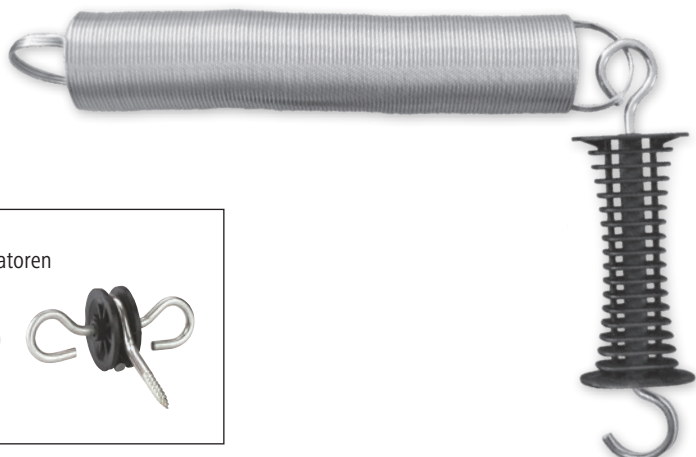

Nicht geeignet für Pferdezäune!

Art. Nr.	Beschreibung	Farbe	Dehnbarkeit	Stück / VE		€
44945/011	inkl. 2 Torisolatoren	schwarz	5 m	1 / Pack	1/12	7,99
44945	inkl. Ring- und Torisolator	schwarz	5 m		1/15	6,99

Art. Nr.	Beschreibung	Material	BE	Stück / VE		€
44246	Ersatzfeder für Torfeder-Set	Metall verzinkt			1/20	5,79
441209/041	Seil-/Litzen-Schnellverbinder	Metall verzinkt	1 Pack	4 / Pack	1	6,49

## Torsystem E-Line

Das originale E-Line System „Made in EU“ für höchste Qualitätsansprüche

- mit stromführendem Elastikseil
- sehr praktische und handliche Elektroantüre für Zaunöffnungen
- kein Einklemmen von Mähnen- oder Schweifhaaren
- mit Edelstahlhaken
- korrekte Montage des Torsystems durch Verwendung von 3 Torpfählen
- auf ca. doppelte Länge ausziehbar

Set bestehend aus: 1 x Ø 7 mm Elastik-Elektrorseil (3 Jahre Garantie) mit 4 x 0,25 mm Edelstahlleiter, mit Verbindungshaken, 1 x robuster Torgriff, 1 x Ringsisolator, 1 x Torisolator

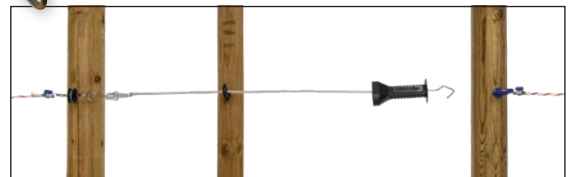

Besonders geeignet für Pferdekoppeln!

Art. Nr.	Dehnbarkeit	BE	Stück / VE		€
44255/011	3 - 6 m	1 Pack	1 / Pack	1/16	17,49
442551/011	4,5 - 9 m	1 Pack	1 / Pack	1/16	19,99

## Torsystem Eco

Preisgünstiges Flexiseil-Torgriffset

- mit stromführendem Elastikseil
- auf ca. doppelte Länge ausziehbar
- kein Einklemmen von Mähnen- oder Schweifhaaren

Set bestehend aus: 1 x Torgriff, 1 x stromführendes 7 mm Elastikseil mit 3 x 0,30 mm Edelstahlleiter, 2 x Seilverbinder, 1 x Ringsisolator, 2 x Torisolator



Art. Nr.	Farbe	Dehnbarkeit		€
4418651	weiß / schwarz	3 - 6 m	1/15	12,99
4418661	weiß / schwarz	4,5 - 9 m	1/15	17,99

Art. Nr.	Beschreibung	Länge		€
441890	Gummi Elektroseil	25 m	1/12	31,99
441891	Gummi Elektroseil	50 m	1/6	58,99











## Elektro-Viehschranke Electro Gate

- ist mit unseren Weidezaungeräten zu betreiben und kann leicht in bestehende Zaunanlagen eingesetzt werden
- die flexiblen Glasfaserstäbe sind mit elektrisch leitfähigem Gummi überzogen
- isolierte Handgriffe für Fußgänger
- das physikalische Gesetz des Faradayschen Käfigs schützt den Fahrer vor elektrischen Schlägen
- öffnet sich in beide Richtungen und schließt selbständig
- feststellbar im geöffneten Zustand

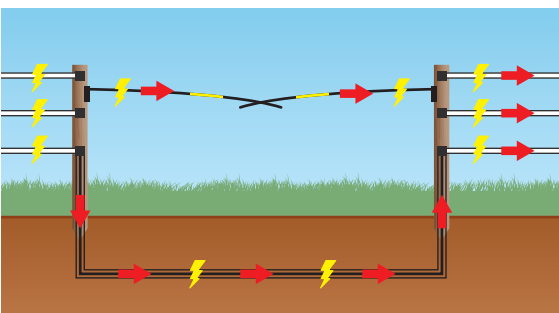
44283: 1 x Stab, 1 x Scharnier, 1 x isoliertes Erdkabel

Set bestehend aus: 2 x Stab, 2 x Scharnier, 1 x isoliertes Erdkabel



Art. Nr.	Farbe	max. Durchgangsbreite		€	
441287	schwarz	6 m	1	299,00	
44282	schwarz	5 m	1	259,00	
44281	schwarz	3,6 m	1	229,00	
44283	schwarz	1,2 m	1	114,00	

Art. Nr.	Beschreibung	Farbe	Material	Länge		€
441288	Ersatzstab Electro Gate	schwarz	Fiberglas	3 m	1	115,00
44285	Ersatzstab Electro Gate	schwarz	Fiberglas	2,5 m	1/50	99,99
44284	Ersatzstab Electro Gate	schwarz	Fiberglas	1,8 m	1/50	89,99
44286	Ersatzscharnier Electro Gate				1/125	88,99



## Pasture Gate adjustable

- stable galvanised steel pasture gate

Included in delivery: 1 x pasture gate, 2 x hinges, 1 x locking facility, 6 x wood screws (12 x 80 mm)



The hinge installation set can be compensated by adjusting the threaded hinge bolts.



Can be extended with an adjustable set screw



Closing option available (without lock)  
• optional padlock for locking

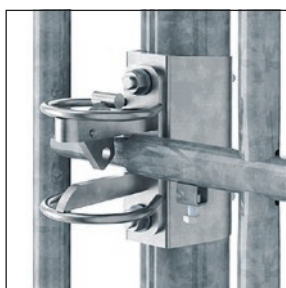
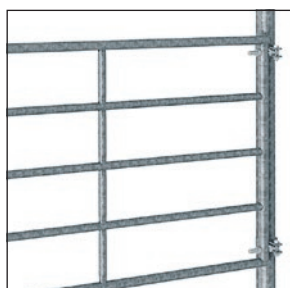
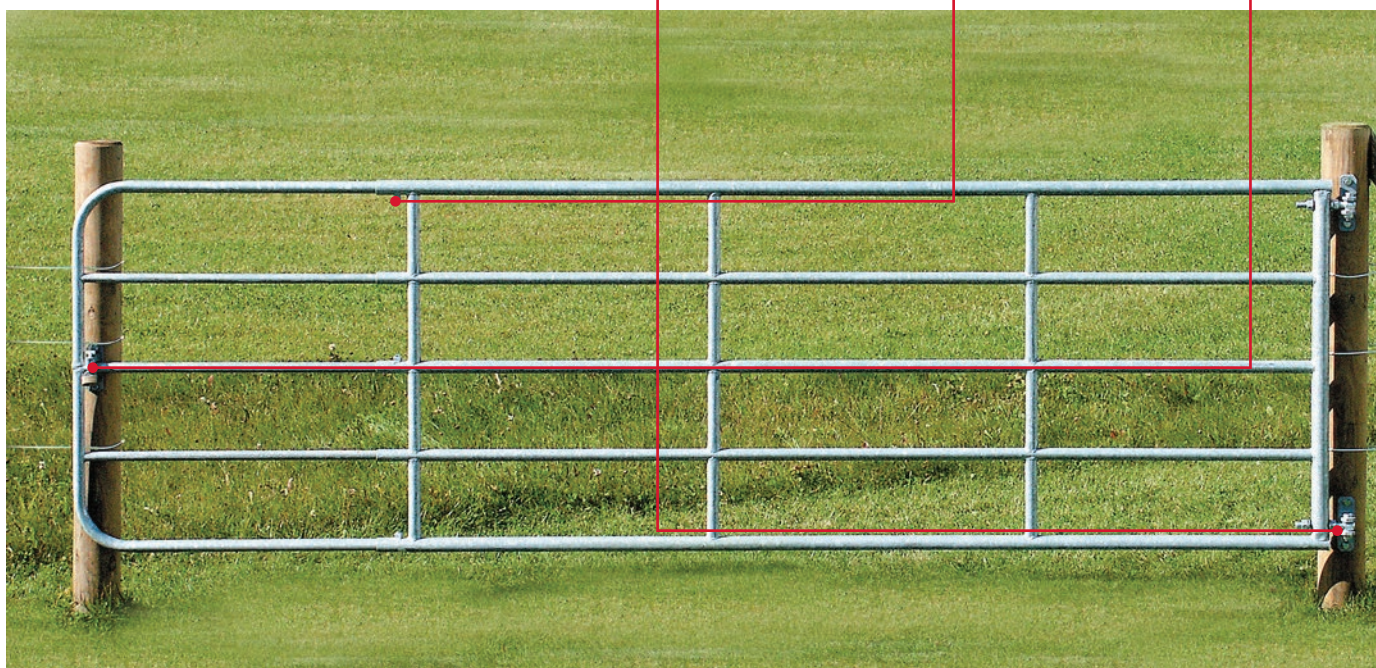

The hinge installation set can be compensated by adjusting the threaded hinge bolts (freely height-adjustable).

Closing option available (without lock)



442578



442579

Ref. no.	Description	Adjustability	Height	Material		€	
44893	Pasture Gate adjustable	1 - 1.7 m	110 cm	steel, hot-dip galvanised	1		
44892	Pasture Gate adjustable	2 - 3 m	110 cm	steel, hot-dip galvanised	1		
44891	Pasture Gate adjustable	3 - 4 m	110 cm	steel, hot-dip galvanised	1		
44895	Pasture Gate adjustable	4 - 5 m	110 cm	steel, hot-dip galvanised	1		
442557	Pasture Gate adjustable	5 - 6 m	110 cm	steel, hot-dip galvanised	1		

Ref. no.	Description	Material	Length	Ø		€	
442577	Gate Post for Pasture Gate with plastic cap	hot-dip galvanised metal	2 m	88 mm	1		
442578	Lock Catch for Gate Post	hot-dip galvanised metal			1		
442579	Hinge pin bracket (in pairs) for gate post	hot-dip galvanised metal			1		
442940	Locking Bar for Pasture Gate	hot-dip galvanised metal			1		

Please note separate freight costs.  
available from: March 2025





## Pasture Gate adjustable

- stable galvanised steel pasture gate

442904:

- NEW: our tried-and-tested, 90-cm-high adjustable pasture gates are also available as a compact version with a flexible width from 1.0 - 1.7 m

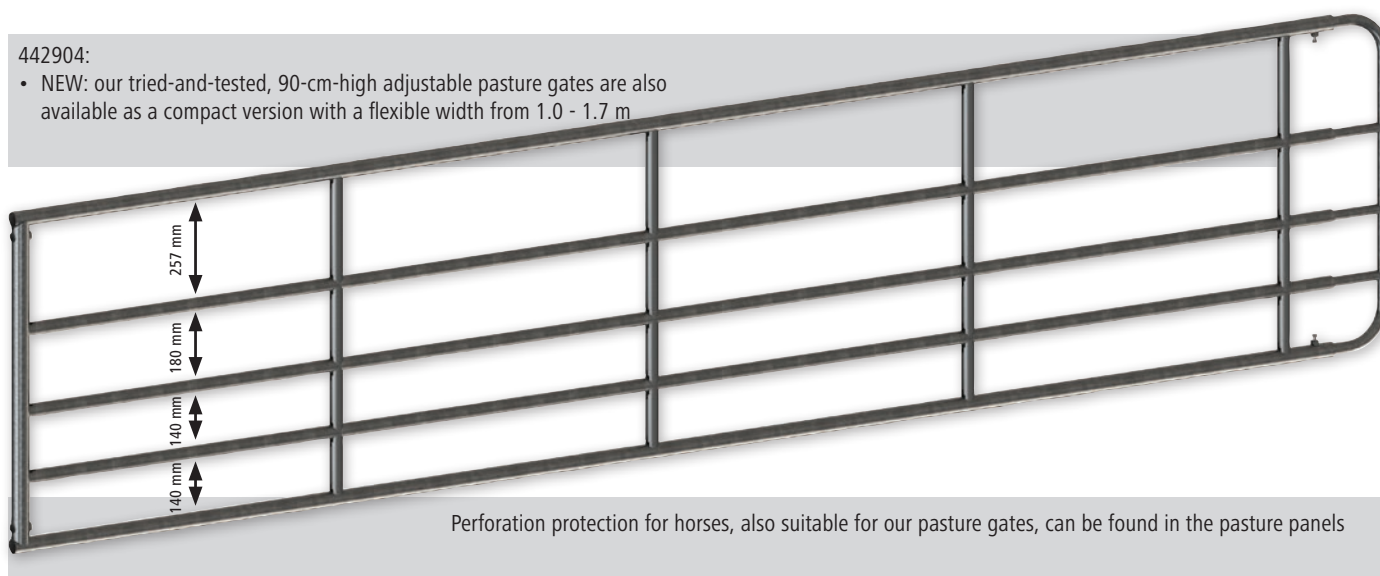









Included in delivery: 1 x pasture gate, 2 x hinges, 1 x locking facility, 6 x wood screws (12 x 80 mm)

Please note separate freight costs.  
available from: March 2025

442940



Ref. no.	Description	Adjustability	Height	Material	 	€	 <b>NEW</b>
442904	Pasture Gate adjustable	1 - 1.7 m	90 cm	steel, hot-dip galvanised	1 40		
442900	Pasture Gate adjustable	2 - 3 m	90 cm	steel, hot-dip galvanised	1 50		
442901	Pasture Gate adjustable	3 - 4 m	90 cm	steel, hot-dip galvanised	1 23		
442902	Pasture Gate adjustable	4 - 5 m	90 cm	steel, hot-dip galvanised	1 23		

Ref. no.	Description	Material	Length	Ø		€	
442577	Gate Post for Pasture Gate with plastic cap	hot-dip galvanised metal	2 m	88 mm	1		
442578	Lock Catch for Gate Post	hot-dip galvanised metal			1		
442579	Hinge pin bracket (in pairs) for gate post	hot-dip galvanised metal			1		
442940	Locking Bar for Pasture Gate	hot-dip galvanised metal			1		





## Pasture gate adjustable for horse owners

Robust and durable safety for your horses at gates and passageways.

- especially robust design that complies with the relevant horse care directives with its product dimensions
- clear widths between the tubes are configured in such a way that horses cannot become dangerously trapped in the gate and then no longer be able to free themselves
- thanks to the protective distance bar supplied, horses cannot get into the dangerously narrow space between the gate and suspension or jump up and injure themselves
- stable, hot-dip galvanised steel pasture gate



Complies with the applicable directives for horse husbandry

Included in delivery: 1 x pasture gate, 1 x distance protection bar, 2 x hinges, 1 x locking facility, 6 x wood screws (12 x 80 mm)

New product

NEW

Ref. no.	Description	Adjustability	Height	Material		€
442910	Pasture gate adjustable for horse owners	1 - 1.7 m	90 cm	steel, hot-dip galvanised	1 40	

available from: March 2025

## Pasture Gate not adjustable

- stable galvanised steel pasture gate
- 4 different models with fixed widths (min. 3 m – max. 5 m)

Included in delivery: 1 x pasture gate, 2 x hinges, 1 x locking facility, 6 x wood screws (12 x 80 mm)

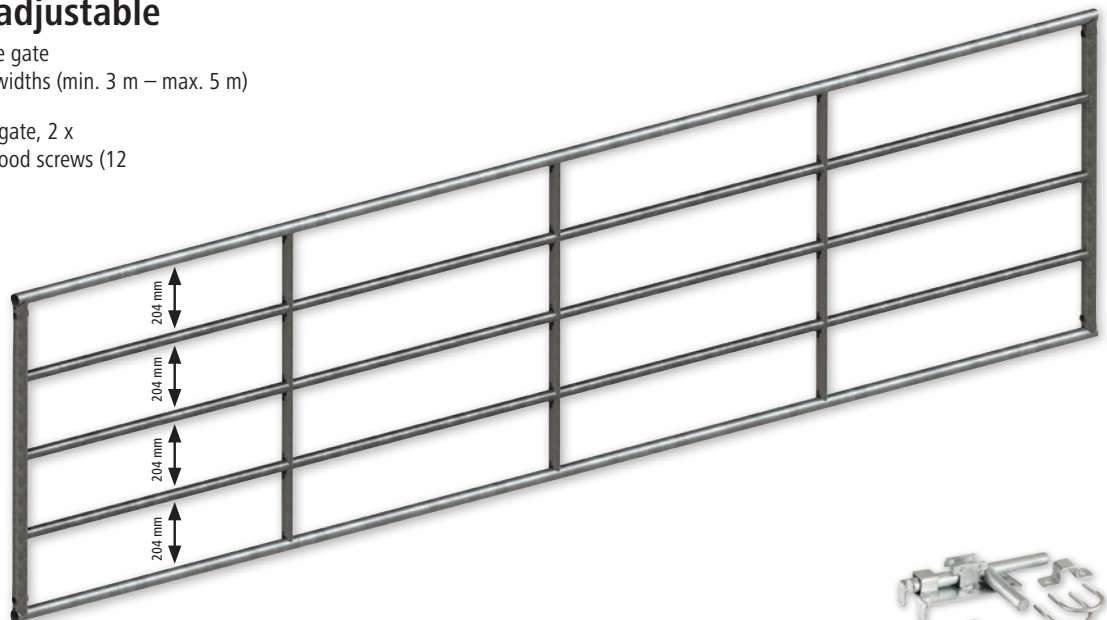

Please note separate freight costs.

442940



Ref. no.	Description	Length	Height	Material		€
442920	Pasture Gate not adjustable	3 m	1 m	steel, hot-dip galvanised	1 23	
442921	Pasture Gate not adjustable	3.5 m	1 m	steel, hot-dip galvanised	1 23	
442922	Pasture Gate not adjustable	4 m	1 m	steel, hot-dip galvanised	1 23	
442924	Pasture Gate not adjustable	5 m	1 m	steel, hot-dip galvanised	1 23	

Ref. no.	Description		€
442940	Locking Bar for Pasture Gate	1	



## Mounting Set for Pasture Gates

- for easy mounting of your pasture gate to the post
- Material: Hot galvanised metal

Set consisting of: 2 x hinges, 1 x closure option (442558), 6 x wood screws

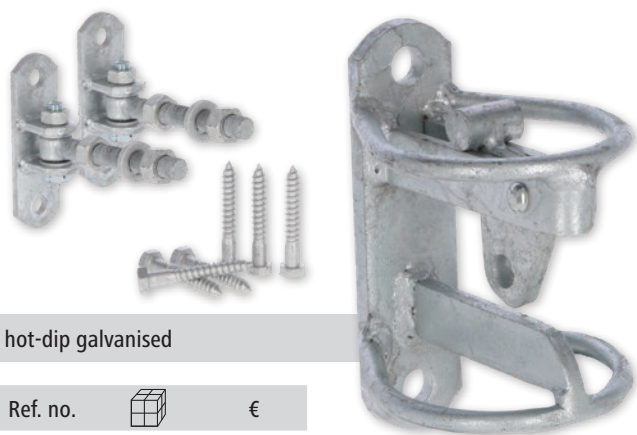

hot-dip galvanised

Ref. no.		€
44890	1	

## Closing Option for Pasture Gate Mounting Set

- enables you to lock your pasture gate via the brass padlock
- Padlock not included
- Material: hot-dip galvanised metal



hot-dip galvanised

Ref. no.		€
442558	1	

## Swing-Through Lock for Fence Gates

- the swing-through lock allows the gate to be opened in both directions
- the lock is fitted to the post and gate using the screws supplied
- can be used on all fence gates
- Material: metal



Ref. no.	Colour		€
441025	black	1/6	

## Cover for Pasture Gates

- enables the assembly or safe connection of double-leaf gates
- secure locking mechanism with latching function, optionally lockable with padlock (not included)
- suitable for all rigid and extendable pasture gates
- Material: hot-dip galvanised metal

Recommended accessories: Locking Spike for Pasture Gates (442572)



Ref. no.		€
442571	1	

## Stabiliser for Adjustable Pasture Gates

- Solid Rubber Wheel Ø 200 mm
- all steel parts are hot dip galvanised
- can be height-adjusted



Ref. no.		€
442559	1	

## Locking Spike for Pasture Gates

- enables open pasture gates to be fixed in any position
- ideal when setting up double-leaf pasture gates to lock the other half of the gate when one leaf is opened - recommended accessory: Cover for Pasture Gate (442571)
- suitable for all rigid and extendable pasture gates
- very simple and quick assembly, all screws and brackets are included
- height can be flexibly adjusted by means of slotted holes, so that pasture gates with larger floor distances can also be fixed in place
- Material: hot-dip galvanised metal



Ref. no.		€
442572	1	





## Electrics Kit for Fence Gates

- kit for additional electrification of your fencing system around fence gates
- fence gate can continue to be opened by hand

441224 Set consisting of: 6 x ring clamp, 6 x ring insulator with short support and metric thread, 1 x rope/tape coupling, 14 m rope Ø 6 mm (Top Line Plus)

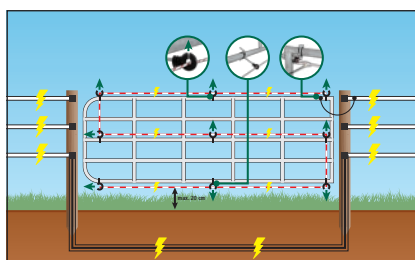
442941 Set consisting of: 9 x ring clamp, 9 x ring insulator with 80 mm metric thread, 1 x rope/tape coupling, 20 m rope Ø 6 mm (Top Line Plus)



Ref. no.	Description	Pieces / unit		€
441224	Set of 6	1 / pack	1/16	
442941	Set of 9 especially for wolf defence		1	



## Sheep Hurdle

- practical connecting system for easy and tool-free installation of hoardings
- suitable for the creation of pre-gathering spaces, pens, individual and group boxes or stall dividers
- 7 cross tubes with increasing spacing from bottom to top, tube diameter: 25.0 or 21.3 mm

442603: door with lock latch and reinforced frame, width of 57 cm

442604: door with lock latch and reinforced frame, width of 57 cm

442611 : with two centrally located lamb slips with adjustable slip width (17.5 cm / 24.5 cm)



Extra strong connecting plates (5 mm)

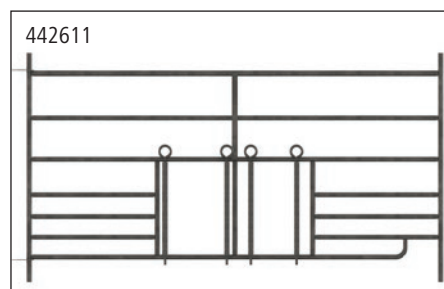
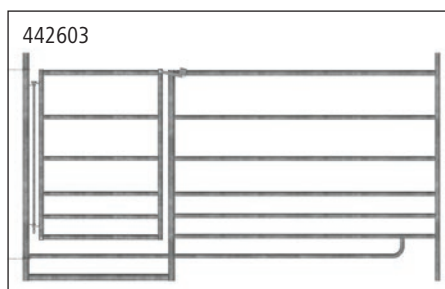
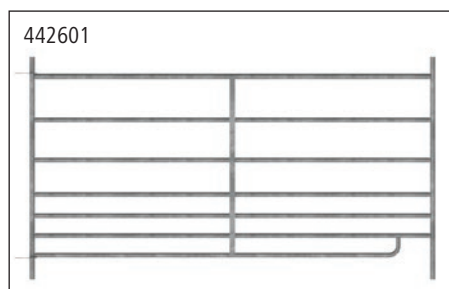

Please note separate freight costs.

Ref. no.	Description	Material	Width	Height			€	
442600	Sheep Hurdle	steel, hot-dip galvanised	137 cm	92 cm	1	80		
442601	Sheep Hurdle	steel, hot-dip galvanised	183 cm	92 cm	1	80		
442602	Sheep Hurdle	steel, hot-dip galvanised	275 cm	92 cm	1	80		
442603	Sheep Hurdle with door	steel, hot-dip galvanised	183 cm	92 cm	1	68		
442604	Sheep Hurdle with door	steel, hot-dip galvanised	275 cm	92 cm	1	60		
442611	Sheep Hurdle with 2 lamb slips	steel, hot-dip galvanised	183 cm	92 cm	1	60		

Ref. no.	Description	Material	Length	Width	Height	Ø		€
442606	Spare Strut for connecting hoardings with shafts	steel, hot-dip galvanised			92 cm		1	
442607	Bucket Holder	steel, hot-dip galvanised				30 cm	1	
32702	Double Hay Rack	steel, hot-dip galvanised	61.5 cm	50 cm	48 cm		1	
32704	Double Hay Rack	steel, hot-dip galvanised	62.5 cm	51 cm	48 cm		1	
442612	Connecting Rod for Plug Trays	steel, hot-dip galvanised			95 cm		1/10	
442617	Replacement hand clasp for modular hoarding with door (442603)	steel, hot-dip galvanised	12 cm	6 cm	4.5 cm		1/20	
442618	Spare shaft for modular hoarding with 2 lamb slips	steel, hot-dip galvanised	50 cm				1/20	





## Pasture Shelter Complete Set for Sheep and Goats

- for setting up a mobile shelter or grazing tent for sheep and goats (protection against rain, wind and sun)
- Shelter dimensions: 2.75 m x 2.75 m
- tool-free and easy assembly using plug connections and wing nuts
- extremely durable and UV-stable truck tarpaulin, stitched at the corners
- the tarpaulin is fastened to the roof structure using leather straps or using the supplied cable ties with the portable pens

442614 Set consisting of:



- 1 x roof structure including screws and tarpaulin with eyelets and leather straps (442615)
- 3 x portable pen, 275 x 92 cm, galvanised metal (442602)
- 1 x portable pen with door, 275 x 92 cm, galvanised metal (442604)
- 4 x ground anchor for portable pen shelter, 60 cm, galvanised metal (442616)

(442616)

442615 Set consisting of:

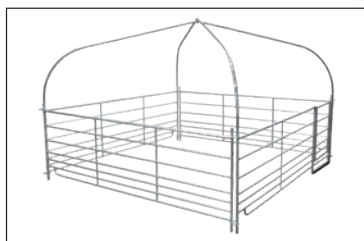
- 1 x roof structure including screws and tarpaulin with eyelets and leather straps (442615)



Ref. no.	Description		€
442614	Portable pen set incl. door and matching canopy with tarpaulin and poles	1	
442615	Roofing (tarpaulin and poles) without portable pens	1	

Ref. no.	Description	Material	Length	Ø	MOQ	Pieces / unit		€
442616	Ground Anchor for Portable Pen Shelter	galvanised metal	60 cm	10 mm	1 pack	4 / pack	1/10	

## Pasture Panel

- perfect for erecting mobile and flexible fencing as well as temporary horse boxes
- also commonly used to fence off riding and training areas
- also suitable for constructing trap systems and gangways
- height of upper tube 1.6 m
- safety mounting bracket prevents animals from being injured. When landing on the panel, the animal does not fall between two panels if it slips
- made from flat oval pipe 50 x 30 mm
- clear distance between tubes 20 cm
- rapid chain fastening makes it quicker and easier to connect several panels
- very stable at light loads
- curved feet ensure excellent stability

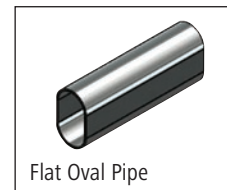

Rapid chain fastening, hot-dip galvanised

Safety mounting bracket

curved feet ensure excellent stability

Please note separate freight costs.

Ref. no.	Description	Material	Length	Height			€	
442591	Pasture Panel without gate	steel, hot-dip galvanised	240 cm	170 cm	1	35		
442592	Pasture Panel without gate	steel, hot-dip galvanised	300 cm	170 cm	1	36		
442593	Pasture Panel without gate	steel, hot-dip galvanised	360 cm	170 cm	1	18		

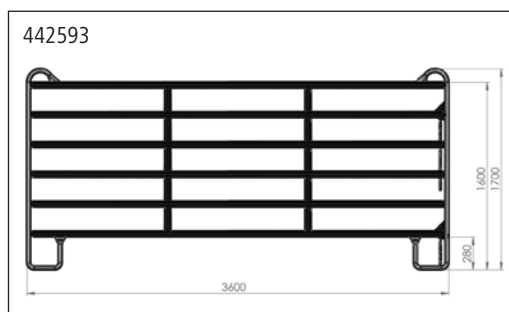
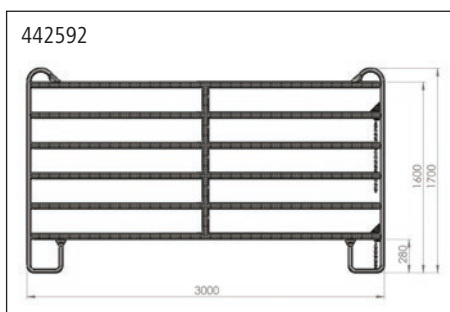
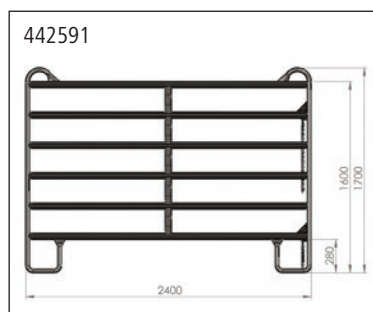

## Wall/floor Bracket for Pasture Panels

- for fixing pasture panels or modular hoardings to the wall or ground
- by omitting the screw close to the wall, panels can also be fixed at a slight angle to compensate for small slopes or inclines in the terrain
- Material: hot-dip galvanised metal



Ref. no.		€
442573	1/10	

## Connector for Pasture Panels

- ideal for connecting two pasture panels (flat oval tubes)
- we always recommend the use of two connectors for a secure connection of two pasture panels
- also enables the connection of pasture panels across corners
- suitable for all pasture panels with/without gate
- Material: hot-dip galvanised metal



Ref. no.		€
442574	1/20	



## Fence Panel with Gate

- allows an opening to be created in the fencing
- gate width 1 m
- lock for opening and closing the fenced area

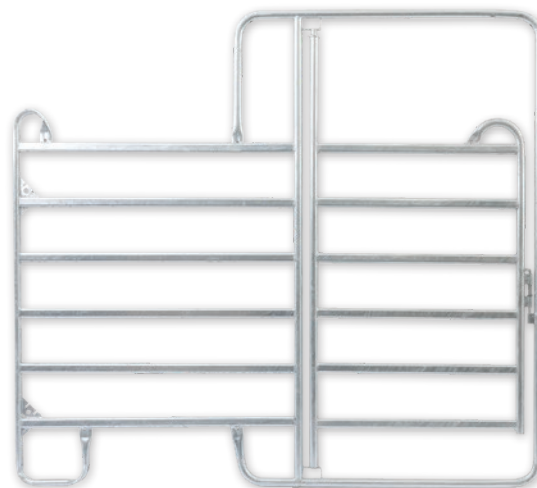

Example for mounting

Locking bolt

Please note separate freight costs.

Ref. no.	Description	Material	Length	Height			€	
442594	Fence Panel with Gate	steel, hot-dip galvanised	240 cm	220 cm	1	18		
442595	Fence Panel with Gate	steel, hot-dip galvanised	300 cm	220 cm	1	18		
442596	Fence Panel with Gate	steel, hot-dip galvanised	360 cm	220 cm	1	18		

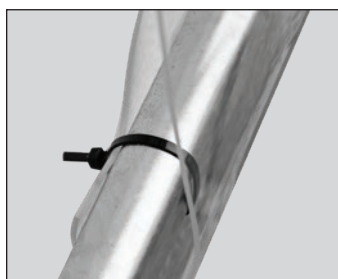

## Panel cover penetration protection

New product

NEW

- innovative and robust solution as step protection for pasture gates and panels: eliminates the risk of horses getting their heads or legs caught between the steel tubes and getting stuck
- ideal for mobile stables, paddocks and partitions, exclusively for outdoor use in agriculture or industry
- compatible with all commercially available pasture gates and panels
- suitable for various sizes and breeds of horse
- by combining several panel covers, any size of pasture gate or panel can be covered, size customisable
- easy and problem-free to install thanks to low product weight and delivery including necessary mounting parts and pre-drilled holes
- Protection against wind and draughts for horse and bedding or feed without darkening the area behind it
- Material: PVC, UV-stabilised

can be used for panels and pasture gates



Included in delivery: 1 x PVC tarpaulin 1.5 m x 1 m x 2.5 mm, Screws, washers, nuts and cable ties, assembly instructions

Ref. no.	Colour	Length	Width	Material thickness			€
442628	transparent	1.5 m	1 m	2.5 mm	1	54	



Three point attachment  
(with safety guard)



Circumferential roof edge protection



2 square tubular supports for even  
more stability

When used with feeds that may attack the galvanised surface (e.g. silage), apply a protective coat of paint first.

## Four-sided manger for palisade feeding grid



- universal hay rack for horses and cattle
- suitable for round and rectangular bales up to 1.8 m in length or diameter
- extremely stable design, high material thickness, 2 square pipe beams
- 2 sides can easily be opened for filling
- height-adjustable runners (adjustable to the animal's size)
- three-point attachment
- very little food loss
- supplied as a construction kit including circumferential roof edge protection, three-point safety clip
- Internal trough dimensions: approx. 2.0 x 2.0 m
- Material: hot-dip galvanised metal



Please note separate freight costs.

Ref. no.	Length	Width	Height	Feed areas			€	
291255	212 cm	212 cm	250 cm	12	1	6		

## Square Hay Rack for Horses with Safety Feeding Barrier



- Feed rack for horses with 12 feeding places
- suitable for round and rectangular bales up to 1.8 m in length or diameter
- extremely stable design, high material thickness, 2 square pipe beams
- 2 sides can easily be opened for filling
- height-adjustable runners (adjustable to the animal's size)
- three-point attachment
- very little food loss
- supplied as a construction kit including circumferential roof edge protection, three-point safety clip
- Internal trough dimensions: approx. 2.0 x 2.0 m
- Material: hot-dip galvanised metal



Please note separate freight costs.

Ref. no.	Length	Width	Height	Feed areas			€	
291256	212 cm	212 cm	250 cm	12	1	6		

## Slow Feeding Net

The net is placed over the food/bales so that the animals eat more slowly and thoroughly, helping to improve their digestion.

- reduced dust formation • appropriate feeding • little food is wasted
- with rubber cord • Material: Polypropylene

art. 291344 galvanised frame

- for easier fastening of the slow feeding net • convenient and quick to fold up and down

Ref. no.	Colour	Length	Width	Mesh size		€
291260	green	3.6 m	2.4 m	45 x 45 mm	1/6	
291261	green	3.6 m	2.4 m	100 x 100 mm	1/10	
291262	green	2.8 m	2.8 m	45 x 45 mm	1/6	
291263	green	2.8 m	2.8 m	100 x 100 mm	1/12	





Ref. no.	Description	Material	Length	Width	suitable for		€
291344	Frame for Slow Feeding Net	galvanised metal	181 cm	181 cm	291255, 291256, 291289	1	



## Standard four-sided rack with palisade feeding grid

- suitable for round and rectangular bales up to 1.8 m in length or diameter
- Ground tub reinforced with 2 additional pipes
- 2 sides can easily be opened for filling
- newly developed three-point linkage with foldable mountings for the tractor drawbar
- very little food loss
- Internal trough dimensions: approx. 1.9 x 1.9 m
- Supplied as a construction kit including circumferential roof edge protection
- height-adjustable runners (adjustable to the animals' size)
- Material: hot-dip galvanised metal





Ref. no.	Length	Width	Height	Feed areas			€
291289	230 cm	230 cm	250 cm	12	1	6	

Please note separate freight costs.

## Square hay rack Hobby

- suitable for round and rectangular bales up to 1.4 m in length or diameter
- Ground tub reinforced with 2 additional pipes
- 2 sides can easily be opened for filling
- newly developed three-point linkage with foldable mountings for the tractor drawbar
- very little food loss
- Internal trough dimensions: approx. 1.45 x 1.45 m
- height-adjustable runners (adjustable to the animal's size)
- Supplied as a construction kit including circumferential roof edge protection
- Material: hot-dip galvanised metal



Ref. no.	Length	Width	Height	Feed areas			€
291300	150 cm	150 cm	240 cm	8	1	6	

Please note separate freight costs.

## Square Hay Rack Standard with Self-Closing Feeding Grate for Hornless Cattle

- suitable for round and rectangular bales up to 1.8 m in length or diameter
- 1 x square tubular support
- 2 sides can easily be opened for filling
- three-point attachment
- very little food loss
- supplied as a construction kit including circumferential roof edge protection, three-point safety clip
- Internal trough dimensions: approx. 1.9 x 1.9 m
- Material: hot-dip galvanised metal



Ref. no.	Length	Width	Height	Feed areas			€
291294	230 cm	230 cm	250 cm	12	1	6	

Ref. no.	Description	Material			€
291299	Individual Self-Closing Grate	hot-dip galvanised metal	1	6	

Please note separate freight costs.





## Round rack with 8 feeding slots

for loose feed or small high-pressure bales

- palisade feeding grid
- supplied as a kit
- 4-part, can be transported in an estate car
- outdoors or in play pens, the segments can also be used to set up wall or corner mangers
- no three-point hitch
- Material: hot-dip galvanised metal

Please note separate freight costs.

Technical data	291257
Height	116 cm
Exterior diameter	150 cm
Interior diameter	132.5 cm
Feed areas	8

Ref. no.			€	
291257	1	5		



## Round rack with 12 feeding slots

for normal and round bales

- palisade feeding grid
- 3-piece
- three-point attachment
- supplied as a kit
- Material: hot-dip galvanised metal

Please note separate freight costs.

Technical data	291258
Height	116 cm
Exterior diameter	236 cm
Interior diameter	219 cm
Feed areas	12

Ref. no.			€	
291258	1	5		



## Fodder rack

- for sheep, goats, deer or calves
- for small bales and loose hay
- with concentrated feed trough
- Material: hot-dip galvanised metal
- Comes disassembled







291347 and 291346 available from July 2025



New product

NEW





Ref. no.	Description	Length	Width	Height	Rod distance			€	
291298	with roof	300 cm	130 cm	195 cm	70 mm	1	7		
291293	without roof	250 cm	88 cm	123 cm	70 mm	1	7		
291347	with roof	115 cm	81 cm	131.5 cm	78 mm	1			
291345	without roof	112.5 cm	68.5 cm	116 cm	78 mm	1	16		

Ref. no.	Description	Material	Length	Width	Height	suitable for		€
291346	Roof for feed rack	hot-dip galvanised metal	115 cm	79.5 cm	22 cm	291345	1	

## Hay Net for Round Bales

- Feeding net for hay and silage bales for feed-saving roughage supply to horses
- Hay is no longer dispersed
- secure attachment by elastic cord
- tear-resistant and durable
- soft material, protects the horse's mouth
- universal use
- Rope thickness: 6 mm
- not recommended for horses with horseshoes due to risk of fouling
- Material: Polypropylene



Ref. no.	Colour	Height	Ø	Mesh size	 	€
3227439	green	140 cm	140 cm	4,5 x 4,5 cm	1/4 48	
321603	green	150 cm	150 cm	4,5 x 4,5 cm	1/4 32	
3227440	green	160 cm	160 cm	4,5 x 4,5 cm	1/4 40	
321604	green	180 cm	180 cm	4,5 x 4,5 cm	1/3 30	

## Hay Net for Round Bales

Hangable feeding net for hay and silage bales for feed-saving roughage supply to horses.

- Hay is no longer dispersed
- Fastening with integrated cable
- tear-resistant and durable
- soft material, protects the horse's mouth
- universal use
- Rope thickness: 6 mm
- Material: Polypropylene



Ref. no.	Colour	Height	Ø	Mesh size	 €
321605	green	160 cm	125 cm	4,5 x 4,5 cm	1/5
321606	green	180 cm	150 cm	4,5 x 4,5 cm	1/3

## Hay Bell for Round Bales

- for round bales with max. ø 160 x H 125 cm or ø 130 x H 135 cm
- shatter-proof, frost-proof plastic material with built-in UV protection
- sturdy construction
- with animal-friendly and non-damaging food openings
- water-removing rain channels over the food openings
- with integrated carrying handle, suitable for front loader forks
- with integrated fixing eyelets for fixing the base to the hay bell
- base (available separately) for dry storage of the bales – can be locked for transportation with the hay bell

14559







Technical data	14557	14558
Height	164 cm	164 cm
Exterior diameter	185 cm	185 cm
Interior diameter	160 cm	160 cm
Feed areas	5	10



Please note separate freight costs.



14557

14558

Ref. no.	Colour	Suitable for	 	€
14557	olive green	Cattle / Horses	1 6 	
14558	olive green	Sheep / Goats / Calves / Ponies	1 6 	

Ref. no.	Description	Colour	Material	suitable for	 €
14559	Base for Hay Bell	olive green	plastic, UV-stabilised	14557, 14558	1 
14556	Floor Anchor for Hay Bell and Base		metal	14557, 14558, 14559	1/10 

# Netting

Made in the EU



Fence netting is always the first choice when you want to cordon off an area quickly and easily to hold animals, or even to protect your property from wild animals. Sheep and goats place especially high demands on fence netting: Sheep are robust animals and also protected by their dense wool against electrical shocks. This is why care should be taken to select a powerful fence device (12 V or 230 V) for all netting, in order to achieve the maximum tending safety. Our fence nettings are available in different versions and thus suitable for all types of ground conditions and applications. The combination of robust plastic or fibreglass posts and high-quality conductor materials ensure the highest herding safety, both for professional sheep farmers as well as small animal husbandry in the hobby segment.

Stainless steel connection clip for the rapid connection of several nets!



extremely stable welded knots



Colour-contrasting head insulator on the starting post makes net set-up easy



Vertical: stiff plastic braces = improved footing



## Pasture net summary of sheep / goat and wolf nets

Ref. no.	Model	Page	horizontal colour	vertical colour	Length	Height	Premium	Single prong	Double prong	with vertical struts	can be electrified	with separately connectable ground wire	Plus/minus-capable net	sheep	goat	wolf	blank
27840	TitanNet Premium XBraid	218	●	●	50 m	122 cm	●	●			●			●	●	●	
27841	TitanNet Premium XBraid	218	●	●	50 m	122 cm					●			●	●	●	
27811	TitanNet Premium	210	●	●	50 m	90 cm					●			●	●	●	
27813	TitanNet Premium	210	●	●	50 m	108 cm					●			●	●	●	
27821	TitanNet Premium Plus	219	○	●	50 m	90 cm					●			●	●	●	
27823	TitanNet Premium Plus	219	○	●	50 m	108 cm					●			●	●	●	
27830	TitanNet Premium Vario	220	●	○	50 m	108 cm					●			●	●	●	
27831	TitanNet Premium Vario	220	●	○	50 m	108 cm					●			●	●	●	
27832	TitanNet Premium Vario	220	●	○	50 m	122 cm					●			●	●	●	
27833	TitanNet Premium Vario	220	●	○	50 m	122 cm					●			●	●	●	
27325	Titan Net	211	○	●	50 m	90 cm					●			●	●		
27326	Titan Net	211	○	●	50 m	90 cm					●			●	●		
27327	Titan Net	211	○	●	50 m	108 cm					●			●	●		
27328	Titan Net	211	○	●	50 m	108 cm					●			●	●		
27351	TitanLight Net	212	●	●	50 m	90 cm					●			●	●		
27352	TitanLight Net	212	●	●	50 m	90 cm					●			●	●		
27353	TitanLight Net	212	●	●	50 m	108 cm					●			●	●		
27354	TitanLight Net	212	●	●	50 m	108 cm					●			●	●		
27200	EasyNet	213	●	●	50 m	105 cm					●			●	●		
27910	TitanNet 145	223	○	●	25 m	145 cm					●			●	●	●	
27380	TitanNet 145	223	○	●	50 m	145 cm					●			●	●	●	
27852	OviNet Premium	214	●	●	50 m	90 cm					●			●	●	●	
27854	OviNet Premium	214	●	●	50 m	108 cm					●			●	●	●	
27251	OviNet	215	●	●	50 m	90 cm					●			●	●		
27252	OviNet	215	●	●	50 m	90 cm					●			●	●		
27253	OviNet	215	●	●	50 m	108 cm					●			●	●		
27254	OviNet	215	●	●	50 m	108 cm					●			●	●		
27266	OviNet	215	●	●	50 m	90 cm					●			●	●		
27268	OviNet	215	●	●	50 m	108 cm					●			●	●		
27388	OviNet Maxi	222	●	○	50 m	122 cm					●			●	●	●	
27394	OviNet Maxi	222	●	○	50 m	122 cm					●			●	●	●	
27215	WildNet	225	●	●	50 m	73 cm					●						●
27900	ClassicNet	216	●	●	50 m	90 cm					●			●	●		
27901	ClassicNet	216	●	●	50 m	90 cm					●			●	●		
27902	ClassicNet	216	●	●	50 m	108 cm					●			●	●		
27903	ClassicNet	216	●	●	50 m	108 cm					●			●	●		

Length

Single prong

can be electrified

Height

Double prong

with separately connectable ground wire

with PREMIUM Post

with vertical struts

Plus/minus-capable net

\* see detailed image above  
 \*\* for additional earthing along whole net length



# Discover the new generation of posts for pasture nets



The new PREMIUM posts are the latest innovation from AKO. Special attention was paid to the selection of the right materials during the development of these new posts. The combination of a high-strength thermoplastic and long fibreglass fibres provides excellent stability and rigidity. The glass-fibre reinforced material guarantees maximum UV resistance and durability. Compared to conventional posts, the new PREMIUM posts are significantly

stiffer and less susceptible to bending under tensile load (especially at the beginning or end of the net and in the corners). Thus, a reliable and upright stand of the net - even in adverse weather conditions - can be guaranteed. When designing the new head insulator, we incorporated the years of experience of professionals in the field. This, just like the ground nail, is

Special attention was paid to the everyday handling of the nets. Despite retaining the tried-and-tested diameter, it was possible to achieve slight reductions in the weight of the new post, thus enabling even more comfortable working.

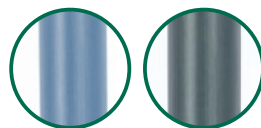
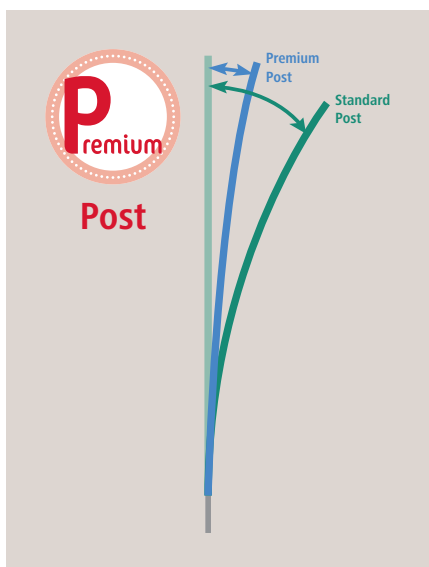

The posts in the following two colour variants are used in the AKO Premium nets:

- blue for sheep/wolf nets for better visibility for humans and animals
- anthracite for poultry nets for discreet colouring in gardens



sprayed inseparably with the post in the production process and guarantees a permanent hold. The new, rounded design of the head insulator prevents the wires from snagging when the nets are rolled up and out.



The galvanised ground nails the post have also been extended and provide even more secure anchorage in the soil - even in damp and soft ground.

Compared to conventional net posts, the nails (single and double prong) are firmly overmoulded at the end of the post and are thus securely and inseparably connected to the post.



## Curious to find out more?

Then see for yourself - all of our PREMIUM nets are already equipped with the new posts to meet the highest demands of professional animal husbandry.

European patent pending



Spare parts for pasture nets can be found at the end of the catalogue!

# AKO as a partner to professional sheep farmers

## ... with the ideal products

As a professional in your field, you need products that:

- Make your everyday life easier
- Are durable and robust
- offer added value
- Are easy and quick to assemble
- Are reliable and conductive!

We offer you the right solutions to support your day-to-day work!



THE lightest: OVI Premium

- 10 % lighter than comparable conventional nets
- especially friendly for small game

Item 27852 (90 cm) & 27854 (108 cm)

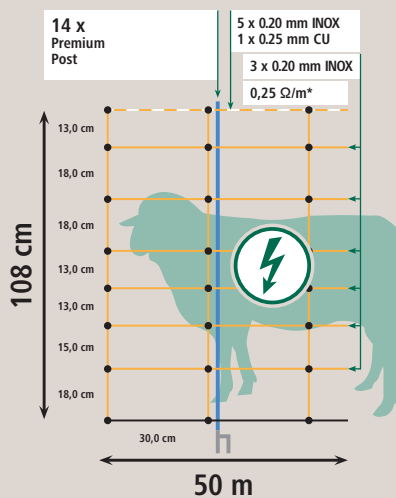

THE most flexible: TitanNet Premium Plus

- Flexible connectivity
- connectable ground wire prevents wild animal damage

Item 27821 (90 cm) & 27823 (108 cm)

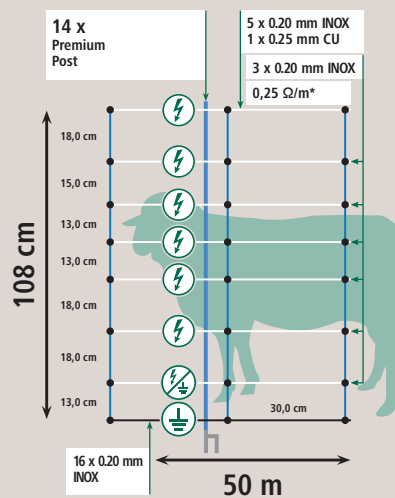

THE most robust: TitanNet Premium Xbraid

- wear-protected and long-lasting
- excellent conductivity

Item 27841 (122 cm) & 27840 (122 cm)

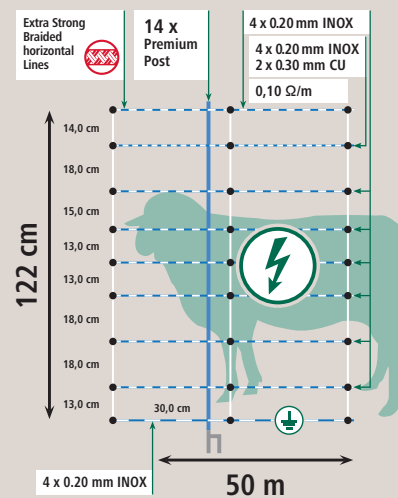

AKO Premium: recommended by professional sheep farmers!



... with the right quality that's Made in Europe!

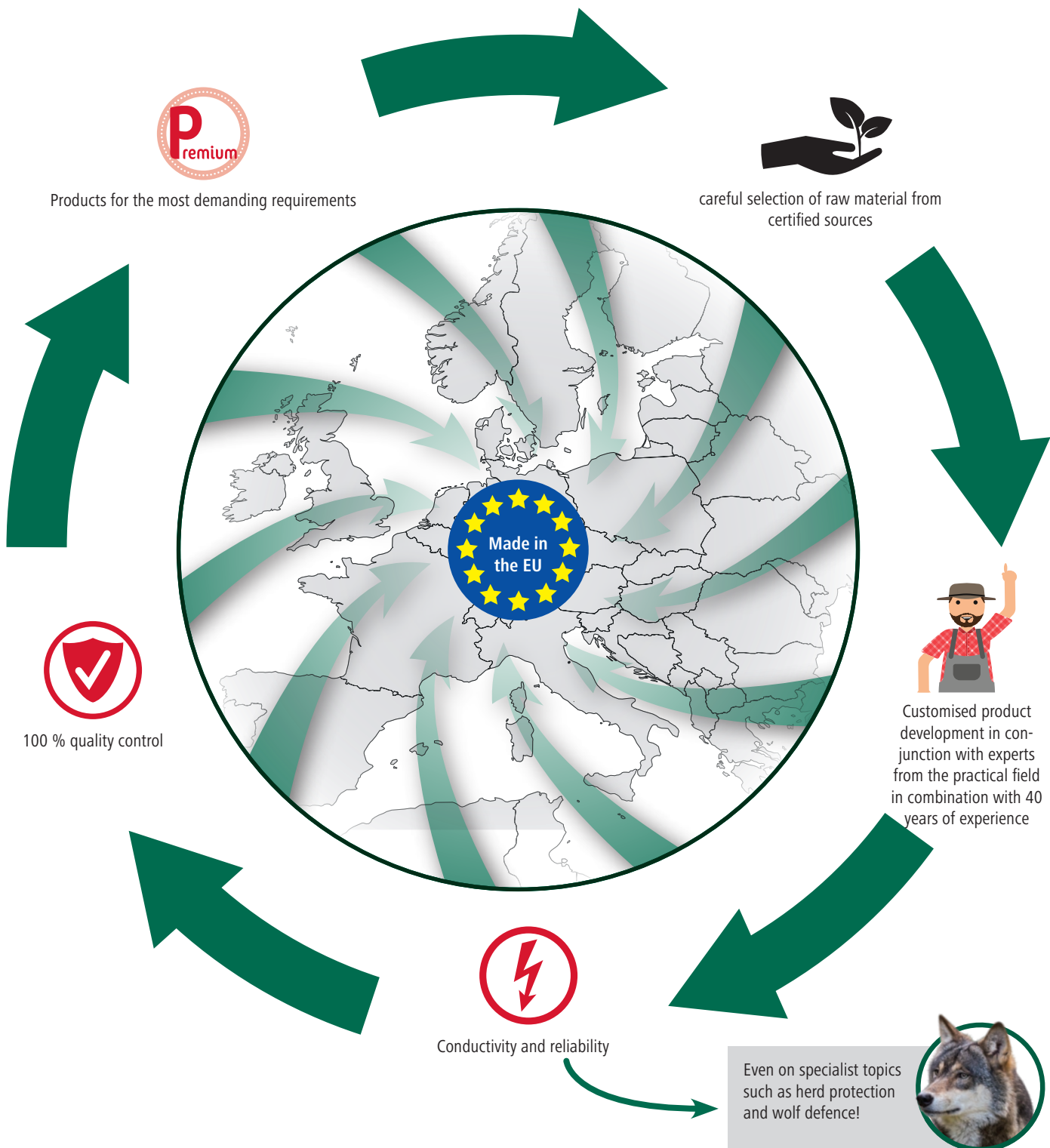

Discover many other solutions for sheep farming, from Aesculap clippers to breeding accessories in the Kerbl catalogue...

Ideal products from a dealer near you!  
Expert advice and information? You'll find it here ...





## AKO TitanNet Premium



Easy and fast repairs with our new Litzclip connectors.

### AKO TitanNet Premium

Our „classic“ from the TitanNet series in a new design and with the new patented PREMIUM posts.

In order to meet the premium demands of professional sheep farmers, we have equipped our proven TitanNet with the new PREMIUM posts and relaunched them with a high-contrast colour scheme. The close-meshed net guarantees maximum guarding safety even on uneven terrain by using rigid plastic struts in the vertical instead of soft wire material. These are permanently linked at intervals of 30 cm with the horizontal wires, ensuring stability even on hilly and uneven terrain.

- Height 90 cm (9 horizontal wires) or 108 cm (10 horizontal wires) available
- 14 extremely robust and stable PREMIUM posts with galvanised ground tip
- extremely stable welded knots
- strengthened, energized upper poly wire - increased conductivity thanks to the use of 5 stainless steel wires and a tin-plated copper wire
- new colour combination for better visibility for animals and humans
- we offer a 3-year warranty against UV damage for all plastic poly wires

3 year warranty of UV stability



Made in the EU

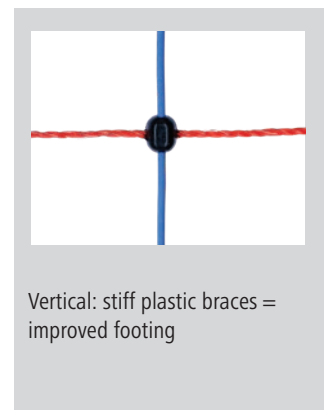
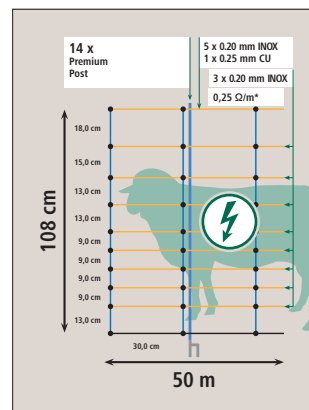
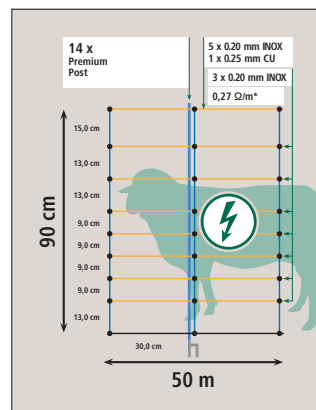
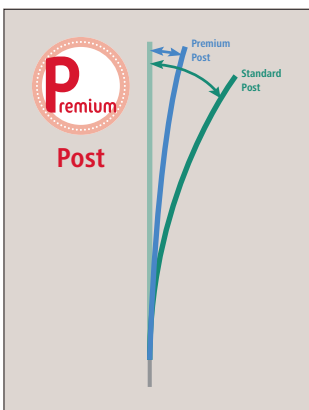

Vertical: stiff plastic braces = improved footing

\* Based on the total conductor cross-section of all live poly wires in the pasture netting

Ref. no.	Ground spike	Length	Height	Colour	Qty posts	Matching replacement post			€
27811	Double prong	50 m	90 cm	blue / orange	14	27805	1	24	
27813	Double prong	50 m	108 cm	blue / orange	14	27807	1	24	

## AKO TitanNet



### AKO TitanNet

The TitanNet is especially suitable for difficult terrain thanks to the use of our proven vertical struts. Vertically, rigid plastic struts are used instead of the soft wire material. These are permanently linked at intervals of 30 cm with the horizontal wires, ensuring a compact structure even on hilly and uneven terrain.

- height 90 cm (7 horizontal poly wires) or 108 cm (8 horizontal poly wires), each available with single or double prong
- sturdy plastic posts with galvanized bottom tip
- strengthened, energized upper poly wire - increased conductivity thanks to the use of 5 stainless steel wires and a tin-plated copper wire
- extremely stable welded knots
- with practical stainless steel clip for easy connection of multiple nets
- head insulator and ground stopper make self-loosening of the poly wire virtually impossible
- we offer a 3-year warranty against UV damage for all plastic poly wires



Easy and fast repairs with our new Litzclip connectors.

3 year warranty of UV stability



Made in the EU

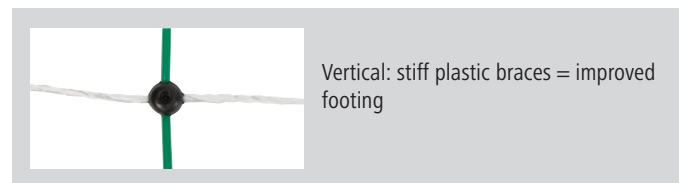
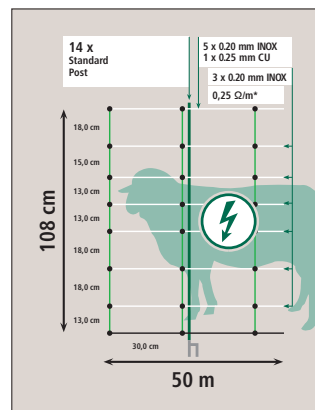
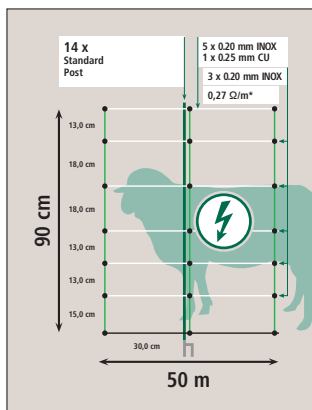

Vertical: stiff plastic braces = improved footing

- high quality at a good price
- suitable for hilly terrain
- even more stable plastic strips for optimal hold
- reinforced live upper wire with copper conductor - therefore especially conductive

\* Based on the total conductor cross-section of all live poly wires in the pasture netting

Ref. no.	Ground spike	Length	Height	Colour	Qty posts	Matching replacement post	€
27325	Single prong	50 m	90 cm	white / green	14	27346 1 24	
27326	Double prong	50 m	90 cm	white / green	14	27347 1 24	
27327	Single prong	50 m	108 cm	white / green	14	27348 1 24	
27328	Double prong	50 m	108 cm	white / green	14	27349 1 24	



## TitanLight Net



### TitanLight Net

Our „lightweight“ in the TitanNet range!

The increased mesh spacings allow ground game (e.g. hares and rabbits) and hedgehogs to pass safely, as well as providing a significant weight saving. This net is therefore extremely mobile, and particularly suitable for frequent repositioning. Vertically, rigid plastic struts are used instead of the soft poly wire material. These are permanently linked at intervals of 30 cm with the horizontal poly wires, ensuring a compact structure even on hilly and uneven terrain.

- Height 90 cm (5 horizontal poly wires) or 108 cm (6 horizontal poly wires), each available with single or double prong
- extremely stable welded knots
- 14 sturdy plastic posts with galvanized bottom tip
- strengthened, energized upper poly wire - increased conductivity thanks to the use of 5 stainless steel wires and a tin-plated copper wire
- we offer a 3-year warranty against UV damage for all plastic poly wires



Easy and fast repairs with our new Litzclip connectors.



3 year warranty of UV stability



Made in the EU

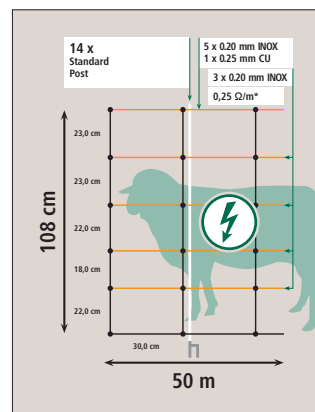
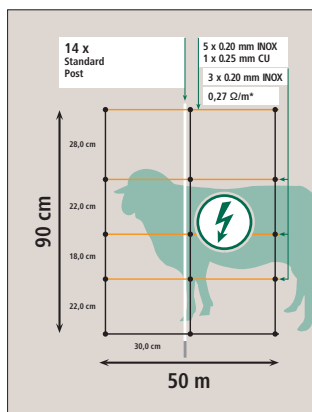

Vertical: stiff plastic braces = improved footing

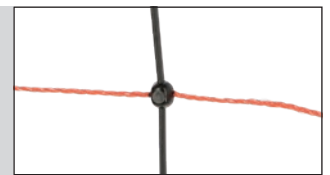

- increased mesh spacings - less power leakage in heavy vegetation
- easy handling due to light weight
- stable plastic struts for optimum stability - even in hilly terrain
- ground game and hedgehogs can "slip through" without risk

\* Based on the total conductor cross-section of all live poly wires in the pasture netting

Ref. no.	Ground spike	Length	Height	Colour	Qty posts	Matching replacement post			€
27351	Single prong	50 m	90 cm	orange / black	14	27202	1	30	
27352	Double prong	50 m	90 cm	orange / black	14	27203	1	30	
27353	Single prong	50 m	108 cm	orange / black	14	27229	1	30	
27354	Double prong	50 m	108 cm	orange / black	14	27230	1	30	



## AKO Easy Net



Easy and fast repairs with our new Litzclip connectors.

### AKO EasyNet

Sheep netting with ground separation - perfect conductivity even with heavy vegetation.

Extra-durable fibreglass poles ensure easy handling due to a small post diameter and noticeable weight reduction.

- 15 stable and very sturdy fibreglass posts
- Horizontal current conduction with 3 x 0.30 mm TriCOND conductors per poly wire - very good conductivity and long durability
- galvanised ground spike on fibreglass stake with plastic step
- with additional black vertical bars every 90 cm
- ground clearance makes mowing easier and decreases the conduction through the vegetation
- especially fast attachment and removal due to large mesh size
- we offer a 3-year warranty against UV damage for all plastic poly wires

3 year warranty of UV stability



Made in the EU



- especially fast attachment and removal due to large mesh size
- extremely stable and resistant fibreglass posts
- very high conductivity thanks to proven 3 x 0.30 mm TriCOND conductor material
- easy handling due to light weight

with reinforced black vertical bars, spacing 90 cm

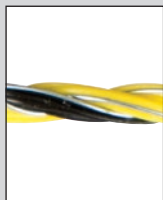

#### All conductors: TriCond = 5 x higher conductivity than stainless steel conductors

TriCOND conductor wires are 5 times more conductive than standard stainless steel wires of the same diameter, and therefore provide maximum security – even over long stretches. The special coating on these wires makes the material more robust and ensures long durability.

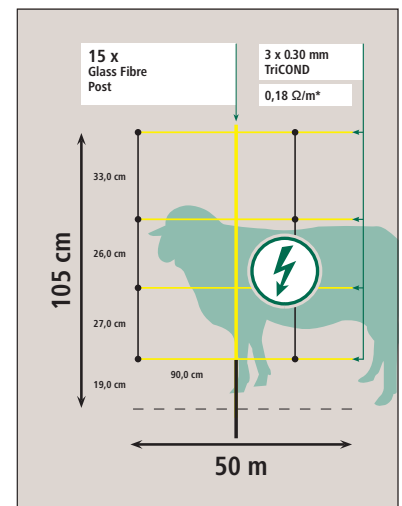

\* Based on the total conductor cross-section of all live poly wires in the pasture netting

Ref. no.	Ground spike	Length	Height	Colour	Qty posts	Matching replacement post	€
27200	Single prong	50 m	105 cm	yellow / black	15	27201 1 40	

Ref. no.	Description	Ground spike	Colour	Material	Post height	€
27201	Spare Post	Single prong	yellow	fibreglass	105 cm	1/50
44428	Spare Insulator for Oval Steel Post		black	Plastic		1/25/1000

## AKO OviNet Premium



The net for professional sheep farmers: especially lightweight, since 10 % lighter than conventional comparable nets!

### AKO OviNet Premium

- the proven mesh width of 30 cm from the Titan nets is now also available as an Ovi net with robust and resistant plastic strands: this combination significantly reduces the overall weight of the net and makes it a comfortable lightweight helper for professional users' daily work
- extremely durable PREMIUM posts for maximum stability and weather resistance with galvanised double prong
- equipped with a particularly conductive combination of copper and stainless steel wires, this mesh boasts super-low resistance (0.27 or 0.25 Ohm/m) and therefore keep the animals being protected inside the fence, but also attackers from outside away
- reinforced, current-carrying top wire as a lifeline for the entire net - increased conductivity throughout the entire course of the net

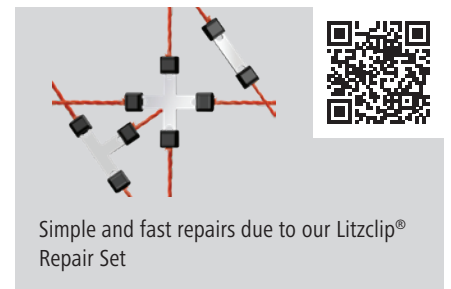

10 % lighter than comparable conventional nets



New product

NEW

3 year warranty of UV stability



Made in the EU

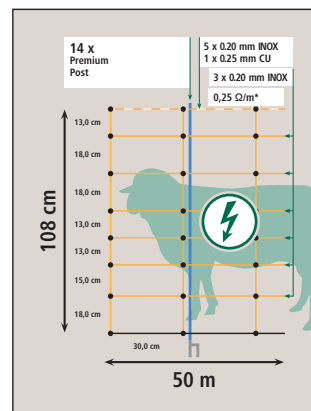
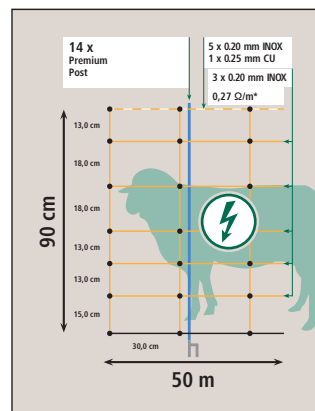
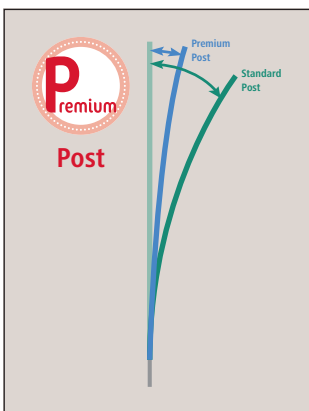

\* Based on the total conductor cross-section of all live poly wires in the pasture netting

Ref. no.	Ground spike	Length	Height	Colour	Qty posts	Matching replacement post	€
27852	Double prong	50 m	90 cm	orange	14	27805	1 30
27854	Double prong	50 m	108 cm	orange	14	27807	1 30



## AKO OviNet



**Top Seller**

### AKO OviNet

Our proven electrifiable sheep nets for universal use

- height 90 cm (9 horizontal poly wires) or 108 cm (10 horizontal poly wires)
- sturdy plastic posts with galvanized bottom tip
- Horizontal current conduction with 3 x 0.20 mm stainless steel conductors per poly wire
- strengthened, energized upper poly wire - increased conductivity thanks to the use of 5 stainless steel wires and a tin-plated copper wire
- extremely stable welded knots
- head insulator and ground stopper make self-loosening of the poly wire virtually impossible
- we offer a 3-year warranty against UV damage for all plastic poly wires

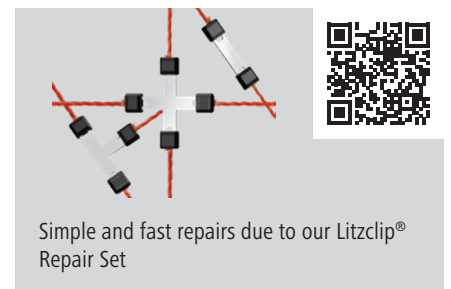

Especially well suited for use with several nets in a row.  
Optimum current supply to the most remote sheep net, thanks to galvanised copper conductor in the top strand of wire. 20 times higher conductivity than standard nets!

3 year warranty of UV stability



Made in the EU



Available in orange and green.

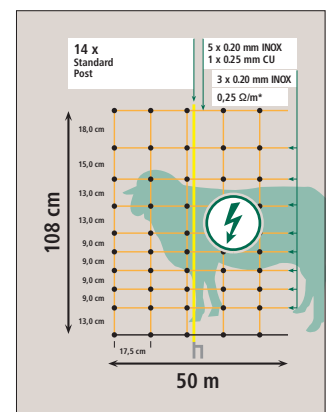
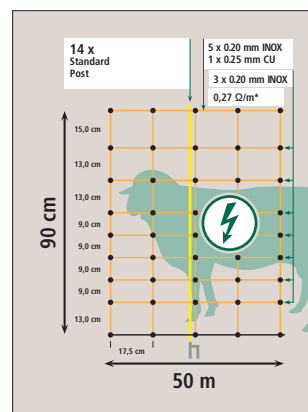
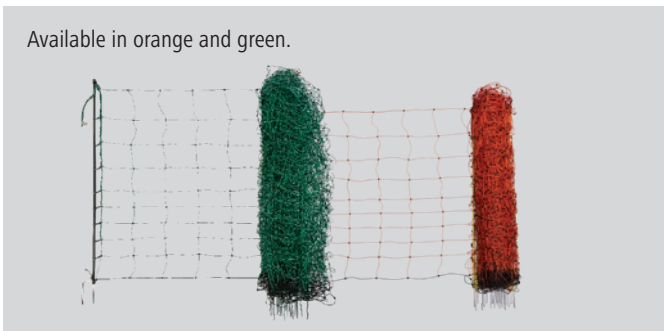

\* Based on the total conductor cross-section of all live poly wires in the pasture netting

Ref. no.	Ground spike	Length	Height	Colour	Qty posts	Matching replacement post	€
27251	Single prong	50 m	90 cm	orange	14	27301	1 30
27252	Double prong	50 m	90 cm	orange	14	27303	1 30
27253	Single prong	50 m	108 cm	orange	14	27305	1 30
27254	Double prong	50 m	108 cm	orange	14	27304	1 30
27266	Double prong	50 m	90 cm	green	14	27277	1 30
27268	Double prong	50 m	108 cm	green	14	27279	1 30



## ClassicNet



### ClassicNet

- height 90 cm (7 horizontal poly wires) or 108 cm (8 horizontal poly wires), each available with single or double prong
- sturdy plastic posts with galvanized bottom tip
- Horizontal current conduction with 3 x 0.20 mm stainless steel conductors per poly wire
- strengthened, energized upper poly wire - increased conductivity thanks to the use of 5 stainless steel wires and a tin-plated copper wire
- extremely stable welded knots
- with practical stainless steel clip for easy connection of multiple nets
- head insulator and ground stopper make self-loosening of the poly wire virtually impossible
- we offer a 3-year warranty against UV damage for all plastic poly wires

3 year warranty of UV stability



Made in the EU

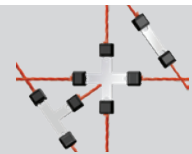

Simple and fast repairs due to our Litzclip® Repair Set

- high quality at a good price
- improved nodes for higher breaking strength
- reinforced live upper wire with copper conductor - therefore especially conductive

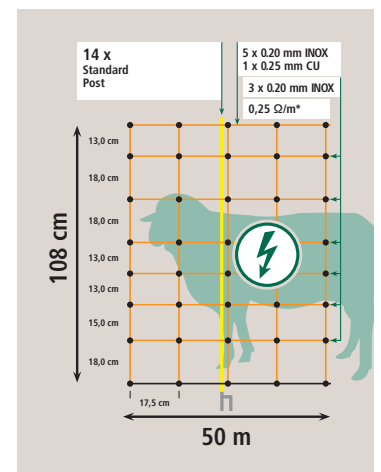
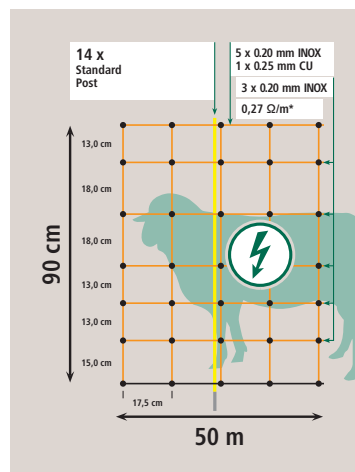

\* Based on the total conductor cross-section of all live poly wires in the pasture netting

Ref. no.	Ground spike	Length	Height	Colour	Qty posts	Matching replacement post		€
27900	Single prong	50 m	90 cm	orange	14	27301	1 30	
27901	Double prong	50 m	90 cm	orange	14	27303	1 30	
27902	Single prong	50 m	108 cm	orange	14	27305	1 30	
27903	Double prong	50 m	108 cm	orange	14	27304	1 30	



Scan the QR code for further information



## The return of wolves

The spread of the wolf in the cultivated landscape holds a potential for conflict. As food opportunists, they prey on animals that they can capture most easily - but if the hunger is great enough or the deterrent not strong enough, they are quite willing to expend considerable effort to reach their hunting target.

These are, above all, domestic animals such as sheep and goats. This makes protecting the herd an important issue. Whereas the focus used to be on guarding livestock, it is now imperative that the entry of wolves from the outside is also taken into account when building fences. Wolves are very quick to learn and are always developing new strategies to overcome enclosures. Pasture fences should therefore be adequately protected against them jumping or climbing over, slipping through or digging under them. Wolf defence experts agree that electric fences are the best means of choice for keeping wolves at bay.

Generally speaking, herd protection measures are required for livestock species that are particularly at risk from wolves, such as sheep and goats. To create a wolf-deterrent minimum level of protection, the setup of electrically charged utility mesh or wire fences with a minimum height of 90 cm is required. Please also be aware that different specifications may apply, including in relation to requirements, depending on the federal state or region. Other requirements and information can also be found in DIN VDE Standard 0131, as well as the Electric Fence Guidelines VDE SPEC 90006 in their respective most recent version.

## Signalling Band

- Signalling band: early visual scaring of wolves as an additional safety function for your sheep!
- Material: Plastic

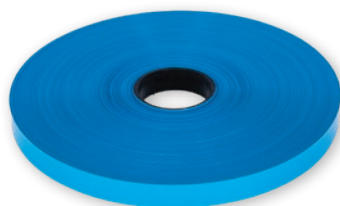

Ref. no.	Colour	Length	Width		€
27240	blue	250 m	25 mm	1	

## Herd Protection Band

- Herd protection band for additional visual and acoustic deterrence
- made from 100 % recycled materials
- Material: Plastic

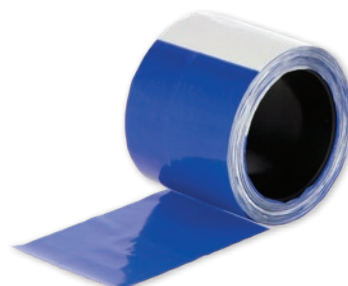

Ref. no.	Colour	Length	Width		€
27239	blue / white	100 m	80 mm	1/24	

# AKO TitanNet Premium XBraid



## AKO TitanNet Premium XBraid

Our professional net with extremely robust, braided wires!

TitanNet XBraid Premium nets are the safe, simple and efficient solution for protecting your animals. With its reliably high conductivity and robust construction, it provides an effective barrier against unwanted intruders.

3 year warranty of UV stability



Made in the EU



- Height 122 cm with 9 horizontal braided wires, with stainless steel and copper conductors
- 14 extremely robust and stable PREMIUM posts with galvanised ground tip
- Conductor material in the stranded wire runs continuously on the outside and always ensures optimum contact when animals touch it
- high tensile strength and robustness of the wires make this net particularly durable
- extremely stable welded knots
- easy assembly and disassembly thanks to the combination of PREMIUM posts and robust braided wires, resulting in fewer tangles
- improved footing and optimal terrain adaptation thanks to stable vertical struts every 30 cm
- particularly good visibility due to the colour combination of blue/white - ideal for use when defending against wild animals and wolves
- additional thick, tin-plated copper conductors in the differently coloured 2nd wire from the top wire ensure minimum electrical resistance and maximum conductivity
- we offer a 3-year warranty against UV damage for all plastic poly wires
- optionally connectable, reinforced grounding wire for earthing along the whole length of the net under difficult ground conditions (e.g. very sandy or dry soils), as well as to prevent wild animal damage

### THE wolf defence net for professional sheep and goat farmers!

- The combination of braided wires and the innovative PREMIUM posts make this net the ideal solution for professional users, including for protecting livestock.
- This combines the advantages of rigid vertical struts, particularly robust posts and braided wires instead of the usual twisted strands: the result is a particularly durable net with excellent conductivity and stability.

Easy and fast repairs with our new Litzclip connectors.

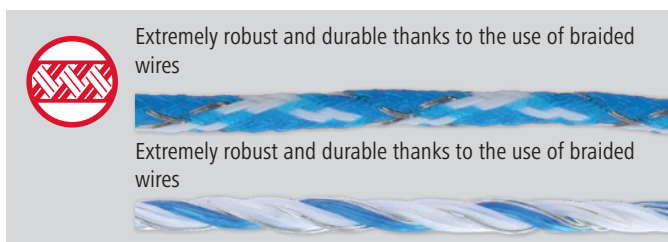
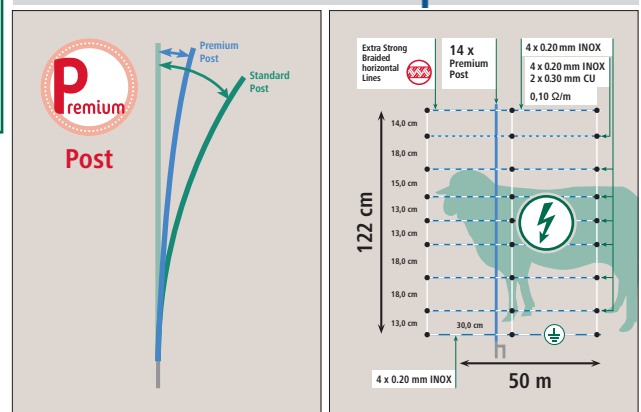
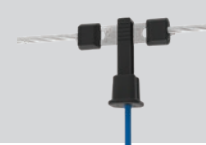

\* Based on the total conductor cross-section of all live poly wires in the pasture netting

Ref. no.	Ground spike	Length	Height	Colour	Qty posts	Matching replacement post			€
27840	Single prong	50 m	122 cm	white / blue	14	27808	1	24	
27841	Double prong	50 m	122 cm	white / blue	14	27809	1	24	



# AKO TitanNet Premium Plus



Important: for wolf defence, the first live wire must run max. 20 cm above the ground.

## AKO TitanNet Premium Plus

Our „all-rounder“ from the TitanNet series with the new patented PREMIUM posts.

Equipped with the new PREMIUM net posts, we combine in this new net the proven strengths of our TitanNet sheep nets with versatile connection options for professional use in sheep rearing. Vertically, rigid plastic struts are used instead of the soft wire material. These are permanently linked at intervals of 30 cm with the horizontal wires, ensuring a compact structure even on hilly and uneven terrain.

- height 90 cm (7 horizontal wires) or 108 cm (8 horizontal wires)
- 14 extremely robust and stable PREMIUM posts with galvanised ground tip
- extremely stable welded knots
- strengthened, energized upper poly wire - increased conductivity thanks to the use of 5 stainless steel wires and a tin-plated copper wire
- we offer a 3-year warranty against UV damage for all plastic poly wires
- optionally connectable, reinforced grounding poly wire for earthing along the whole length of the net under difficult ground conditions (e.g. very sandy or dry soils)
- in addition, the 2nd poly wire above the ground is fitted with a separate stainless steel connection terminal, and can therefore be used flexibly
- particularly good visibility due to the colour combination of blue/white - ideal for use when defending against wild animals and wolves

3 year warranty of UV stability



Made in the EU



Connection options:

- ground wire (conductive) can be connected to the device's earth output, for additional earthing along the entire length of the net
- 2. wire above ground can optionally be disconnected from the power circuit of the wires positioned above it, to decrease power leakage in heavy vegetation

16 stainless steel conductors combined with thick PE threads in the grounding poly wire prevent browsing by game

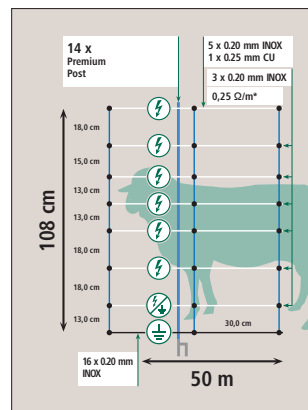
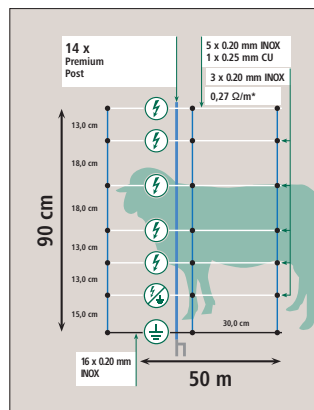
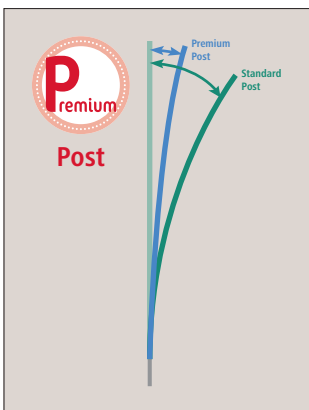

Scan the QR code for further information

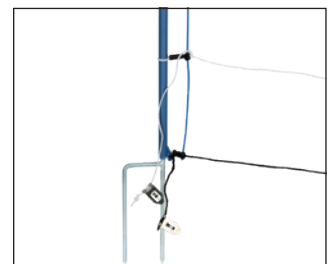

\* Based on the total conductor cross-section of all live poly wires in the pasture netting

Ref. no.	Ground spike	Length	Height	Colour	Qty posts	Matching replacement post	€
27821	Double prong	50 m	90 cm	blue / white	14	27805	24
27823	Double prong	50 m	108 cm	blue / white	14	27807	24

# AKO TitanNet Premium Vario



Important: for wolf defence, the first live wire must run max. 20 cm above the ground.

## AKO TitanNet Premium Vario

Our versatile wolf defence net from the TitanNet series with the new patented PREMIUM posts!

We have worked with experts in the field of wolf defence to completely revise our wolf net, finding you the perfect compromise between user-friendliness and effective herd protection. The new, innovative and highly robust PREMIUM posts give the net maximum stability and sturdiness. In addition to the greatest possible guarding security, special attention was paid to the defence against intruders from outside with this net. The special +/- principle makes the TitanNet Premium Vario our most versatile net and you can adapt it to suit your own individual situation. The vertical struts, tried and true for many years, provide a sturdy hold even on hilly and uneven terrain.

- height 108 cm (8 horizontal wires) or 122 cm (9 horizontal wires), each available with single or double prong
- 14 extremely robust and stable PREMIUM posts with galvanised ground tip
- extremely stable welded knots
- optionally connectable, reinforced grounding poly wire for earthing along the whole length of the net under difficult ground conditions (e.g. very sandy or dry soils)
- improved footing and optimal terrain adaptation thanks to stable vertical struts every 30 cm
- we offer a 3-year warranty against UV damage for all plastic poly wires

3 year warranty of UV stability 

Made in the EU 

Ref. no.	Ground spike	Length	Height	Colour	Qty posts	Matching replacement post		€
27830	Single prong	50 m	108 cm	white / blue	14	27806	24	
27831	Double prong	50 m	108 cm	white / blue	14	27807	24	
27832	Single prong	50 m	122 cm	white / blue	14	27808	24	
27833	Double prong	50 m	122 cm	white / blue	14	27809	24	



## +/- principle – more intensive pulses for maximum security.

In plus/minus fence systems, the conductors are connected alternately to the fence terminal (+) and the earth terminal (-) of your electric fence unit via conductor bundling clips. The resulting earth wires intensify the electric shock to the animal even in difficult ground conditions, such as dry, sandy or snow-covered ground.

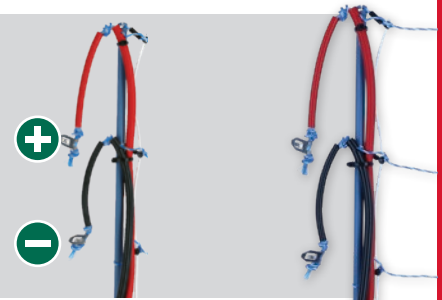

### Connection options:

- PLUS net
- PLUS net with earthing via the grounding wire
  - improved grounding for dry soils
  - strong electric shock when the grounding wire and the conductive wire above it are contacted simultaneously during an attempt to burrow underneath
- PLUS/MINUS net



Scan the QR code for further information

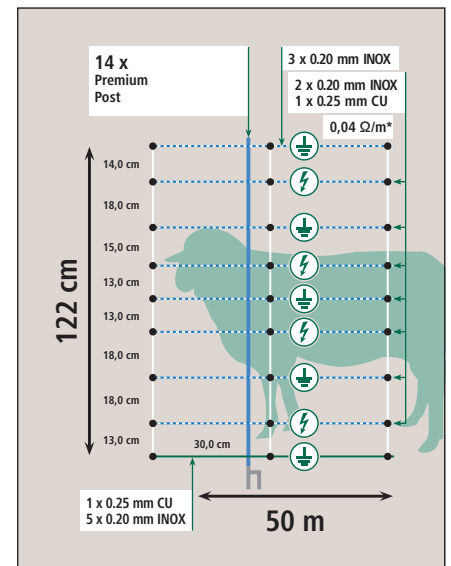
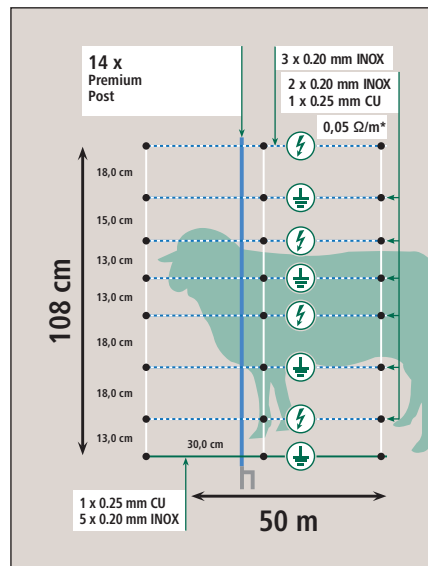
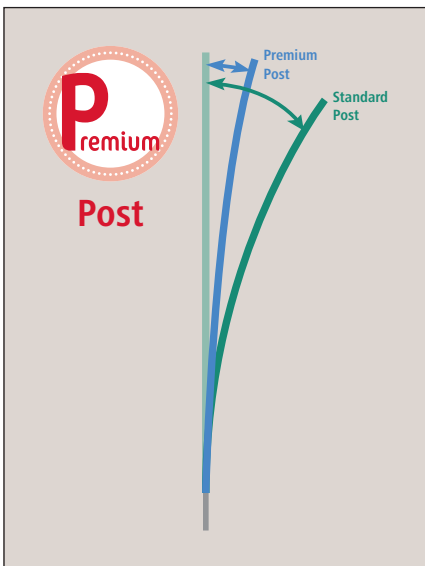
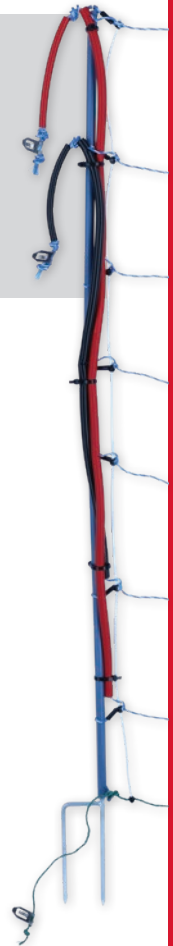

\* Based on the total conductor cross-section of all live poly wires in the pasture netting



WolfStop (27256) as an ideal addition and for height extension

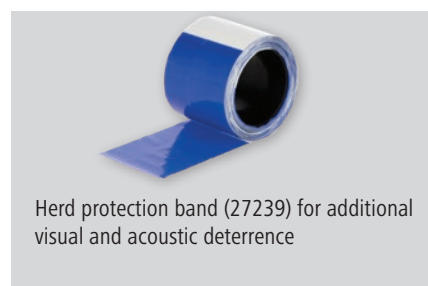

Herd protection band (27239) for additional visual and acoustic deterrence

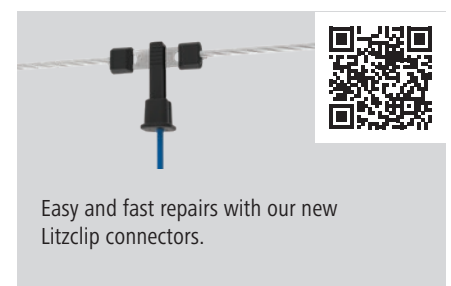

Easy and fast repairs with our new Litzclip connectors.





## AKO OviNet Maxi



### AKO OviNet Maxi

Our new, extra-high OviNet especially for wolf defence

- 14 integrated white plastic posts with galvanised ground spike
- 9 x TriCOND rows of 3 x 0.30 mm offer maximum conductivity
- extremely stable welded knots
- optionally connectable, reinforced grounding poly wire for earthing along the whole length of the net under difficult ground conditions (e.g. very sandy or dry soils)
- we offer a 3-year warranty against UV damage for all plastic poly wires

3 year warranty of UV stability



Made in the EU



#### Connection options:

- ground wire (conductive) can optionally be connected to the device's earth output, for additional earthing along the entire length of the net

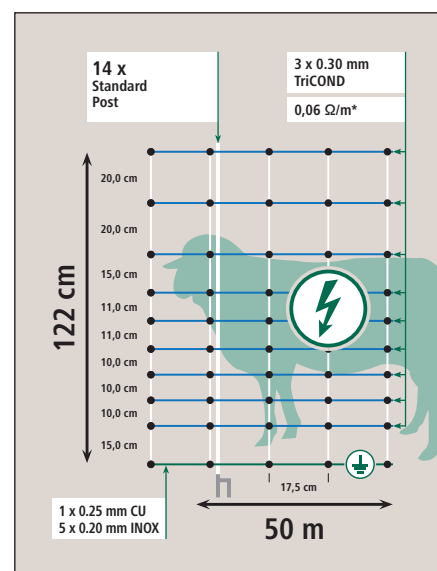
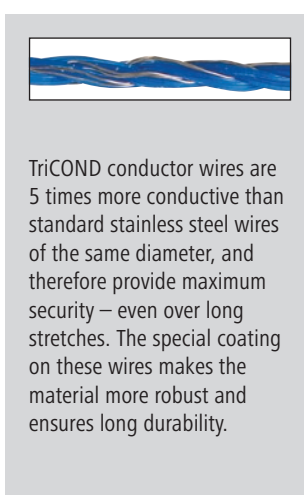
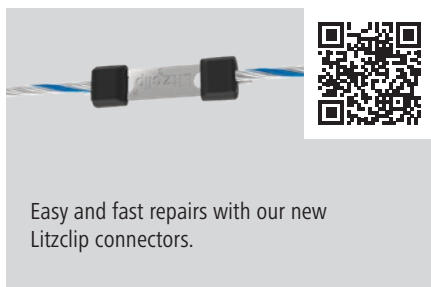

\* Based on the total conductor cross-section of all live poly wires in the pasture netting

Ref. no.	Ground spike	Length	Height	Colour	Qty posts	Matching replacement post	€
27388	Single prong	50 m	122 cm	white / blue	14	27376	30
27394	Double prong	50 m	122 cm	white / blue	14	27375	30

## AKO TitanNet 145



These particularly high nets are also ideal for setting up mobile night pens for controlled overnight accommodation and for herd protection.

### AKO TitanNet 145

Maximum height for maximum (wild animal) protection - our highest net from the TitanNet series.

When developing this new member of the TitanNet series, the primary premise was to offer the greatest possible protection against the intrusion of wild animals from the outside. Jumping over this net is almost impossible. The extra-strong PVC posts with a diameter of 19 mm and galvanised double prong provide a secure and firm stand. Due to the height of 145 cm above ground, this net is also suitable as a guarding net for horses, ponies, donkeys or alpacas. The vertical struts, tried and true for many years, provide a sturdy hold even on hilly and uneven terrain.

- height 145 cm (11 horizontal wires)
- extra-strong posts with 19 mm diameter and galvanised bottom tip (double prong)
- extremely stable welded knots
- strengthened, energized upper poly wire - increased conductivity thanks to the use of 5 stainless steel wires and a tin-plated copper wire
- head insulator and ground stopper make self-loosening of the poly wire virtually impossible
- optionally connectable, reinforced grounding poly wire for earthing along the whole length of the net under difficult ground conditions (e.g. very sandy or dry soils)
- improved footing and optimal terrain adaptation thanks to stable vertical struts every 30 cm
- we offer a 3-year warranty against UV damage for all plastic poly wires

3 year warranty of UV stability



Made in the EU



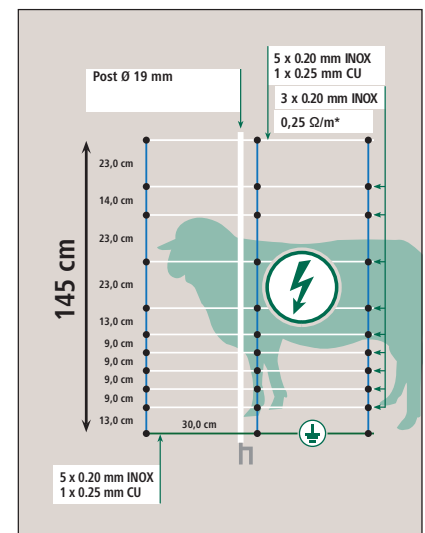
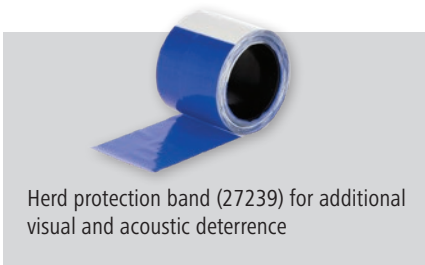

#### Connection options:

- ground wire (conductive) can optionally be connected to the device's earth output, for additional earthing along the entire length of the net



\* Based on the total conductor cross-section of all live poly wires in the pasture netting

Ref. no.	Ground spike	Length	Height	Colour	Qty posts	Matching replacement post			€
27910	Double prong	25 m	145 cm	blue / white	8	27360	1	28	
27380	Double prong	50 m	145 cm	blue / white	15	27360	1	24	





### 3 possible applications in one solution:

- as dig-under protection = mounting on the post 20 cm above ground at a 90° angle (Item 1.A), retract and electrify the wire - fix at 0° angle (Item 1.B) for mowing, removing, or rolling up the net
- as jump-over protection = mounting on the top end of the post at a 45° angle (Pos. 2), retract the wire and electrify it
- as height extension = mounting on the top end of the post at a 0° angle (Item 3), retract the electrified wire or signal tape

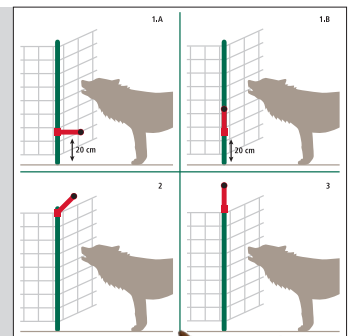

## Supplementary Set for Pasture Nets WolfStop

The flexible and safe solution against wolves: can be used both as dig-under and jump-over protection, as well as to increase the height of the net, keeping wolves at bay!

- 10-piece set for mounting on all commercially net posts
- supports can be secured in their holders at 3 defined angles
- the net can be rolled up easily and put to one side/stored by locking the support parallel to the post (position 1.B)
- the conductor material line (electrified) made possible by the WolfStop keeps the wolf away from the net and therefore away from the animals being protected
- if the WolfStop is used mainly as a height extension, then a signal tape (item 27240, optionally available) can be used for scaring purposes
- the additional conductor material line must be operated with the same device as the net itself
- in the case of horned sheep and goats, a distance strand can be drawn on the inside of the net to the electrified wolf defence fence
- mounted on posts in the poultry netting and equipped with an electrified wire, the WolfStop also keeps foxes away from the poultry run (mounting in position 1.A, ideally close to the ground)
- can be used for: posts max. 16 mm diameter



Awarded the silver DLG Innovation Prize in 2022

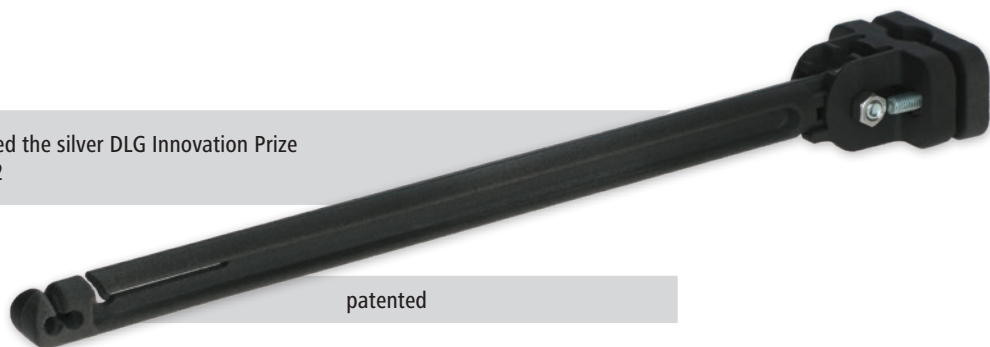

Ref. no.		€
27256	1/56	

Set consisting of:  
 10 x support,  
 10 x connecting terminal,  
 10 x screw and nut set (M5)



Ref. no.	Description	Colour	Material	Length	Width		€
27240	Signalling Band	blue	Plastic	250 m	25 mm	1	
449312	Poly Wire Premium WildHog	blue		400 m		1/6	



## AKO WildNet



patented

Made in the EU



### AKO WildNet

The straightforward solution for keeping wild animals at bay!

- 3 x TriCOND rows, white/blue with 3 x 0.30 mm TriCOND wires each provide optimum conductivity (up to 10.000 m fence length)
- 12 x blue fibreglass posts, post distance approx. 4.5 m
- incl. accessories: Jointing sleeves (item no. 27321), 3 x base anchors (item no. 27322) with black nylon cord for de-tensioning, repair poly wire, and warning sign
- 25 mm blue signal tape is available as a separate accessory (250 m), item no. 27240
- we offer a 3-year warranty against UV damage for all plastic poly wires

3 year warranty of UV stability



### Wild animal deterrent guide

Browse the new AKO wild animal deterrent guide online or request your free copy by e-mail at [info@kerbl.com](mailto:info@kerbl.com)!



#### The advantages of WildNet:

- Quicker to assemble and disassemble than conventional electric fences
- ground clearance (better for mowing and significantly fewer diversions, i.e. more power to the fence)
- Blue 25 mm plastic signal tape (250 m, item no. 27240) can be added to improve visibility
- Nets are easy to connect with each other (the connector is integrated into the net, separate connectors are not required)

In windy areas, we recommend that you cut the signal tape (27240) into several pieces (approx. 50 – 100 cm) and secure each piece to the top of each post. The fluttering of the tape in the wind keeps wild boar at bay more effectively.

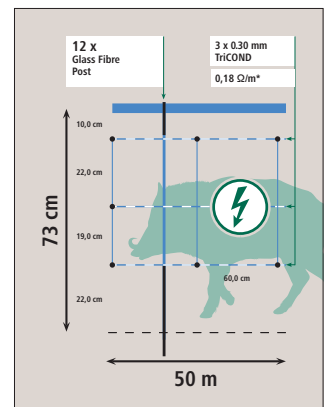
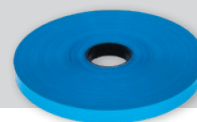

\* Based on the total conductor cross-section of all live poly wires in the pasture netting

Recommended! For the best possible securing of your fence, we recommend: Mobil Power AN 6000 (441136) starter kit



Ref. no.	Ground spike	Length	Colour	Qty posts	Matching replacement post			€	
27215	Single prong	50 m	white / blue	12	27217	1	70		
Ref. no.	Description	Ground spike	Colour	Material	Post height	Length	Width		€
27217	Spare Post	Single prong	blue	fibreglass	90 cm			1/10	
27240	Signalling Band		blue	Plastic		250 m	25 mm	1	
44428	Spare Insulator for Oval Steel Post		black	Plastic				1/25/1000	



## Mobile horse fence

- flexible complete solution to demarcate portion pastures or paddock plots for horses and ponies
- height 120 cm (4 horizontal wires)
- 30 cm ground clearance prevents unwanted discharge where there is vegetation
- white colouring is clearly visible to horses
- extra-strong jumbo posts with 19 mm diameter and galvanised bottom tip (double prong)
- for mobile fencing of horses, several nets can be combined with each other
- head insulator and ground stopper make self-loosening of the poly wire virtually impossible
- improved footing and optimal terrain adaptation thanks to stable vertical struts every 30 cm
- extremely stable welded knots
- we offer a 3-year warranty against UV damage for all plastic poly wires



New product

NEW

3 year warranty of UV stability



Made in the EU

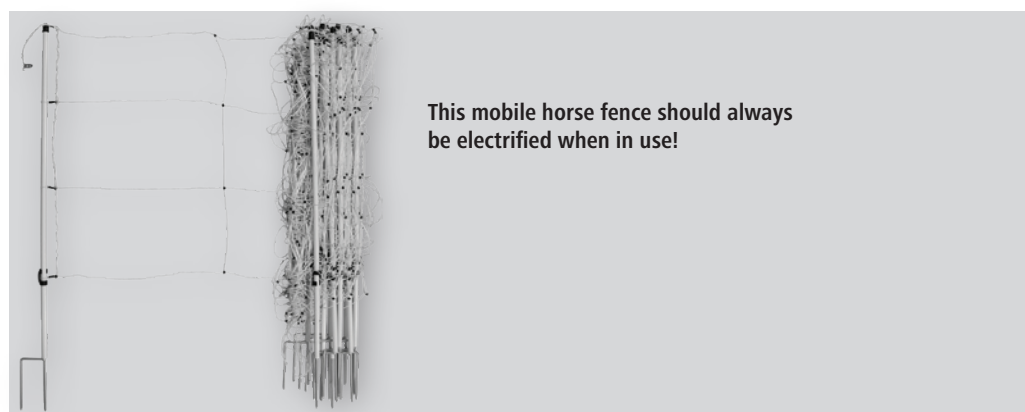
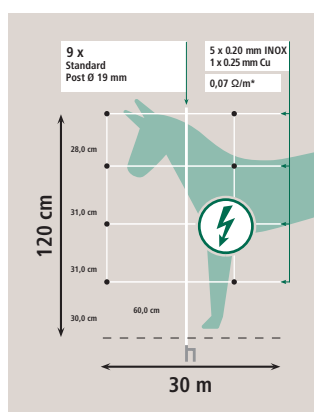

Ref. no.	Ground spike	Length	Height	Colour	Qty posts	Matching replacement post	 	€
27939	Double prong	30 m	120 cm	white	9	27360	1 30	



## Pasture net summary

Ref. no.	Model	Page	horizontal colour	vertical colour										
					↔	↕	P	†	h	⚡	🐔	🐕	🐖	🐰
292209	Rabbit Netting	225	●	●	12 m	65 cm		●		●				●
292216	Rabbit Netting	225	●	●	25 m	65 cm		●		●				●
292221	Rabbit Netting	225	●	●	50 m	65 cm		●		●				●
292222	Rabbit Netting	225	●	●	50 m	65 cm			●	●				●
292414	PoultryNet Premium	226	●	●	25 m	106 cm	●		●	●	●		●	
292420	PoultryNet Premium	226	●	●	50 m	106 cm	●		●	●	●		●	
292419	PoultryNet Premium	226	●	●	25 m	106 cm	●		●	●	●		●	
292418	PoultryNet Premium	226	●	●	50 m	106 cm	●		●	●	●		●	
292410	PoultryNet Premium	226	●	●	50 m	122 cm	●	●		●			●	
292411	PoultryNet Premium	226	●	●	50 m	122 cm	●		●	●			●	
292412	PoultryNet Premium	226	●	●	50 m	122 cm	●	●		●			●	
292413	PoultryNet Premium	226	●	●	50 m	122 cm	●		●	●			●	
292270	PoultryNet	227	●	●	50 m	106 cm		●		●			●	
292271	PoultryNet	227	●	●	50 m	106 cm			●	●			●	
292274	PoultryNet	227	●	●	15 m	106 cm			●	●			●	
292273	PoultryNet	227	●	●	25 m	106 cm			●	●			●	
292272	PoultryNet	227	●	●	50 m	106 cm			●	●			●	
292279	PoultryNet	227	●	●	25 m	106 cm			●	●			●	
292276	PoultryNet	227	●	●	50 m	106 cm		●		●			●	
292278	PoultryNet	227	●	●	50 m	106 cm			●	●			●	
292226	CampingNet	230	●	●	20 m	80 cm		●				●	●	●
292227	CampingNet	230	●	●	20 m	80 cm			●			●	●	●



Length



Single prong



can be electrified



Height



Double prong



with PREMIUM Post



Spare parts for pasture nets can be found at the end of the catalogue!

Scan the code and watch the video!





## AKO PoultryNet Premium

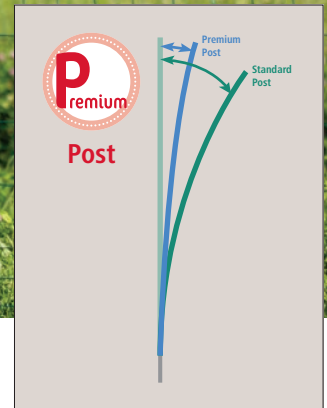

### AKO PoultryNet Premium

can be electrified

Our optionally electrifiable poultry nets impress with proven quality and innovative new posts. The extremely robust and stable PREMIUM posts offer absolute stability and prevent the nets from sagging. The narrow mesh size in the lower part of the net makes these nets ideal for chickens, geese and turkeys as well as for lambs.

- extremely robust and stable PREMIUM posts with galvanised ground tip
- extremely stable welded knots
- particularly small mesh width in the lower area of the net
- we offer a 3-year warranty against UV damage for all plastic poly wires

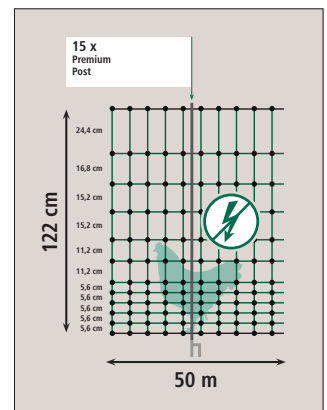
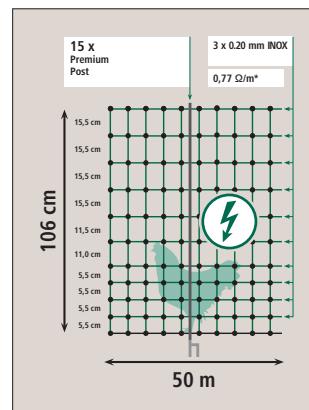
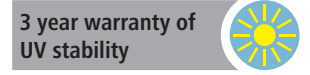

### AKO PoultryNet Premium

can be electrified

Ref. no.	Ground spike	Length	Height	Colour	Qty posts	Matching replacement post		€
292414	Double prong	25 m	106 cm	green	9	292401	1 30	
292420	Double prong	50 m	106 cm	green	15	292401	1 16	
292412	Single prong	50 m	122 cm	green	15	292407	1 18	
292413	Double prong	50 m	122 cm	green	15	292408	1 18	

we recommend the use of electrifiable nets for turkeys and geese

### PoultryNet Premium

not electrifiable

Ref. no.	Ground spike	Length	Height	Colour	Qty posts	Matching replacement post		€
292419	Double prong	25 m	106 cm	green	8	292401	1 30	
292418	Double prong	50 m	106 cm	green	15	292401	1 16	
292410	Single prong	50 m	122 cm	green	15	292407	1 18	
292411	Double prong	50 m	122 cm	green	15	292408	1 18	

\* Based on the total conductor cross-section of all live poly wires in the pasture netting

# PoultryNet

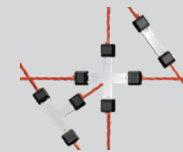
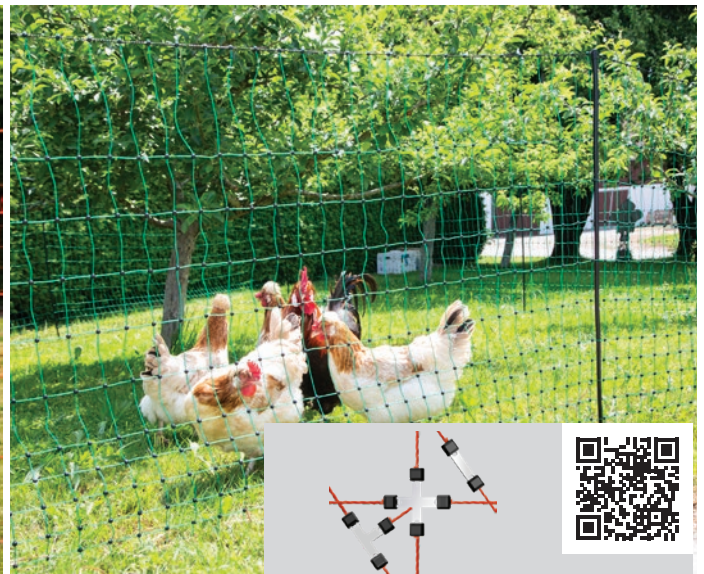

Simple and fast repairs due to our Litzclip® Repair Set

## PoultryNet

- for hens, geese, turkeys
- welded knots
- strengthened top strand
- particularly small mesh width in the lower area of the net
- sturdy plastic posts with galvanised ground spike
- also suitable for lambs
- available in electrifiable and non-electrifiable designs
- we offer a 3-year warranty against UV damage for all plastic wires

Made in the EU



3 year warranty of UV stability

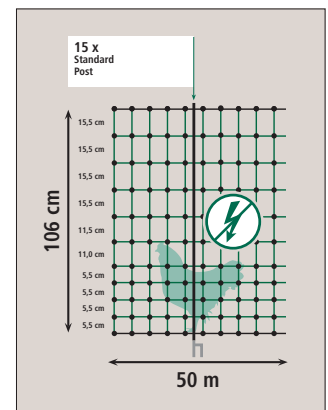
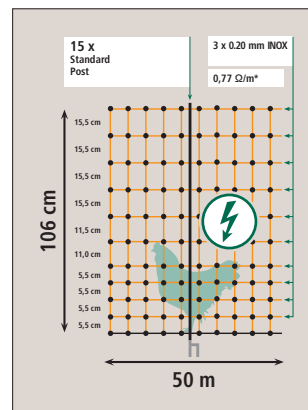

## PoultryNet

can be electrified

Ref. no.	Ground spike	Length	Height	Colour	Qty posts	Matching replacement post			€
292270	Single prong	50 m	106 cm	orange	15	292282-7	1	16	
292271	Double prong	50 m	106 cm	orange	15	292281-7	1	16	
292274	Double prong	15 m	106 cm	green	6	292281-5	1	40	
292273	Double prong	25 m	106 cm	green	9	292281-5	1	30	
292272	Double prong	50 m	106 cm	green	15	292281-5	1	16	

we recommend the use of electrifiable nets for turkeys and geese

## PoultryNet

not electrifiable

Ref. no.	Ground spike	Length	Height	Colour	Qty posts	Matching replacement post			€
292279	Double prong	25 m	106 cm	green	8	292281-5	1	30	
292276	Single prong	50 m	106 cm	green	15	292282-5	1	16	
292278	Double prong	50 m	106 cm	green	15	292281-5	1	16	

\* Based on the total conductor cross-section of all live poly wires in the pasture netting





A carefully thought-out concept and the range of products compiled by experts makes this set a real worry-free package!

## PoultryNet All-In-One Kit Solar

The complete set, with all necessary components for installing an electrified mesh quickly and easily to protect poultry, dogs, cats or rabbits. With 0.4 Joules of charging energy in the solar-powered device and a close-meshed net, the animals being protected and garden are safe.

- no time-consuming modular purchases, all parts required conveniently in one box
- Solar device with Joule input: 0.4 J with intelligent battery management with deep discharge protection: 2 weeks run time without sun and long battery life
- net with particularly small mesh width in the lower area, as well as stable plastic posts with galvanised bottom tip
- The set includes the matching ground post, a multi-level fence tester and all required cables. the set also includes the electric fence warning sign, which is always required and must be attached in a clearly visible place on the mesh
- can be set up and dismantled in just a few minutes without the need for any special tools

Set includes: 1 x poultry net green, 50 metres, height 106 cm, double prong (3-year warranty for UV resistance of the wire), 1 x Sun Power S 250 solar device, incl. 12 Volt, 3 Watt solar module, 1 x AGM battery, 12 Volt, 4 Ah (6-month warranty), 1 x 230 Volt power pack for recharging or battery maintenance during the winter months, 1 x ground connection cable (black), 1 x fence connection cable crocodile clip (red), 1 x earth rod, 1 x mesh repair kit, 1 x fence tester, 1 x warning sign, 1 x assembly instructions



Ref. no.			€
441154	1	12	



## PoultryNet All-In-One Kit 230 V

The all-round worry-free package, with all necessary components for installing an electrified mesh quickly and easily to protect poultry, dogs, cats, or rabbits. With 1.0 joule charging energy in the power supply and a close-meshed net, the animals to be protected and the garden are safe.

- no time-consuming modular purchases, all parts required conveniently in one box
- 230 Volt power supply with 1.0 Joule Input: compact device with unrestricted protection period thanks to mains operation
- net with particularly small mesh width in the lower area, as well as stable plastic posts with galvanised bottom tip
- The set includes the matching ground post, a multi-level fence tester and all required cables. the set also includes the electric fence warning sign, which is always required and must be attached in a clearly visible place on the mesh
- can be set up and dismantled in just a few minutes without the need for any special tools

Set includes: 1 x poultry net green, 50 metres, height 106 cm, double prong (3-year warranty for UV resistance of the wire), 1 x Fence Device 230 Volt Mains Operation Compact Power N 700 (5 year warranty), 2 x 10 m underground cable (for connecting the device to the net and the earthing), 1 x Wire Connecting Clamp (for Connecting Fence Supply Line and Pasture Net), 1 x earth rod, 1 x mesh repair kit, 1 x fence tester, 1 x warning sign, 1 x assembly instructions



Ref. no.			€
441155	1	12	





## RabbitNet



Extra-small mesh width guarantees maximum guarding safety!

### Rabbit Netting

can be electrified

Reliable protection for hares, rabbits and other small animals in the garden that is set up in moments. The extra-fine mesh makes the netting especially safe, while the galvanised ground spikes on the plastic posts ensure an excellent grip in the ground.

- freely configurable outlet for hares, rabbits and other small animals
- discreet green-black colouring fits in beautifully with any garden
- easy setup and dismantling thanks to integrated post with galvanised ground spike
- robust quality thanks to welded knots
- good electricity conduction via long-lasting stainless steel conductor
- extra-fine mesh to protect small animals or to keep unwanted visitors at bay
- we offer a 3-year warranty against UV damage for all plastic poly wires

372005



44657

3 year warranty of UV stability



Made in the EU

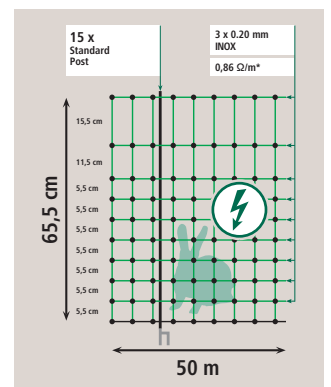

Ref. no.	Ground spike	Length	Height	Colour	Qty posts	Matching replacement post			€
292209	Single prong	12 m	65 cm	green	9	292210-5	1	40	
292216	Single prong	25 m	65 cm	green	9	292210-5	1	30	
292221	Single prong	50 m	65 cm	green	15	292210-5	1	16	
292222	Double prong	50 m	65 cm	green	15	292211-5	1	16	

Ref. no.	Description	Ground spike	Colour	Material	Post height		€
292210-5	Spare Post	Single prong	black	Plastic	65 cm	1/50	
292211-5	Spare Post	Double prong	black	Plastic	65 cm	1/50	
372005	Compact Power B 40		green / black			1	
27249-5	Head Insulator for Pasture Netting		black	Plastic		1/10/500	
27250-5	Base stopper for pasture netting		black	Plastic		1/10/500	
44657	Ground/Support Rod			galvanised metal		1	



## CampingNet



### Boundary fence Camping Net

The net is the perfect companion for camping holidays with dogs or other four-legged companions. Even small animals cannot fit through the narrow meshes. It can also be used to protect or demarcate flower beds, vegetable gardens and so on.

- for mobile fencing of camping pitches when pets or small animals are present
- as a border and protection for flower beds, vegetable gardens, green spaces, ponds
- fast and simple assembly and removal
- practical complete set incl. transport bag
- particularly narrow meshes in the lower net area ensure that even small animals cannot slip through
- the green net with black posts blends unobtrusively into the surroundings
- 9 sturdy plastic posts with galvanised ground nails
- we offer a 3-year warranty against UV damage for all plastic poly wires
- Mesh without electrification and therefore purely physical barrier without electricity

3 year warranty of UV stability



Made in the EU

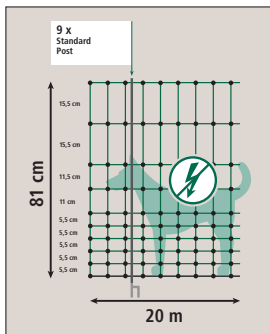

incl. handy transport bag



Ref. no.	Ground spike	Length	Height	Colour	Qty posts			€
292226	Single prong	20 m	80 cm	green	9	1	30	
292227	Double prong	20 m	80 cm	green	9	1	30	



## Twist Butler Netting Winder

The fantastic all-round helper for the day-to-day handling of pasture nets: it allows easy setup and dismantling of the nets and offers a handy solution for storage!

- easy and at the same time practical solution for setting up and dismantling pasture nets
- equivalent to a reel system for nets
- can be used for all nets up to 125 cm tall incl. ground nails and 50 m length
- the removable crank means that the rolled-up nets can be transported and stored standing up in a space-saving and orderly manner on the plates
- pasture nets can be handled daily without the use of force or outside help thanks to the Twist Butler

Made in Germany



Ref. no.	Description		€
27940	1 base element (plate and rod) with one crank	1	
27942	2 Base Elements (Plate and Rod)	1	

Ref. no.	Description		€
27941	single crank	1/31	

27941





## Support Post for Field Netting

- ideally suited as supporting start and end posts, or for stabilising corners of pasture netting
- The post is simply pushed into the corners, and the net is thereby tensioned
- solid post made of galvanised round steel (ø 14 mm), with foot lug
- Post tapered at the bottom for easier penetration into the earth
- Jacketing with robust plastic tube (ø 20 mm) prevents power leakage (if electrifiable nets are used)

Utility model application registered!



Ref. no.	Description	Total height	post Ø	Length ground nail	MOQ	Pieces / unit			€
27340	up to a height of 90 cm	120 cm	14 mm	25 cm	4 pieces	4 / pack	1/4	1,000	
27350	from a height of 90 cm	145 cm	14 mm	25 cm	4 pieces	4 / pack	1/4	500	



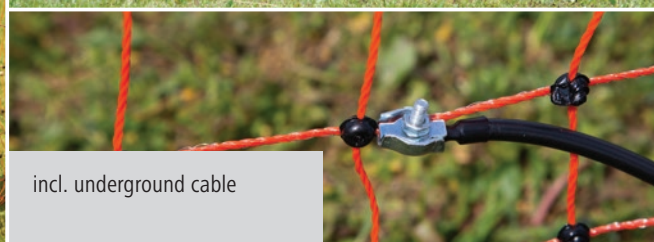

incl. underground cable

incl. connector accessories for optional electrification of the green net (the frame is insulated and can still be touched)



**Top Seller**

## Door for electric fence nets

can be electrified

Enables quick and easy passage through fence netting. Practical door for your electric netting. Quick and easy to install. Can be installed to any position on the netting - can also be installed subsequently to a fence that has already be set up. The green netting of the door is electrifiable, the stable frame is insulated. When opening the door, the power does not have to be turned off.

- fast and easy to open and close
- low weight, despite being sturdy and robust
- opening width: 86 cm (sufficient for most gardening equipment)
- incl. 2 jumbo standing posts, double-pointed
- electrifiable, incl. cable and connections
- quick and easy installation
- delivery includes connection and connection accessories

446517: suitable for all nets up to 106 cm in height

446518: extra-high version, suitable for a net height of over 95 cm up to 125 cm.

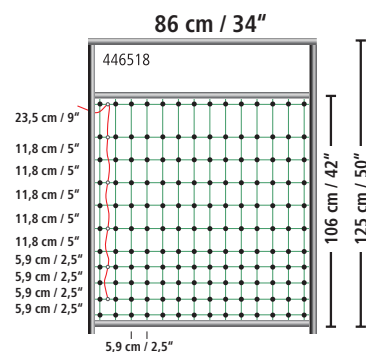
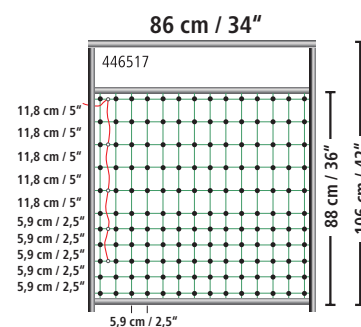

Ref. no.	Description	Width	Height		€
446517	for nets up to 106 cm	86 cm	106 cm	1	
446518	for nets from 95 - 125 cm	86 cm	125 cm	1	





# Netting Door Kit



## Complete net-door kit

This gate handle kit allows you to expand your fence with an easy-to-open gate that allows quick access to your animals on your pasture or in your garden.

- the kit is easy to handle and install: it fits on net posts with a diameter of 11 mm to 19 mm, supports all types of pasture netting and is compatible with electric and non-electric netting
- in a few minutes, a cut-through can be created in your netting fence that is as customised as your net itself and the gate therefore fits all possible widths and nets
- if the netting is electrified, the current does not need to be switched off to enter the pasture or to gain access to your animals: the extremely sturdy and generous handle allows you to walk through the gap in the fence without removing the electrification from the netting
- perfectly coordinated components made from long-lasting materials create a simple and flexible solution for every net
- simply mount on the first and last netting post and thereby create an easy-to-open, customised cut-through between the net ends
- Netting and netting posts not included in the scope of delivery



New product

NEW

Set consisting of:  
 2 x handle halves,  
 1 x foot anchor,  
 2 x netting post hooks,  
 3 x foot anchor pegs,  
 2 x guy ropes,  
 2 x guy pegs



Ref. no.		€
446532	1/12	

# Litzclip® The new way of repairing nets quickly.



- no tools required for mounting
- continuous electrification
- easy handling
- secure connection

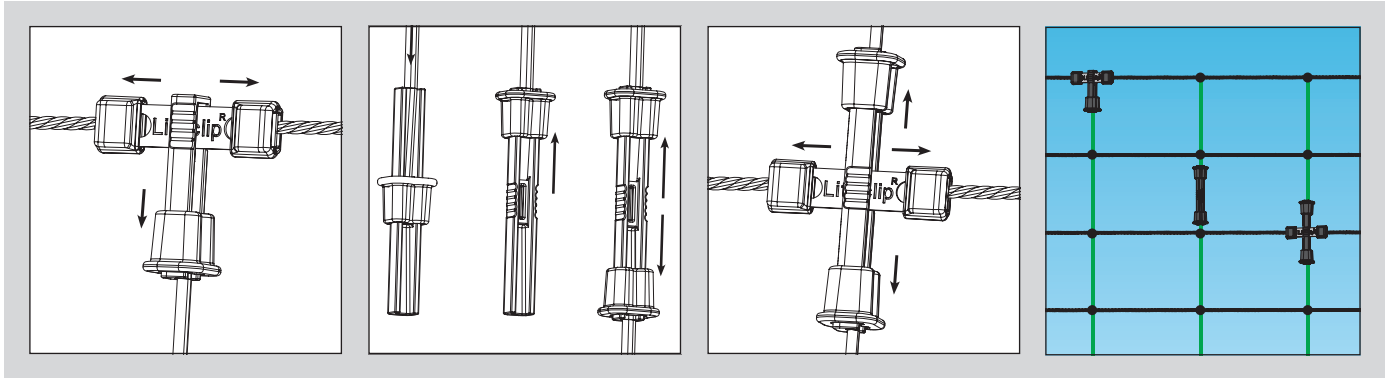
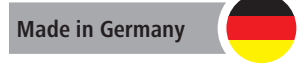

## Litzclip® Vertical Brace Connector for Pasture Nets

- the simple solution for repairing broken vertical struts in pasture nets

Suitable for all standard electric fence systems with rigid vertical struts!

patented



Ref. no.	Description	MOQ	Pieces / unit		€
442005/101	straight	1 pack	10 / pack	1/100	

## Litzclip® Repair set for vertical struts in pasture nets

- the simple solution for repairing broken vertical struts in pasture nets
- connector plate made from stainless steel

Suitable for all standard electric fence systems with rigid vertical struts!

patented

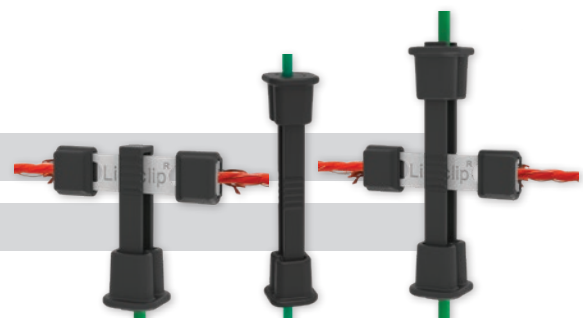

Ref. no.	Material	Pieces / unit		€
442020/081	stainless steel	1 / pack	1/100	

Set includes: 2 x connector straight, 2 x cross connector, 2 x T-connector



## Poly Wire Connector Litzclip®

- the straightforward solution, even for repairing a torn poly wire
- special key-shaped punched opening for the easy introduction and secure fixing of the poly wire

patented





Ref. no.	Material	can be used for	MOQ	Pieces / unit		€
442003/101	stainless steel	Poly wire up to Ø 3 mm	1 pack	10 / pack	1/100	

## Poly wire T-Connector Litzclip®

- suitable for use with all types of poly wire nettings

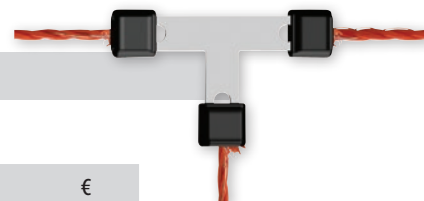
patented



Ref. no.	Material	can be used for	MOQ	Pieces / unit		€
442015/056	stainless steel	Poly wire up to Ø 3 mm	1 pack	5 / pack	1/100	

## Poly wire cross-connector Litzclip®

- suitable for use with all types of poly wire nettings

patented

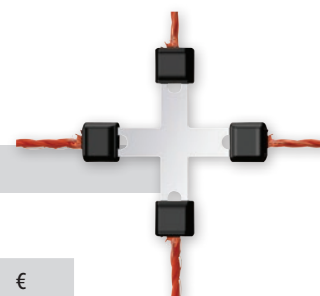

Ref. no.	Material	can be used for	MOQ	Pieces / unit		€
442014/056	stainless steel	Poly wire up to Ø 3 mm	1 pack	5 / pack	1/100	

## Litzclip® Repair Set

- especially for repairing sheep, poultry and rabbit netting

patented

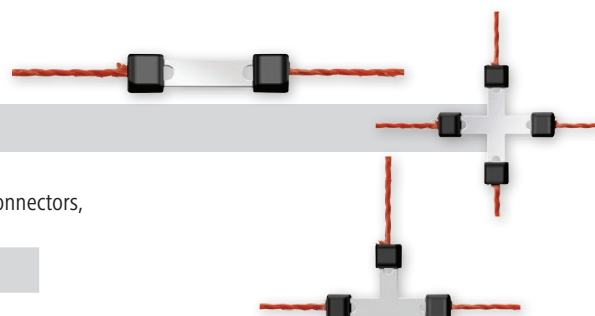

Set includes: incl. 4 x straight 3 mm poly wire connectors, incl. 2 x 3 mm poly wire cross-connectors, incl. 2 x 3 mm poly wire T-connectors

Ref. no.	Material	MOQ	Pieces / unit		€
442018/081	stainless steel	1 pack	6 / pack	1/100	





Ref. no.	Description	Ground spike	Colour	Material	Post height		€
27299	Connector clip for pasture netting					1	
27249-5	Head Insulator for Pasture Netting		black	Plastic		1/10/500	
27250-5	Base stopper for pasture netting		black	Plastic		1/10/500	
27322	Floor Anchor		black	Plastic		1/10/300	
27293	sheep netting repair set		orange			1/100	
27294	sheep netting repair set		green			1/100	
27804	Spare Post	Single prong	blue	thermoplastic + fibreglass	90 cm	1/50	
27805	Spare Post	Double prong	blue	thermoplastic + fibreglass	90 cm	1/50	
27806	Spare Post	Single prong	blue	thermoplastic + fibreglass	108 cm	1/50	
27807	Spare Post	Double prong	blue	thermoplastic + fibreglass	108 cm	1/50	
27346	Spare Post	Single prong	green	Plastic	90 cm	1/50	
27347	Spare Post	Double prong	green	Plastic	90 cm	1/50	
27348	Spare Post	Single prong	green	Plastic	108 cm	1/50	
27349	Spare Post	Double prong	green	Plastic	108 cm	1/50	
27202	Spare Post	Single prong	white	Plastic	90 cm	1/100	
27203	Spare Post	Double prong	white	Plastic	90 cm	1/50	
27229	Spare Post	Single prong	white	Plastic	108 cm	1/50	
27230	Spare Post	Double prong	white	Plastic	108 cm	1/50	
27201	Spare Post	Single prong	yellow	fibreglass	105 cm	1/50	
27301	Spare Post	Single prong	yellow	Plastic	90 cm	1/50	
27303	Spare Post	Double prong	yellow	Plastic	90 cm	1/50	
27305	Spare Post	Single prong	yellow	Plastic	108 cm	1/50	
27304	Spare Post	Double prong	yellow	Plastic	108 cm	1/50	
27277	Spare Post	Double prong	black	Plastic	90 cm	1/50	
27279	Spare Post	Double prong	black	Plastic	108 cm	1/50	
27217	Spare Post	Single prong	blue	fibreglass	90 cm	1/10	



27250-5  
Replacement Floor Stopper



27249-5  
Spare head insulator



27322  
Floor Anchor



Ref. no.	Description	Ground spike	Colour	Material	Post height		€
27299	Connector clip for pasture netting					1	
27249-5	Head Insulator for Pasture Netting		black	Plastic		1/10/500	
27250-5	Base stopper for pasture netting		black	Plastic		1/10/500	
27322	Floor Anchor		black	Plastic		1/10/300	
27804	Spare Post	Single prong	blue	thermoplastic + fibreglass	90 cm	1/50	
27805	Spare Post	Double prong	blue	thermoplastic + fibreglass	90 cm	1/50	
27806	Spare Post	Single prong	blue	thermoplastic + fibreglass	108 cm	1/50	
27807	Spare Post	Double prong	blue	thermoplastic + fibreglass	108 cm	1/50	
27808	Spare Post	Single prong	blue	thermoplastic + fibreglass	122 cm	1/50	
27809	Spare Post	Double prong	blue	thermoplastic + fibreglass	122 cm	1/50	
27375	Spare Post	Double prong	white	Plastic	122 cm	1/50	
27376	Spare Post	Single prong	white	Plastic	122 cm	1/50	
27360	Spare Post	Double prong	white	Plastic	145 cm	1/25	



Ref. no.	Description	Ground spike	Colour	Material	Post height		€
27299	Connector clip for pasture netting					1	
27249-5	Head Insulator for Pasture Netting		black	Plastic		1/10/500	
27250-5	Base stopper for pasture netting		black	Plastic		1/10/500	
27322	Floor Anchor		black	Plastic		1/10/300	
292401	Spare Post	Double prong	grey	thermoplastic + fibreglass	106 cm	1/50	
292407	Spare Post	Single prong	grey	thermoplastic + fibreglass	122 cm	1/50	
292408	Spare Post	Double prong	grey	thermoplastic + fibreglass	122 cm	1/50	
292282-7	Spare Post	Single prong	orange	Plastic	106 cm	1/50	
292281-7	Spare Post	Double prong	orange	Plastic	106 cm	1/50	
292282-5	Spare Post	Single prong	black	Plastic	106 cm	1/50	
292281-5	Spare Post	Double prong	black	Plastic	106 cm	1/50	



Ref. no.	Description	Ground spike	Colour	Material	Post height		€
27299	Connector clip for pasture netting					1	
27249-5	Head Insulator for Pasture Netting		black	Plastic		1/10/500	
27250-5	Base stopper for pasture netting		black	Plastic		1/10/500	
27322	Floor Anchor		black	Plastic		1/10/300	
292210-5	Spare Post	Single prong	black	Plastic	65 cm	1/50	
292211-5	Spare Post	Double prong	black	Plastic	65 cm	1/50	
292196	Spare Post	Single prong	black	Plastic	77 cm	1/50	



## Index

<b>2</b>	230 Volt Power Pack . . . . .	45
	230 Volt Power Pack for 9 Volt Battery Units . . . . .	70
<b>3</b>	32 Premium AGM Battery . . . . .	82
<b>7</b>	7 x 7 m Tournament / Paddock Set . . . . .	79
<b>A</b>	A 1200 Mobil Power . . . . .	51
	A 2000 Power . . . . .	53
	AD 2000 digital Mobil Power . . . . .	47
	AD 3000 digital Mobil Power . . . . .	47
	AD 5000 digital Mobil Power . . . . .	47
	Adaptor Cable . . . . .	69
	AKOtronic 57K . . . . .	38
	Allgäu Winder Insulator . . . . .	165
	ALU GUARD Fence Wire . . . . .	121
	AN 4000 Mobil Power . . . . .	49
	AN 550 Compact Power . . . . .	77
	AN 6000 Mobil Power . . . . .	49
	Angular Steel Post . . . . .	146
	Anti-Theft-Box . . . . .	67
<b>B</b>	B 290 Power Shock . . . . .	73
	B 40 Compact Power . . . . .	77
	B 500 plus Power Shock . . . . .	73
	B180 Compact Power . . . . .	75
	B260 multi Compact Power . . . . .	75
	B450 Compact Power . . . . .	6, 75
	Basic Plastic Post . . . . .	158
	Battery Charger . . . . .	80
	Battery Tester . . . . .	82
	BD 300 digital Power Station . . . . .	71
	BD 400 digital Power Station . . . . .	71
	BD 600 digital Power Station . . . . .	71
	Bentonit Earthing mix . . . . .	89
	Big Euro Reel . . . . .	97
	Boundary fence Camping Net . . . . .	230
<b>C</b>	Camping Net Boundary fence . . . . .	230
	Cavallo Tape Corner Insulator . . . . .	166
	Cavallo Tape Corner Insulator . . . . .	143, 173
	Chain tensioner . . . . .	127
	Charge insulator for round and oval steel posts . . . . .	175
	ClassicNet . . . . .	214
	Clip Insulator Premium . . . . .	167
	Clip Insulator . . . . .	173
	Clip Insulator Easy Tape . . . . .	168
	Clip Insulator Maxi Tape . . . . .	168
	Closing Option for Pasture Gate Mounting Set . . . . .	194
	Combi Insulator Premium . . . . .	165, 179
	Compact Power AN 550 . . . . .	77
	Compact Power B 40 . . . . .	77
	Compact Power B180 . . . . .	75
	Compact Power B260 multi . . . . .	75
	Compact Power B450 . . . . .	6, 75
	Compact Power N 700 . . . . .	77
	Compact Reel . . . . .	98
	Compact Ring Insulator . . . . .	163
	Compact Wide Tape Insulator . . . . .	169
	Complete net-door kit . . . . .	233
	Connector for Pasture Panels . . . . .	198
	Corner / Strain Insulator . . . . .	171
	Corner insulator . . . . .	168

Corner Insulator for Wire and Rope . . . . .	171
Corner insulator Premium . . . . .	143, 171, 172
Corner Solution for Fixed Fences . . . . .	125
Corner/Stretch Insulator Premium . . . . .	166
Cover for Pasture Gates . . . . .	194
Crocodile Clip . . . . .	93
Cut-Out Switch . . . . .	94

<b>D</b>	De-tensioning Isolator for Electric Rope 171	
	De-tensioning Set „Diagonal“ . . . . .	125
	De-tensioning Set „Horizontal“ . . . . .	125
	Digital Defect Finder . . . . .	84
	Digital DUO Voltmeter . . . . .	84
	Distance insulator . . . . .	177
	Distance Insulator T-Post . . . . .	141
	Door for electric fence nets . . . . .	232
	Dry Battery . . . . .	83
	Dry Battery Alkaline 9 Volt . . . . .	83
	DUO Power Pack All Weather . . . . .	39
	Duo Power X 1000 . . . . .	43
	Duo Power X 1600 smart . . . . .	27
	Duo Power X 2500 . . . . .	43
	Duo Power X 4000 . . . . .	43
	Duo Power X 6000 smart . . . . .	27
	Duo Power Xi 8000 . . . . .	41
	Duo Power Xi 8000 smart . . . . .	27

<b>E</b>	E-Line Gate System . . . . .	189
	Earthing mix Bentonit . . . . .	89
	Easy Cord Rope Insulator . . . . .	170
	Easy Drill EDX Ring Insulator . . . . .	162, 163
	Easy Drill EDX Slit Insulators . . . . .	164
	Easy Drill SX green Ring Insulator . . . . .	161
	Easy Tape Clip Insulator . . . . .	168
	EasyNet . . . . .	211
	Eco Euro Reel . . . . .	97
	Eco Gate System . . . . .	189
	Eco Plastic Post . . . . .	158
	EconomyLine Fencing Tape Double Pack . . . . .	108
	EconomyLine Monowire . . . . .	115
	EconomyLine Poly Wire . . . . .	114
	EconomyLine Polywire cross-wound . . . . .	115
	EconomyLine Rope . . . . .	111
	EconomyLine Tape . . . . .	108
	Electric Cattle Gate Electro Gate . . . . .	190
	Electrics Kit for Fence Gates . . . . .	195
	Electro Gate Electric Cattle Gate . . . . .	190
	Euro Cord Rope Insulator . . . . .	170
	Euro Reel . . . . .	97
	Euro Reel Big . . . . .	97
	Euro Reel Eco . . . . .	97
	Euro Tape Insulator . . . . .	169
	Expert Plastic Post . . . . .	156
	Extension Cable Set . . . . .	65
	Eyelet Metal Post . . . . .	147

<b>F</b>	Farming Forceps Standard . . . . .	127
	Fence-Checker . . . . .	86
	Fence Clip . . . . .	185
	Fence connection cable, double . . . . .	91, 92
	Fence Connection Cable, triple . . . . .	91, 92
	Fence Connector Cable Heart Clip . . . . .	93
	Fence Panel with Gate . . . . .	199
	Fence Power/Ground Connector Cable . . . . .	88
	Fence Starter Set T-Post . . . . .	139
	Fence Tester . . . . .	86
	Fence Tester with LED Display . . . . .	85
	Fence Tester, 8-tier . . . . .	86
	Fence Wire ALU GUARD . . . . .	121
	Fencing Tape Double Pack EconomyLine . . . . .	108
	Fin Tube Insulator . . . . .	127
	Fixing Clips for T-posts . . . . .	144
	FlexiGate . . . . .	187
	FlexiGate 19 m . . . . .	187

Fodder rack . . . . .	202
Four-sided manger for palisade feeding grid . . . . .	200

<b>G</b>	Gate / start insulator . . . . .	173
	Gate / start insulator for tapes Premium . . . . .	179
	Gate / start insulator Premium Vario . . . . .	178
	Gate / start insulator for tapes Premium . . . . .	178
	Gate / Tensioning Isolator TITAN . . . . .	181
	Gate Handle . . . . .	182, 183
	Gate Handle Premium . . . . .	182
	Gate Handle Premium BIG green . . . . .	183
	Gate Handle Premium with Litzclip® Tape Connector . . . . .	184
	Gate Handle Premium with Rope and Wire Connector . . . . .	185
	Gate Handle Soft Grip . . . . .	182
	Gate Handle with Litzclip® Connector . . . . .	184
	Gate Handle with Litzclip® Tape Connector 184 . . . . .	184
	Gate Handle with Rope and Wire Connector . . . . .	185
	Gate Handle with Tape Connector . . . . .	185
	Gate Insulator . . . . .	180
	Gate Insulator T-Post . . . . .	142
	Gate Insulator T-Post Vario . . . . .	142
	Gate Insulator X <sup>3</sup> . . . . .	180
	Gate Insulator X <sup>3</sup> Premium . . . . .	178
	Gate Lock . . . . .	188
	Gate Set Premium FLEXIGATE green 9, 186 . . . . .	186
	Gate Spring Kit . . . . .	188
	Gate System E-Line . . . . .	189
	Gate System Eco . . . . .	189
	Gear-toothed wire tensioner . . . . .	126
	Geared Reel 3:1 . . . . .	98
	Ground and Fence Connector Cable 91, 92 . . . . .	92
	Ground Connection Cable . . . . .	93
	Ground/Support Rod . . . . .	76

<b>H</b>	Hand Pile Driver . . . . .	131
	Hay Bell for Round Bales . . . . .	203
	Hay Net for Round Bales . . . . .	203
	Head Insulator T-Post . . . . .	140
	Head Insulator Tape/Rope Corner Solution T-Post . . . . .	140
	Herd Protection Band . . . . .	215
	High-power on/off switch . . . . .	94
	High Energy Saline dry Battery 9 Volt . . . . .	82
	High Voltage Cable Connector . . . . .	88
	High Voltage Underground Cable . . . . .	87, 88
	High Voltage Underground Cable Premium 87 . . . . .	87
	Highland Permanent Fencing Insulator 170 . . . . .	170
	Hobby Square hay rack . . . . .	201
	Hobbysset . . . . .	78

<b>I</b>	Insulator . . . . .	161, 162
	Insulator Euro Tape . . . . .	169
	Insulator for double wire mesh fence . . . . .	177
	Insulator Pinlock . . . . .	170
	Iron Wire . . . . .	122

<b>L</b>	Lightning Protection . . . . .	94
	Lightning protection device . . . . .	94
	Litzclip® Poly Wire Connector . . . . .	117, 235
	Litzclip® Poly wire cross-connector . . . . .	235
	Litzclip® Poly wire T-Connector . . . . .	235
	Litzclip® Rope Connectors . . . . .	117
	Litzclip® Safety Link for Electric Rope . . . . .	117
	Litzclip® Tape Connectors . . . . .	116
	Litzclip® Tape Gate Handle Connector . . . . .	184
	Locking Spike for Pasture Gates . . . . .	195

Long-Handle Clip Insulator . . . . .	173, 176
--------------------------------------	----------

<b>M</b>	Maxi Tape Clip Insulator . . . . .	168
	Metal Battery Boxes . . . . .	67
	Metal Box Assembly Kit . . . . .	65
	Metal Post T-Post . . . . .	138
	Mobil Power A 1200 . . . . .	51
	Mobil Power AD 2000 digital . . . . .	47
	Mobil Power AD 3000 digital . . . . .	47
	Mobil Power AD 3000 digital Starter Kit 54 . . . . .	47
	Mobil Power AD 5000 digital . . . . .	47
	Mobil Power AN 4000 . . . . .	49
	Mobil Power AN 6000 . . . . .	49
	Mobil Power AN 6000 Starter Kit . . . . .	55
	Mobile horse fence . . . . .	224
	Monowire EconomyLine . . . . .	115
	Mounting Clamp for Round Posts . . . . .	173
	Mounting Set for Pasture Gates . . . . .	194
	Multi Post . . . . .	99, 148

<b>N</b>	N 1200 Power . . . . .	37
	N 3500 Power . . . . .	37
	N 4800 Power . . . . .	37
	N 5000 Power Profi . . . . .	35
	N 70 Power Profi . . . . .	7, 35
	N 700 Compact Power . . . . .	77
	Nail Insulator . . . . .	175
	NDi 10000 digital Power Profi . . . . .	33
	NDi 15000 digital Power Profi . . . . .	33
	Netting Winder . . . . .	231
	Ni 10000 Power Profi . . . . .	34
	Ni 7000 Power Profi . . . . .	35

<b>O</b>	OctoWood . . . . .	133
	Offset Pigtail Insulator . . . . .	177
	Offset Ring Insulator . . . . .	172, 176
	Offset Rope Insulator . . . . .	176
	Offset Tape Insulator . . . . .	176
	One-Hand Drop Aid . . . . .	96
	Oval Fibreglass Post . . . . .	151
	Oval Fibreglass Post Premium BLUE . . . . .	149
	OviNet . . . . .	213
	OviNet Maxi . . . . .	220
	OviNet Premium . . . . .	212

<b>P</b>	Panel cover penetration protection . . . . .	199
	Pasture Gate adjustable . . . . .	191, 192
	Pasture gate adjustable for horse owners . . . . .	193
	Pasture Gate not adjustable . . . . .	193
	Pasture Panel . . . . .	198
	Pasture Shelter Complete Set for Sheep and Goats . . . . .	197
	Permanent Fencing Insulator Highland 170 . . . . .	170
	Pinlock Insulator . . . . .	140
	Pinlock Insulator T-Post . . . . .	140
	Plastic Eyelets . . . . .	150
	Plastic Post . . . . .	158
	Plastic Post Basic . . . . .	158
	Plastic Post Eco . . . . .	158
	Plastic Post Expert . . . . .	156
	Plastic Post Premium . . . . .	152
	Plastic Post Titan . . . . .	154
	Plastic Post Titan Plus . . . . .	154
	Plastic Post with Stirrup Step . . . . .	152
	Plastic Reel Super . . . . .	96
	PlatinumLine Poly Wire . . . . .	11, 103
	PlatinumLine Rope . . . . .	103
	PlatinumLine Tape . . . . .	10, 102
	Poly Wire Connector Litzclip® . . . . .	117, 235
	Poly wire cross-connector Litzclip® . . . . .	235
	Poly Wire EconomyLine . . . . .	114
	Poly Wire on Reel . . . . .	97

Poly Wire PlatinumLine	11, 103
Poly Wire Premium Ultra	112
Poly Wire Premium WildHog	113
Poly Wire PremiumLine	112
Poly Wire Steuer	115
Poly wire T-Connector Litzclip®	235
Poly Wire TopLine Plus	113
polyamide de-tensioning insulator for steel wire	171
Polywire cross-wound EconomyLine	115
Porcelain Corner Insulators	128
Porcelain Strain Insulator	128
Portable Fence Kit for Trekking	78
Post Hole Digger	130
PoultryNet All-In-One Kit 230 V	228
PoultryNet All-In-One Kit Solar	228
PoultryNet Premium	226
Power A 2000	53
Power N 1200	37
Power N 3500	37
Power N 4800	37
Power Pack All Weather DUO	39
Power Profi N 5000	35
Power Profi N 70	7, 35
Power Profi NDi 10000 digital	33
Power Profi NDi 15000 digital	33
Power Profi Ni 10000	34
Power Profi Ni 7000	35
Power Shock B 290	73
Power Shock B 500 plus	73
Power Station BD 300 digital	71
Power Station BD 400 digital	71
Power Station BD 600 digital	71
Power Station XDi 10000 smart	26
Power Station XDi 15000 smart	26
Premium AGM 15 Ah Complete Set	82
Premium AGM Battery	81
Premium AGM Battery 32	82
Premium BIG green Gate Handle	183
Premium BIG Ring Insulator	163
Premium BLUE Oval Fibreglass Post	149
Premium Clip Insulator	167
Premium Combi Insulator	165, 179
Premium Corner insulator	143, 171, 172
Premium Corner/Stretch Insulator	166
Premium FLEXIGATE green Gate Set 9, 186	
Premium Gate / start insulator for tapes	179
Premium Gate Handle	182
Premium High Voltage Underground Cable 87	
Premium Horse Wire	123
Premium Light Rope	109
Premium Plastic Post	152
Premium Plus Tape	105
Premium Slit Insulators	164
Premium Tape/Rope Tensioner	167
Premium Ultra Poly Wire	112
Premium Vario Gate / start insulator	178
Premium WildHog Poly Wire	113
PremiumLine Poly Wire	112
PremiumLine Rope	109
PremiumLine Tape	104
Profi Spring Steel Post	146
Puller for T-Post	145
Pulse Flash	85

## Q

Quick rope/poly wire connector 119, 180, 181

## R

Rabbit Netting	229
Ram for T-Post	145
Rear side spacer insulator T-Post	141
Recycled Post Cross Profile	135
Recycling Post Round Profile	135
Recycling Post Square Profile	135
Reel Holder	99, 148
Reel Super Big	96

Repair Set	235
Repair set for vertical struts in pasture nets 234	
Ring Insulator	161, 162, 163, 172
Ring Insulator Compact	163
Ring Insulator Easy Drill EDX	162, 163
Ring Insulator Easy Drill SX green	161
Ring Insulator Premium BIG	163
Ring Insulator T-Post	141
Ring Insulator Vario Classic	174
Ring insulator with continuous support incl. screw-in screwdriver in robust stable/ construction bucket	9, 161
Rope / tape connector	90
Rope and Poly Wire Connectors	118
Rope and wire tensioner	114
Rope Connecting Cable	93
Rope Connector	93
Rope Connectors	118
Rope Connectors Litzclip®	117
Rope Corner Insulator T-Post	143
Rope EconomyLine	111
Rope Insulator Easy Cord	170
Rope Insulator Euro Cord	170
Rope Insulator T-Post	141
Rope PlatinumLine	103
Rope Premium Light	109
Rope PremiumLine	109
Rope TopLine Plus	110
Round Fibreglass Post	151
Round rack with 12 feeding slots	202
Round rack with 8 feeding slots	202

## S

S 1000 Sun Power	61
S 1500 Sun Power	59
S 2400 smart Sun Power	28
S 250 Sun Power	62
S 3000 Sun Power	59
S 3800 Sun Power	59
S 4000 smart Sun Power	28
S 500 Sun Power	61
Safety Link for Electric Rope Litzclip®	117
Saline dry Battery 9 Volt High Energy	82
Savanne 2000	50
Savanne 3000	50
Savanne 3000 Starter Kit	55
Screw Insulator Vario Plus	174
Screwdriver for Ring and Clip Insulator	162
Sheep Hurdle	196
Signalling Band	215
Sledge Hammer	131
Slit Insulators	164
Slit Insulators Easy Drill EDX	164
Slit Insulators Premium	164
Slow Feeding Net	200
Smart Satellite	25
smart Solar-PowerStation	29
Soft Grip Gate Handle	182
Solar-PowerStation smart	29
Solar Module 4 Watt	66
Solar Panel	64
Solar Set 5 Watt	66
Solar Unit	28, 59, 62
Spare battery	59, 61
Spare Insulator for Oval Steel Post	150
Spare Insulator/Additional Insulator	149
Spare spring	150
Special Earth Rod for Mobile Use	89
Special Ground Rod	89
Special Steel Wire for Fixed Fence	122
Special Wet Rechargeable Battery 12 Volt. 80	
Spiral Ground/Retaining Anchor	65
Spiral Ground/Retaining Anchor for Solar Units	57
Splint Insulator for Angled Steel Post	146
Spring Steel Post	146
Spring Steel Post Profi	146
Spring steel post with eyelets	147
Square Hay Rack for Horses with Safety Feeding Barrier	200
Square hay rack Hobby	201
square Hay Rack Standard with Self-Closing Feeding Grate for Hornless Cattle 201	
Stabiliser for Adjustable Pasture Gates	195
Stake iron	130
Standard Farming Forceps	127
Standard four-sided rack with palisade feeding grid	201
Staples	127
Starter Kit Mobil Power AD 3000 digital	54
Starter Kit Mobil Power AN 6000	55
Starter Kit Savanne 3000	55
Stem Eyelet Insulator	177
Steuer Poly Wire	115
Stranded Wire	121
Sun Power S 1000	61
Sun Power S 1500	59
Sun Power S 2400 smart	28
Sun Power S 250	62
Sun Power S 3000	59
Sun Power S 3800	59
Sun Power S 4000 smart	28
Sun Power S 500	61
Super Big Reel	96
Super Plastic Reel	96
Super plastic reel with handle and holder for mounting on stands	98
Supplementary Set for Pasture Nets Wolf-Stop	222
Support Post for Field Netting	231
Swing-Through Lock for Fence Gates	194

## T

T-Post Distance Insulator	141
T-Post Fence Starter Set	139
T-Post Gate Insulator	142
T-Post Head Insulator	140
T-Post Head Insulator Tape/Rope Corner Solution	140
T-Post Metal Post	138
T-Post Pinlock Insulator	140
T-Post Premium Tape Gate Insulator Set	142
T-Post Rear side spacer insulator	141
T-Post Ring Insulator	141
T-Post Rope Corner Insulator	143
T-Post Rope Insulator	141
T-Post Tape Insulator	140
T-Post Tape, Rope and Corner Insulator	143
T-Post Tape/Rope Corner Solution	142
T-Post Universal Clamp Set	144
T-Post Universal Clip Set	144
T-Post Variable Corner Solution Set	139
T-Post Vario Gate Insulator	142
Tape Connecting Cable	90
Tape connector 2-way	90
Tape connector 3-way	90
Tape Connectors	116
Tape Connectors Litzclip®	116
Tape Corner Insulator Cavallo	143, 166, 173
Tape EconomyLine	108
Tape Gate Handle Connector Litzclip®	184
Tape Gate Insulator Set T-Post Premium	142
Tape Insulator T-Post	140
Tape PlatinumLine	10, 102
Tape Premium Plus	105
Tape PremiumLine	104
Tape TopLine	107
Tape TopLine Plus	106, 107
Tape, Rope and Corner Insulator T-Post	143
Tape/Rope Corner Solution T-Post	142
Tape/Rope Tensioner Premium	167
Temperature Equalisation Spring	126
Tensioning Arm for Wire Tensioner	127
TITAN Gate / Tensioning Isolator	181
Titan Plastic Post	154
Titan Plus Plastic Post	154
TitanLight Net	210
TitanNet	209
TitanNet 145	221
TitanNet Premium	208
TitanNet Premium Plus	217

TitanNet Premium Vario	218
TitanNet Premium XBraid	216
TopLine Horse Wire	124
TopLine Plus Poly Wire	113
TopLine Plus Rope	110
TopLine Plus Tape	106, 107
TopLine Tape	107
Tournament / Paddock Set 7 x 7 m	79

## U

Universal Clamp Set T-Post	144
Universal Clip Set T-Post	144

## V

Variable Corner Solution Set T-Post	139
Vario Classic Ring Insulator	174
Vario Gate / start insulator	178
Vario Plus Screw Insulator	174
Vario Wire Dispenser	122
Vertical Brace Connector for Pasture Nets	234

## W

Wall/floor Bracket for Pasture Panels	198
Warning Sign	95
Warning Sign – Caution Electric Fence!	95
Warning Sign – Electric Fence	95
Wide Tape Insulator	169
Wide Tape Insulator Compact	169
Wide Tape Ring Insulator	169
WildNet	223
Winder Insulator Allgäu	165
Wire connecting clamp	129
Wire Connectors	129
Wire Connectors Wire Link	129
Wire Dispenser	122
Wire Dispenser Vario	122
Wire Link Wire Connectors	129
Wire tensioner	127
WolfStop Supplementary Set for Pasture Nets	222
Wood Screw	160
Wooden Mallet	131
Wooden Post Mount	57

## X

X 1000 Duo Power	43
X 1600 smart Duo Power	27
X 2500 Duo Power	43
X 4000 Duo Power	43
X 6000 smart Duo Power	27
X <sup>3</sup> Gate Insulator	180
X <sup>3</sup> Premium Gate Insulator	178
XDi 10000 smart Power Station	26
XDi 15000 smart Power Station	26
Xi 8000 Duo Power	41
Xi 8000 smart Duo Power	27

## Z

Zinc-Carbon Dry Battery	83
-------------------------	----



# The electric fence module with a system from AKO

Our modular system is your best advisor! Informative and wellarranged product presentation makes choosing a lot easier:

- The characteristics that determine the decision to buy are listed on the packaging and shelf labelling
- For more information there are free catalogues and leaflets available.
- We offer selected product samples in special displays for a better „grasping“ of quality and design.

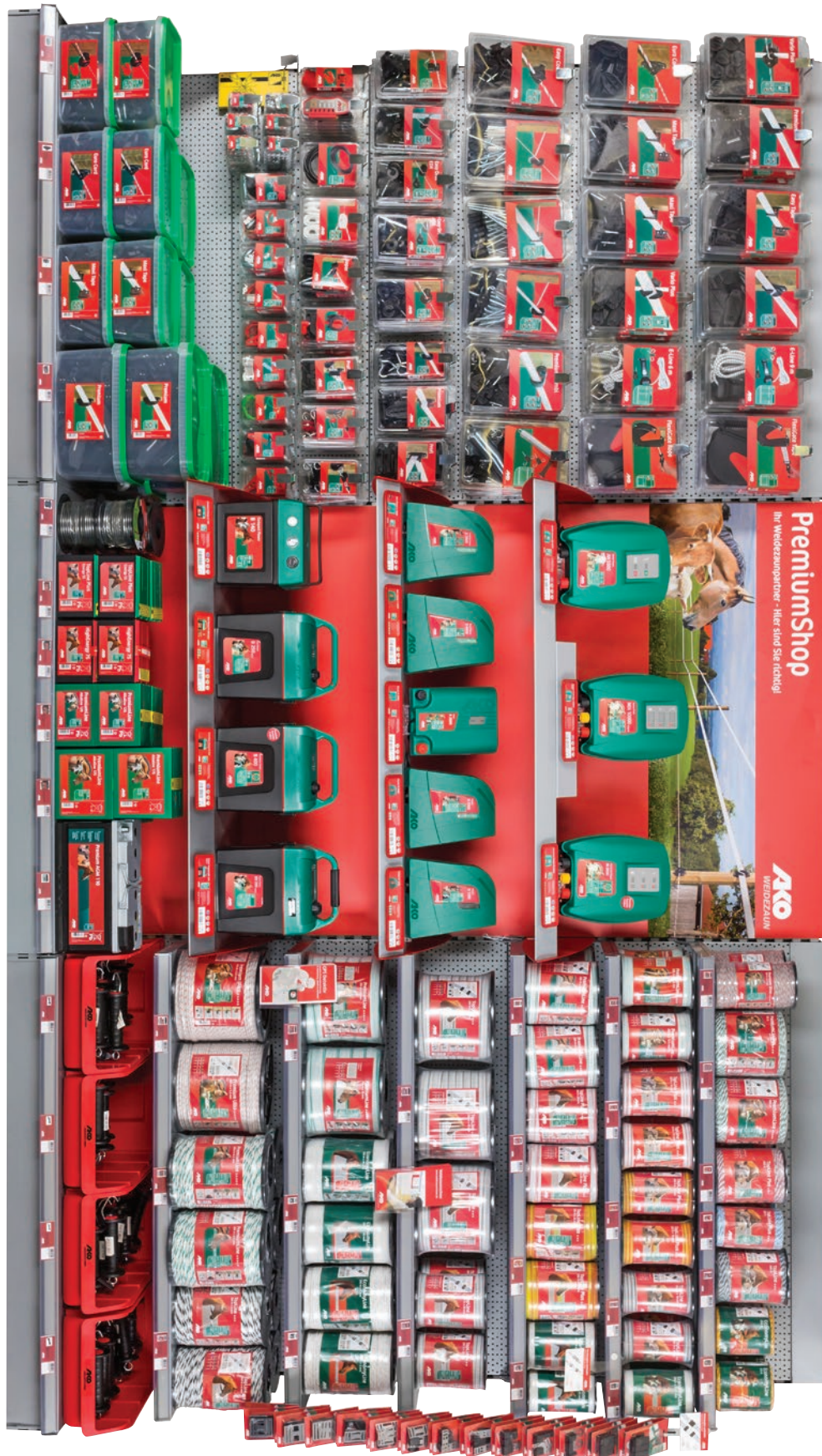



## AKO wild animal deterrent guide

From corn fields ruined by wild boar, fish ponds plundered by otters, or sheep taken by wolves – the topic of wild animal deterrent is not just a perennial issue, but also has additional, new, problematic facets. Electric fences have been proven to provide safe, long-term protection.

In our wild animal deterrent guide „Electric fence – a powerful argument! Wild animal freedom – but only until this point!“, we present an excerpt in words and pictures from our range of wild animal deterrent fence products, customised to the different wild animal types and their specific characteristics: proven practical solutions that ensure a successful and long-term protection function. Easy to understand graphics clarify the features of electric fence set-up, customised to respective wild animal types.

Browse our wild animal deterrent guide online or request your free copy by e-mail to [info@kerbl.com](mailto:info@kerbl.com) We are also happy to personally advise you via telephone at any time.



## AKO wolf defence guide

The spread of the wolf in the cultivated landscape holds a potential for conflict. As opportunist feeders, wolves snatch the animals which they can apparently capture most easily. These are, above all, domestic animals such as sheep and goats. Appropriate measures to protect herds are therefore essential, in order to prevent losses.

Our compact guide is intended to provide you with the most important information, tips, and approaches for effective wolf defence, using electric fences, and also to help you in selecting the right products for the protection of your herd.

Browse our wolf defence guide online, or simply request your free copy by e-mail to [info@kerbl.com](mailto:info@kerbl.com)! We are also happy to personally advise you via telephone at any time.



## AKO tips & tricks for building your own horse paddock

This guide is designed to assist you with the DIY installation of your individual fence system using AKO OctoWood wooden posts and/or T-Post metal posts. In order to get an initial overview of all required fence components, along with the cost, you can enter your paddock fence in our AKO fence calculator, [www.fenceconfigurator.com](http://www.fenceconfigurator.com), and generate a material requirements overview.

Browse our guide online or request your free copy by e-mail to [info@kerbl.com](mailto:info@kerbl.com)! We are also happy to personally advise you via telephone at any time.





## New: 5 year warranty on all fence devices!

We are pleased to inform you that we are now offering an extended warranty of 5 years on all our electric fence devices. Trust in our quality and enjoy even more safety and reliability.



### Sales/logistics

#### Kerbl UK Limited

8 Lands End Way  
Oakham, Rutland  
LE15 6RF UK

Phone +44 01572 722558

Fax +44 01572 757614

E-Mail [enquiries@kerbl.co.uk](mailto:enquiries@kerbl.co.uk)

[www.kerbl.co.uk](http://www.kerbl.co.uk)

#### Albert Kerbl GmbH

Felizenzell 9  
84428 Buchbach  
Germany

Phone +49 8086 933-100

Fax +49 8086 933-500

E-Mail [fencing@kerbl.com](mailto:fencing@kerbl.com)

[www.kerbl.com](http://www.kerbl.com)

### Product information/technical advice

#### AKO Agrartechnik GmbH & Co.KG

Karl-Maybach-Str. 4  
88239 Wangen-Geiselharz  
Germany

Phone +49 7520 9660-0

Fax +49 7520 9660-88

E-Mail [info@ako-agrar.com](mailto:info@ako-agrar.com)

[www.ako-agrar.com](http://www.ako-agrar.com)



We are constantly striving to improve our stock of products and keep them right up to date. We reserve the right to make design changes. The publication of this catalogue renders all previous catalogues and prices lists for these products invalid.

All prices provided are the manufacturer's recommended retail prices and are inclusive of VAT. All information is subject to typesetting and printing errors.

Price alterations and errors reserved.

Colours and designs may vary due to printing processes. Reprinting – even just of extracts – is only permitted only with prior consent.

Batteries are accessory items and are therefore not included in the equipment's scope of delivery.

You can significantly improve the tending safety of your paddock with the products listed.

Local influences and conditions can affect your fence system, which is why absolute tending safety cannot be guaranteed.

The vendor offers no warranty that the fence system is secure against break-outs; in fact, the safety system should be improved with the electric fence device and corresponding accessories.

Retail only via specialist dealers.

© 12/2024

WK2025-201\_EN\_AKO\_ohne Preis